

Magellan™ 9900i

PRODUCT REFERENCE GUIDE



Omni-Directional Imaging Scanner

 **DATALOGIC**

Datalogic S.r.l.

Via S. Vitalino, 13

40012 Calderara di Reno (BO)

Italy

Tel. +39 051 3147011

Fax +39 051 3147205

© 2022-2023 Datalogic S.p.A. and /or its affiliates

All rights reserved. Without limiting the rights under copyright, no part of this documentation may be reproduced, stored in or introduced into a retrieval system, or transmitted in any form or by any means, or for any purpose, without the express written permission of Datalogic S.p.A. and/or its affiliates.

Owners of Datalogic products are hereby granted a non-exclusive, revocable license to reproduce and transmit this documentation for the purchaser's own internal business purposes. Purchaser shall not remove or alter any proprietary notices, including copyright notices, contained in this documentation and shall ensure that all notices appear on any reproductions of the documentation.

Electronic versions of this document may be downloaded from the Datalogic website (www.datalogic.com). If you visit our website and would like to make comments or suggestions about this or other Datalogic publications, please let us know via the "Contact" page.

Disclaimer

Datalogic has taken reasonable measures to provide information in this manual that is complete and accurate, however, Datalogic shall not be liable for technical or editorial errors or omissions contained herein, nor for incidental or consequential damages resulting from the use of this material. Datalogic reserves the right to change any specification at any time without prior notice.

Trademarks

Datalogic and the Datalogic logo are registered trademarks of Datalogic S.p.A. in many countries, including the U.S.A. and the E.U.

Magellan is a trademark of Datalogic S.p.A. or of Datalogic and/or its affiliates, registered in many countries, including the U.S. and the E.U. All-Weights, SmartSentry, and ScaleSentry are trademarks of Datalogic S.p.A. or of Datalogic and/or its affiliates, registered in the U.S.

Patents

See www.patents.datalogic.com for patent list.

TABLE OF CONTENTS

PREFACE	IX
About this Manual	ix
Manual Conventions	ix
Technical Support	x
Support Through the Website	x
Reseller Technical Support	x
CHAPTER 1. INTRODUCTION	1
Manual Overview	1
Scanner Overview	2
Features	2
Connectors and Ports	3
Physical Parameters	3
Scanning	3
EAS Tag Deactivation System	4
Weighing	4
Scale Sentry™ Option	5
Warm-Up Time	6
Electrical Specifications	7
Power Supply	7
Safety Precautions	7
Labeling	8
Agency Compliances	9
Bar Codes Supported	11
1D Symbologies	11
2D Symbologies	11
References	12
CHAPTER 2. SITE PREPARATION AND INSTALLATION	13
SECTION I. Pre-Installation Considerations	13
Ergonomic Recommendations	14
Checkstand Design	15
Site Requirements	16
Scanner Dimensions	21
SECTION II. Checkstand Preparation	24
Counter Cutout	24
SECTION III. Installation	30
Overview	30
1. Unpacking	30
2. Route & Connect Cables	31
3. Power up & Operational Verification	34
4. Integration with POS	38
5. Scanner In-Counter Installation	39
Optional Remote Scale Display	41
Placement/Installation	41
CHAPTER 3. OPERATION AND MAINTENANCE	45
Scanner Maintenance	45

Scanner Usage	45
Scanning Items	46
Proper Weighing Technique (Scale Models)	47
Deactivating Security Labels	48
Operational Controls	49
Operational Modes	49
Power-Up/Selftest & Pre-Operation	49
Operating Mode	50
Additional Functions	51
Programming	51
Diagnostic Mode	51
Scanner and Scale Reset	51
Scale Adjustments	51
Operational Maintenance	53
Cleaning	53
Vertical Scan Window Replacement	54
CHAPTER 4. PROBLEM ISOLATION	55
Diagnostic Procedures	56
Error Codes	56
Scale Error Reporting	59
Flowcharts	60
CHAPTER 5. CALIBRATION PROCEDURES	65
Description of Calibration Sequence	66
Motion Test	66
Automatic Zero Setting Test	67
Preparing the Scanner/Scale for Calibration	67
Calibrating the Scale (Pounds & Kilograms)	68
Calibration Verification (Pounds)	70
Increasing-Load Test (Phase 1)	70
Shift Test (6 Pounds Dual Interval ONLY)	71
Increasing-Load Test (Phase 2 Dual Interval)	72
Shift Test (10 Pounds)	72
Increasing-Load Test (Single Interval Phase 2/Dual Interval Phase 3)	73
Blanking Test	73
Decreasing-Load Test	74
Return to Zero Test	74
Calibration Verification (Kilograms)	75
Increasing-Load Test (Phase 1)	76
Shift Test Metric (2 Kilogram Dual Interval ONLY)	77
Increasing Load Test (Phase 2 Dual Interval ONLY)	78
Shift Test — Metric (5 Kilograms)	78
Increasing-Load Test (Single Interval Phase 2/Dual Interval Phase 3)	79
Blanking Test	79
Decreasing-Load Test	80
Return to Zero Test	80
CHAPTER 6. PROGRAMMING	81
Introduction to Label Programming	81
Understanding the Basics	81
Using a Bar Code Mask	81
Going Green	81
Bar Code Mask	82
Integrating the Scanner With Your Host System	83
Customizing Your Scanner's Operation	83
Programming Overview	84
Programming via Handheld Device	84
What Is Programming Mode?	84
Entering and Exiting Programming Mode.	84
Programming Session	85

Programming Sequence	86
LED and Beeper Indicators	88
If You Make a Mistake...	88
Test Mode	89
GENERAL SCANNER AND SCALE FEATURES.....	91
SCANNING FEATURES	92
1D Double Read Timeout	92
2D Double Read Timeout	93
Digital Watermark (DWM) Features	94
Digital Watermark (DWM) Enable	94
Digitally Watermarked (DWM) Double Read Timeout	95
Digital Watermark (DWM) Operation Mode	96
Digital Watermark (DWM) Data Format	97
Digital Watermark (DWM) 2D Time	98
Label Gone Timeout	99
Sleep Mode Timer	100
1D Inverse Read Control	101
2D Inverse Read Control	102
Illumination Control	102
2D Contrast Improvement	103
1D VL Shared Decode Timeout	104
LED and Beeper Indications	105
Good Read LED Idle State	105
Scanner Control Button Options	106
Power-up Tone Control	107
Good Read Beep Control	108
Good Read Beep Frequency	109
Good Read Beep Length	110
Good Read Beep Volume	111
Good Read When to Indicate	112
Scale Zero Button and Scale Indicator LED	113
Scale Sentry	114
Scale Sentry Block Weight Transmission	115
Scale Sentry Override Button	116
Scale Sentry Mode	117
Scale Sentry GRI Enable	118
Scale Sentry Adaptive Scale Indication State	119
Adaptive Scale LED Option	120
Scale Enable	121
Scale Diagnostics Mode	122
Scale Stale Weight Timeout	123
Scale Enforced Zero Return	124
Scale Interface Type	125
Scale Baud Rate	128
Scale Interface Settings	130
Scale Interface Options	131
ICL Scale Interface DC1 Character Delay	132
Team POS ICL Scale Mode Enable	133
Scale Calibration Notification	134
Scale Intercharacter Delay	135
Remote Display — Enable/Disable	136
Auxiliary USB Mode	137
USB Device Port Location	138
PIR / CT	139
EAS FEATURES	141
EAS Features — Sensormatic	142
EAS Mode	142
EAS Notification	144
EAS Security Level	145
EAS Good Beep Mode	146
EAS Beep Duration	147

EAS Retry Count	148
EAS Exception Button	149
EAS Deactivation Duration — Coupled	150
EAS Deactivation Duration — Retry	151
EAS Deactivation Duration — Exception	152
EAS Pre-Read Time	153
EAS Features — Checkpoint	154
ERI Active State	154
ERI Timeout	155
INTERFACE RELATED FEATURE	157
Interface Type	159
RS-232 Interface Selection	161
USB Interface Selection	162
IBM Interface Selection	163
Keyboard Interface Selection	164
Maximum Host-Transmitted Message Length	165
IBM Features	166
IBM Interface Options	166
IBM Scale Address	167
IBM Transmit Labels in Code 39 Format	168
46XX Number of Host Resets	169
46XX Label Slicing Control	170
46XX Maximum Label Slice Length	171
USB OEM Interface Options	172
USB OEM Additional Interface Options	173
USB OEM Scanner Device Type	174
RS-232 Features	175
RS-232 Baud Rate	175
RS-232 Number of Data Bits	177
RS-232 Number of Stop Bits	178
RS-232 Parity	179
RS-232 Hardware Control	180
RS-232 Intercharacter Delay	181
RS-232 Software Flow Control	182
RS-232 Ignore Host Commands	183
RS-232 TTL	184
RS-232 TTL Invert	185
RS-232 Beep on ASCII BEL	186
RS-232 Beep After Weigh	187
Beep on Not on File	188
RS-232 ACK NAK Enable	189
RS-232 ACK Character	190
RS-232 NAK Character	191
RS-232 Retry on ACK NAK Timeout	192
RS-232 ACK NAK Timeout Value	193
RS-232 ACK NAK Retry Count	194
RS-232 ACK NAK Error Handling	195
RS-232 Indicate Transmission Failure	196
Single Cable RS-232 Options	197
Single Cable RS-232 Scanner Only Protocol	198
Single Cable RS-232 RTS CTS Selection	199
Single Cable RS-232 Use BCC	201
Single Cable RS-232 Use ACK/NAK	202
Single Cable RS-232 Use STX	203
Set Single Cable RS-232 STX Character	204
Single Cable RS-232 Use ETX	205
Set Single Cable RS-232 ETX Character	206
Single Cable RS-232 Datalogic Extensions	207
Single Cable RS-232 Pacesetter Plus	208
USB Keyboard and Keyboard Wedge Features	209
USB Keyboard and Keyboard Wedge Intercharacter Delay	209

Keyboard Wedge No Keyboard Support	210
USB Keyboard and Keyboard Wedge Send Control Characters	211
USB Keyboard and Keyboard Wedge Country Mode	212
Keyboard Wedge Quiet Interval	216
USB Keyboard and Keyboard Wedge Caps Lock State	217
DATA EDITING	219
Data Editing Overview	220
Please Keep In Mind...	221
Case Conversion	221
Character Conversion	222
Global Prefix/Suffix	223
Global Prefix	223
Global Suffix	224
Global AIM ID Enable	225
Label ID	226
Label ID Control	226
Setting Label ID	227
1D Symbologies	227
2D Symbologies	232
Global Mid-Label ID	233
1D SYBOLOGY PROGRAMMING	235
1D Symbologies	235
Coupon Control	236
Coupon Label Priority Timer	236
UPC-A	237
UPC-A Enable	238
UPC-A Number System Character Transmission	239
UPC-A Check Character Transmission	240
UPC-A Minimum Read	241
Expand UPC-A to EAN-13	242
UPC-E Enable	243
UPC-E Number System Character Transmission	244
UPC-E Check Character Transmission	245
Expand UPC-E to UPC-A	246
Expand UPC-E to EAN-13	247
UPC-E Minimum Read	248
EAN-13 Enable	249
EAN-13 First Character Transmission	250
EAN-13 Check Character Transmission	251
EAN-13 ISBN Conversion Enable	252
EAN-13 Minimum Read	253
EAN-8	254
EAN-8 Enable	254
EAN-8 Check Character Transmission	255
Expand EAN-8 to EAN-13	256
EAN-8 Minimum Read	257
EAN-8 Minimum Segment Length	258
EAN-8 Guard Insertion	260
EAN-8 Guard Substitution	261
EAN-8/Jan-8 Both Guards Substitution	262
EAN-8 Stitch Exact Label Halves	263
EAN-8 Stitch Unlike Label Halves	264
EAN-8 Decoding Levels	265
Other UPC/EAN Options	266
In-Store Printed Label Minimum Read	267
UPC/EAN Reconstruction	268
UPC/EAN Correlation	269
UPC/EAN Guard Insertion	270
UPC/EAN Stitch Exact Label Halves	271
UPC/EAN Stitch Unlike Label Halves	272
UPC/EAN Minimum Segment Length	273

Price Weight Check	275
Enable EAN Two Label	277
EAN Two Label Minimum Read	278
EAN Two Label Combined Transmission	279
Addons	280
GTIN Enable	287
GS1 DataBar	288
DataBar Omnidirectional Enable	288
DataBar Omnidirectional/EAN-128 Emulation	289
DataBar Omnidirectional 2D Component Enable	290
DataBar Omnidirectional Minimum Read	291
DataBar Omnidirectional Double Read Timeout	292
DataBar Expanded Enable	293
DataBar Expanded EAN-128 Emulation	294
DataBar Expanded 2D Component Enable	295
DataBar Expanded Minimum Read	296
DataBar Expanded Length Control	297
DataBar Expanded Length 1	298
DataBar Expanded Length 2	299
DataBar Expanded Reverse Retry Enable	300
DataBar Limited	301
DataBar Limited Enable	301
DataBar Limited Minimum Read	302
DataBar Limited 2D Component Enable	303
DataBar Limited EAN128 Emulation Enable	304
Code 39 Enable	305
Code 39 Start Stop Character Transmission	306
Code 39 Check Character Calculation	307
Code 39 Check Character Transmission	308
Code 39 Full ASCII	309
Code 39 Minimum Read	310
Code 39 Correlation	311
Code 39 Length Control	312
Code 39 Length 1	313
Code 39 Length 2	314
Code 39 Stitching	315
Code 39 Require Margins	316
Code 32 Italian Pharmacode Enable	317
Code 32 Start Stop Character Transmission	318
Code 32 Check Character Transmission	319
Code 128 Enable	320
Code 128 Transmit Function Characters	321
Expand Code128 to Code 39	322
Code 128 Minimum Read	323
Code 128 Correlation	324
Code 128 Length Control	325
Code 128 Length 1	326
Code 128 Length 2	327
Code 128 Stitching	328
EAN-128 Enable	329
Interleaved 2 of 5 (I 2 OF 5) Enable	330
I 2 of 5 Check Character Calculation	331
I 2 of 5 Check Character Transmission	332
I 2 of 5 Minimum Read	333
I 2 of 5 Correlation	334
I 2 of 5 Length Control	335
I 2 of 5 Length 1	336
I 2 of 5 Length 2	337
I 2 of 5 Stitching	338
Codabar Enable	339
Codabar Start Stop Character Transmission	340

Codabar Start Stop Character Set	341
Codabar Start Stop Character Match	342
Codabar Check Character Calculation	343
Codabar Check Character Transmission	344
Codabar Minimum Read	345
Codabar Correlation	346
Codabar Length Control	347
Codabar Length 1	348
Codabar Length 2	349
Codabar Stitching	350
Codabar Require Margins	351
Code 93 Enable	352
Code 93 Minimum Read	353
Code 93 Correlation	354
Code 93 Length Control	355
Code 93 Length 1	356
Code 93 Length 2	357
Code 93 Stitching	358
MSI Enable	359
MSI Check Character Calculation	360
MSI Number of Check Characters	361
MSI Check Character Transmission	362
MSI Minimum Read	363
MSI Correlation	364
MSI Length Control	365
MSI Length 1	366
MSI Length 2	367
MSI Stitching	368
Standard 2 of 5 Enable	369
Standard 2 of 5 Check Character Calculation	370
Standard 2 of 5 Check Character Transmission	371
Standard 2 of 5 Minimum Read	372
Standard 2 of 5 Correlation	373
Standard 2 of 5 Length Control	374
Standard 2 of 5 Length 1	375
Standard 2 of 5 Length 2	376
Standard 2 of 5 Stitching	377
2D SYMBOLOGY PROGRAMMING	379
2D Symbologies	379
Data Matrix Enable	380
Data Matrix Length Control	381
Data Matrix Length 1, Length 2 Programming Instructions	382
GS1 Datamatrix Enable	383
PDF 417 Enable	384
PDF 417 Length Control	385
PDF 417 Length 1, Length 2 Programming Instructions	386
PDF 417 Read Option	387
Micro PDF 417 Enable	388
Micro PDF 417 Length Control	389
Micro PDF 417 Length 1, Length 2 Programming Instructions	390
Micro PDF 417 128 Emulation	391
QR Code Enable	392
QR Code Length Control	393
QR Code Length 1, Length 2 Programming Instructions	394
GS1 QR Code Enable	395
QR Code URL Link Enable	396
Micro QR Code Enable	397
Micro QR Code Length Control	398
Micro QR Code Length 1, Length 2 Programming Instructions	399
Aztec Enable	400
Aztec Length Control	401

Aztec Length 1, Length 2 Programming Instructions	402
APPENDIX A. LED/AUDIO INDICATIONS & CONTROLS	403
Good Read Indicators	403
Controls and Indicators	404
LED and Audio Indications	405
Scale Zero Button	407
Calibration Switch	407
APPENDIX B. CABLE INFORMATION	408
Introduction	408
General Specifications	408
External Cable Pinouts	409
Peripheral Ports / Connectors	410
APPENDIX C. KEYPAD.....	412
APPENDIX D. MICROSD CARD	414
MicroSDHC Compatibility	414
MicroSD Card Insertion	414
microSD Card Removal	415
Autorun File Processing	416
MicroSD Function Summary	416
MicroSD Function Details	417
From Scanner to MicroSD Card	417
From MicroSD Card to Scanner	419
APPENDIX E. HOST COMMANDS	420
Accepting Commands from an RS-232 Scanner Host	420
APPENDIX F. FACTORY DEFAULTS.....	422
APPENDIX G. HANDHELD DATA FORMAT REQUIREMENTS.....	438
Handheld Data Format Requirements General	438
Datalogic Handheld Data Format Requirements	439
AIM Formats	443

PREFACE

ABOUT THIS MANUAL

This Product Reference Guide (PRG) is provided for users seeking advanced technical information, including connection, programming, maintenance and specifications. The Quick Reference Guide (QRG) and other publications associated with this product are downloadable free of charge from the website listed on the back cover of this manual.

Manual Conventions

The following conventions are used in this document:

The symbols listed below are used in this manual to notify the reader of key issues or procedures that must be observed when using the reader:



NOTE: This symbol draws attention to details or procedures that may be useful in improving, maintaining, or enhancing the performance of the hardware or software being discussed.



CAUTION: This symbol advises you of actions that could damage equipment or property.



WARNING: This symbol advises you of actions that could result in harm or injury to the person performing the task.



HIGH VOLTAGE: This symbol alerts the user they are about to perform an action involving, either a dangerous level of voltage, or to warn against an action that could result in damage to devices or electrical shock.



LASER: This symbol alerts the user they are about to perform an action involving possible exposure to laser light radiation.



GROUNDING: This symbol advises you to pay particular attention to the grounding instructions for correct device functioning.



ESD: This symbol identifies a procedure that requires you take measures to prevent Electrostatic Discharge (ESD) e.g., use an ESD wrist strap. Circuit boards are most at risk. Please follow ESD procedures.

TECHNICAL SUPPORT

Support Through the Website

Datalogic provides several services as well as technical support through its website. Log on to (www.datalogic.com).

For quick access, from the home page click on the search icon , and type in the name of the product you're looking for. This allows you access to download Data Sheets, Manuals, Software & Utilities, and Drawings.

Hover over the Support & Service menu for access to Services and Technical Support.

Reseller Technical Support

An excellent source for technical assistance and information is an authorized Datalogic reseller. A reseller is acquainted with specific types of businesses, application software, and computer systems and can provide individualized assistance.

CHAPTER 1

INTRODUCTION

The Magellan 9900i is a multi-plane imaging bar code scanner with an optional integrated scale, designed to deliver best in class performance for assisted service checkout Lanes or Self-checkout lanes within Retail stores requiring high throughput and ease of use. In addition, this new Magellan portfolio includes multiple options to integrate smart color cameras and neural processors inside the scanner which enable Retail Artificial Intelligence capabilities that improve customer experience and reduce shrink.

This manual provides details for installation, configuration, calibration and operation of the scanner or scanner-scale.



NOTE: For the purposes of this manual, any Magellan 99xx model may be termed as simply “scanner” (including scanner-scale models).

Because of differences due to multiple model types and options, the illustrations shown in this manual may vary from the model(s) in use at your location.

MANUAL OVERVIEW

[Chapter 1, Introduction](#), presents the manual’s contents, describes features and specifications, provides regulatory and safety information, and lists the bar code symbologies the scanner will read.

[Chapter 2, Site Preparation and Installation](#), supplies physical dimensions for the scanner or scanner-scale and its most common accessories, and details counter preparation and installation. Cable routing, connection and testing are also explained in this section.

[Chapter 3, Operation and Maintenance](#), describes use and maintenance; providing details about operator controls, programming and diagnostic modes, scale “zeroing” and calibration. Scanner and scale routine maintenance are outlined in this section as well.

[Chapter 4, Problem Isolation](#), provides an outline of three scanner-scale test modes: Self-test, Operational Tests and Diagnostic Tests. Descriptions of the error indications if the scanner detects a system problem and troubleshooting flowcharts to aid in problem resolution are also presented.

[Chapter 5, Calibration Procedures](#), explains scale calibration and verification procedures, including procedures for calibrating the scale in pounds as well as kilograms.

[Chapter 6, Programming](#), and subsequent chapters detail procedures and provide custom bar codes for setting programmable scanner and scanner-scale features.

[Appendix A, LED/Audio Indications & Controls](#), lists the various functions and indications of the scanner’s control panel features.

[Appendix B, Cable Information](#), outlines wire requirements, connector specifications and pinout details for associated product cabling.

Appendix C, **Keypad**, furnishes bar codes representing the digits and characters required to enter extended programming data needed during certain programming sessions.

Appendix D, **MicroSD Card**, describes the use and functions of the microSD Card Slot.

Appendix E, **Host Commands**, contains a partial listing of available host commands that can be used with a compatible host interface.

Appendix F, **Factory Defaults**, provides a listing of factory default settings based on the most common interface.

Appendix G, **Handheld Data Format Requirements**, specifies additional references for use when a handheld scanner is connected to the scanner.

SCANNER OVERVIEW

Features

The parts and features of the scanner are shown in Figure 1. Control Panel buttons and indicators are described in more detail in Appendix A.



NOTE: Optional features include the Scale (for weighing items) Top Down Reader (TDR) and Electronic Article Surveillance (EAS). Your scanner may or may not support all of these capabilities.

Figure 1. Scanner Features

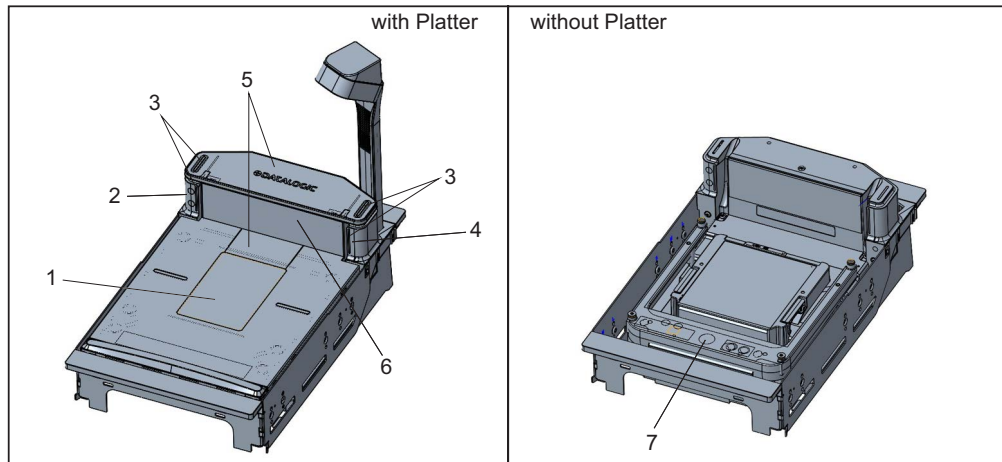

1	Horizontal Scan Window	5	All Weighs™ Platter
2	Control Panel	6	Vertical Scan Window
3	Good Read Indicator LED	7	Bubble Level (optional)
4	Speaker		

Connectors and Ports

Connector port availability and appearance will differ between models, since these optional features may sometimes be added at the time of purchase. Reference Figure 1 and the section entitled [2.2 Connect cables, starting on page 32](#).

- Checkpoint® Electronic Article Surveillance (EAS) Feature
- Sensormatic® Electronic Article Surveillance (EAS) Feature
- Scale (weighing) Feature
- Remote Display Accessory (for models with a scale)
- microSD Card Reader
- USB Service Port

PHYSICAL PARAMETERS

This section provides specifications for performance, environmental and electrical parameters. Reference the second section of this manual, [Site Preparation and Installation](#), for physical measurements of all models and some accessories.

Scanning

A scan zone (Figure 2) exists in the area between the horizontal and vertical scan windows. Separate projections from each of these sources combine to form a zone where bar code labels are read. Refer to the [Operation and Maintenance](#) section of this manual for more details about the topic: [Scanning Items](#).

Figure 2. Scan Zones

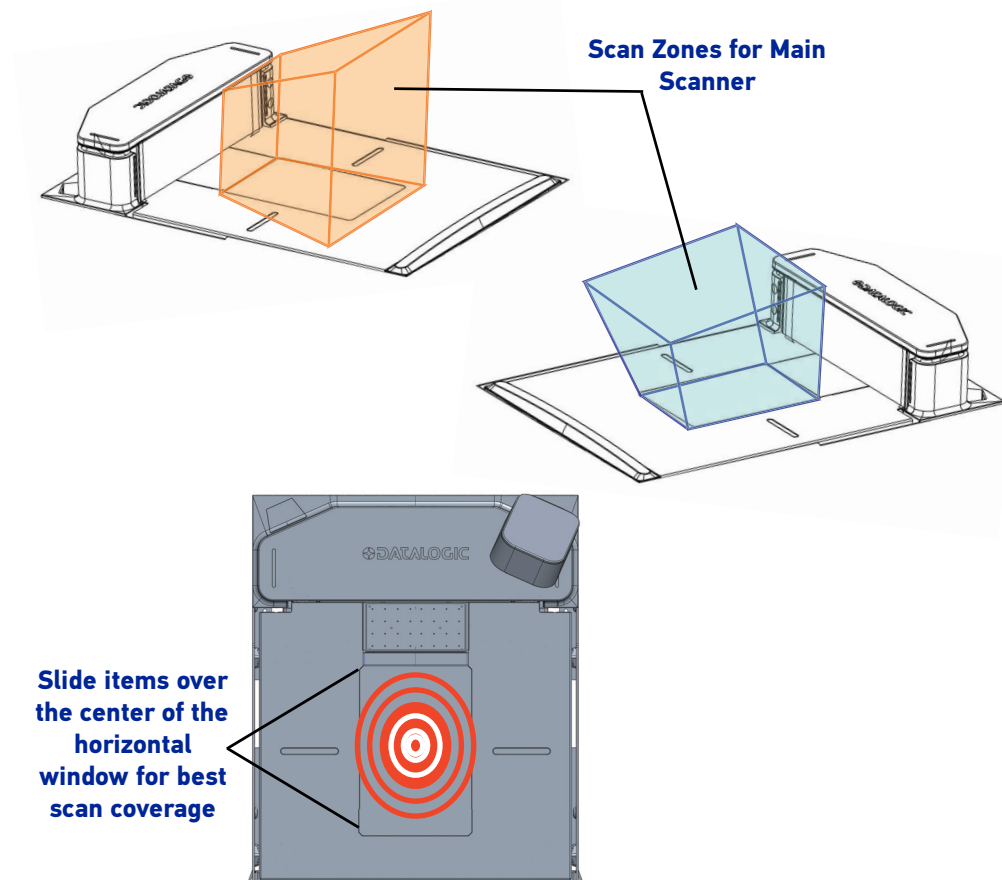

EAS Tag Deactivation System

Scanners can be ordered from the factory to include an optional EAS (Electronic Article Surveillance) deactivation system. Two different EAS system types are available: Checkpoint¹ and Sensormatic².

The Sensormatic[®] deactivation system requires connection as shown in [Chapter 3, Deactivating Security Labels](#).

Contact [for information](#) about installation of the Sensormatic AMB-9010 or ScanMax-Pro EAS controller box. Additional details about this system can be referenced under the following topics:

- [Chapter 3, Deactivating Security Labels](#)
- [Chapter 1, EAS Features — Sensormatic](#)

Weighing

Specifications for scale capacity, settling time, minimum and maximum static weight, zeroing, and warm-up time are given below. For more information regarding the topic: [Proper Weighing Technique \(Scale Models\)](#), refer to the [Operation and Maintenance](#) section of this manual.



NOTE: This function may not apply to Adaptive Scale models.

Rated Weight Capacity

The scale's operational weight capacity is:

- 30.00 pounds, displayed in 0.01 increments

-- OR --

- 15.000 kilograms³, displayed in 0.005 increments.

Minimum Weight

The minimum weight that can be accurately measured by the scale is 0.01 lb. (0.005 kg).

Maximum Static Weight (Overload)

A maximum static weight of 150 pounds (68 kg) can be sustained by the scale without incurring damage or degrading performance.

Automatic Zero Maintenance

The scale's software constantly monitors and adjusts the Zero point as long as the deviation is within acceptable limits⁴, while compensating for any debris accumulation or removal. During powerup, the scale automatically re-zeros after verifying that all sub-systems are functional. Additionally, the scale may be manually "zeroed" by pushing the Scale Zero Button located on the control panel.

The limits for zeroing with the button push are nominally +/- 0.60 lbs (+/- 0.300 kg). The limits for zeroing on powerup are nominally +6lbs - 0.60 lbs (+ 3kg - 0.300kg).

1. Checkpoint is a registered trademark of Checkpoint Systems, Inc

2. Sensormatic is a registered trademark of Sensormatic Electronics Corporation.

3. The scale can also be set at the factory for 9.99 kg max.

4. The acceptable limits of deviation should be -0.6 to 0.6 lbs (-0.3 to 0.3 kg), which is -2 to +2% of total capacity.

Scale Sentry™ Option

The optional ScaleSentry feature monitors items placed on the platter to ensure they are not overhanging and touching non-weighing surfaces. If the system's infrared (IR) beams sense items encroaching past the sides of the weigh platter, the speaker will sound a unique tone and/or the ScaleSentry LED indicator will illuminate to indicate a ScaleSentry error condition. ScaleSentry optionally blocks the transmission of weight to the host depending on how it is configured (see "Scale Sentry" starting on page 114). The scanner/scale can be programmed to just beep and/or light the LED if there is a ScaleSentry issue. Reference "Using the Optional ScaleSentry™ Feature" on page 47 for more ScaleSentry options and details.



NOTE: This function may not apply to Adaptive Scale models.

Warm-Up Time

There are two pertinent warm-up times that apply to the scanner-scale:



NOTE: The two warm-up periods can be performed concurrently, thereby reducing the total required warm-up time to 60 minutes.

Thermal Equilibrium

When the unit is moved from a cooler temperature (such as a storage area) to a warmer environment (such as a checkstand location), 60 minutes must be allowed to acclimate the unit to ambient conditions prior to calibration or operation.

Power-up

Once installed and powered up, a warm-up time of 15 minutes must be allowed before calibrating or performing weighing operations.

Figure 3. Environmental Specifications

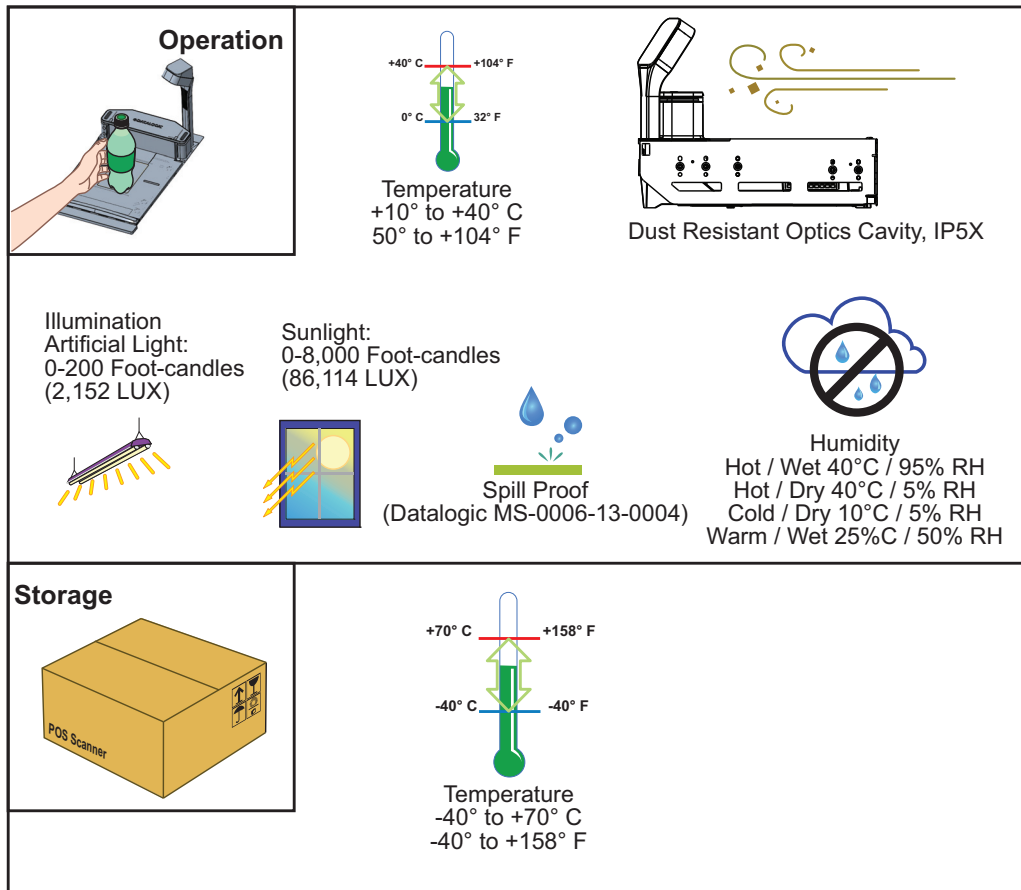

ELECTRICAL SPECIFICATIONS

Before installation, always verify that the site's electrical service meets the scanner's requirements. The scanner has been engineered for compatibility with most international electrical systems operating in ranges from 100 to 240VAC at 50-60 Hz. Verify that the power source will supply "clean" electrical power to the equipment; that is, it must be free of excess electrical noise.

Check the IEC power cord shipped with the scanner-scale. If the cord will not plug into your AC power receptacle, the power cord shipped is not compatible with your electrical system. Please contact your distributor immediately to receive the necessary information and components to ensure electrical compatibility.

Power Supply

The scanner utilizes a single power supply for all models. Unique installation and international connections are accomplished through selection of the proper IEC power cord.

VOLTAGE	FREQUENCY	CURRENT (RMS)
100-240VAC \pm 10%	50-60 Hz	0.5 Amps @ 100V



CAUTION: Safe operation of your scanner or scanner-scale requires properly grounded electrical outlets. Be sure to have a qualified electrician certify the earth-ground connection on circuits which will be used to power the unit.



NOTE: The scanner is powered on/off by connecting/disconnecting its power supply.

Safety Precautions



CAUTION: No adjustments or alteration of the scanner or scanner-scale housing are to be attempted by the user.



WARNING: This equipment has been tested and found to comply with the limits for a Class A digital device, pursuant to part 15 of the FCC Rules. These limits are designed to provide reasonable protection against harmful interference when the equipment is operated in a commercial environment. This equipment generates, uses, and can radiate radio frequency energy and, if not installed and used in accordance with the instruction manual, may cause harmful interference to radio communications. Operation of this equipment in a residential area is likely to cause harmful interference in which case the user will be required to correct the interference at his or her own expense.

This Class A digital apparatus meets all requirements of the Canadian Interference-Causing Equipment Regulations.

Cet appareil digital de classe A répond à toutes les exigences du Règlement sur le matériel brouilleur du Canada.

LABELING

Regulatory, reference and safety labeling are shown below.

Figure 4. Labeling

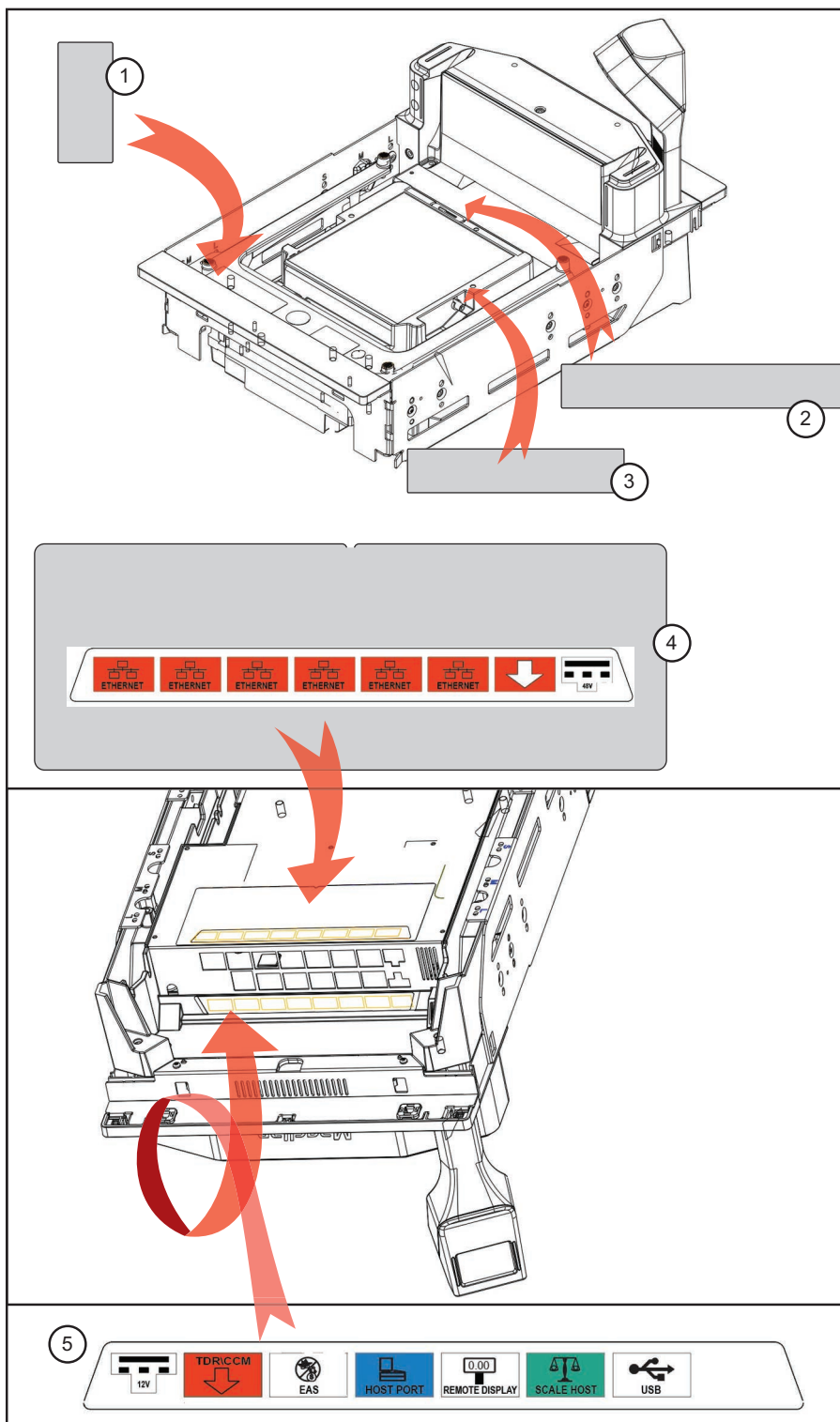

Beneath the Platter		Underside of Scanner	
1	Scale Regulatory Label (units with scales only)	4	Ethernet Switch I/F Label
2	Serial Number Label	5	Main Board I/F Label
3	Serial Number Label for Scale with Pre-Defined Gravity Zone (if applicable)		

AGENCY COMPLIANCES

The scanner and scanner-scale meets or exceeds the requirements for its device type as set forth by the following agencies and regulations:

COUNTRY	COMPLIANCE	COMMENTS
Safety		
United States	UL62368-1, 2 nd Ed	ULus Approved
Canada	CAN/CSA C22.2 No. 62368-1-14 2 nd Ed	cUL Approved
World	IEC62368-1:2014	CB certification
EMC/EMI		
United States	FCC part 15 subpart J	Class A
Australia/N Zealand	AS/NZS CISPR 32:2015 AMD 1:2020	Class A
Canada	ICES-003 issue 7:2020	Class A
Europe	EN 55032:2020, EN 55035:2017+A11:2020	Class A
Japan	VCCI-CISPR 32:2016	Class A
Optical Emissions		
Europe and ROW	E 62471:2006, EN62471:2008	LED illumination
Weights & Measures (Scale units only)		
United States	NIST Handbook 44, 2022 Edition, and NCWM Pub 14. 2022 Edition	NCWM-NTEP
Canada	Measurement Canada	In accordance with sections 14 and 15 of the Weights and Measures Regulations.
Europe	Directive 2014/31/EU	EN 45501:2015
Australia	National Measurement Institute (NMI)	NMI R76, Parts 1 and 2. Oct 2015
New Zealand	1999 Part 1	Regulations 5 and 6
Mexico	NOM-010-SCFI-1994	
United Kingdom		Follows Europe
Bureau International de Métrologie Légale (BIML)	OIML R76-1:2006	Class III scale, non-automatic weighing

COUNTRY	COMPLIANCE	COMMENTS
Power Supply		
USA/Canada	Safety	cULusa
State of California	CEC-400-2010-012	Energy Efficiency Standard
Canada	NR Canada	Energy Efficiency Standard
Europe	CE and Level IV efficiency	Safety, EMC and energy efficiency Erp2009/125 EEC
ROW	CB cert	CB Safety Scheme
Mexico	NOM and CONUEE	Safety and Energy Efficiency
Japan	PSE	Safety J62368-1 and EMC J55032
Russia	EAC	Safety
Australia	RCM and MEPS	Safety AS/NZS 62368-1 and AS.NZS 4665 (energy efficiency)
Korea	KCC and MEPS	Safety, EMC and Energy Efficiency
Taiwan	BSMI	Safety CNS 14336-1 and EMC CNS 13438
China	CCC	Safety and EMC
Argentina	IRAM S mark	Safety
India	BIS	Safety
South Africa	SABS	Safety
United Arab Emirates	ECAS	Safety
Morocco	C mark	Safety
United Kingdom	UKCA	Safety, EMC and RoHs

Contact Datalogic USA, Inc. or your Datalogic representative for a complete listing of approvals for other countries.



NOTE: Approvals and certifications are subject to change.

BAR CODES SUPPORTED

The scanner can read/decode the following 1D and 2D bar code types (symbolologies):

1D Symbolologies

- UPC Versions A & E
- Plural Stage Dual UPC Bar Codes for Japan (2 label read)
- GSI DataBar Omnidirectional, DataBar Expanded, DataBar Stacked
- EAN-8 & 13
- JAN-8 & 13
- UCC/EAN 128
- GTIN Support
- Code 39
- Code 39 full ASCII
- Code 128 (including conversion to Code 39)
- Code 93
- Interleaved 2 of 5 (I 2 of 5)
- Industrial 2 of 5 (sometimes referred to as Standard 2 of 5)
- Code 32 (Italian Pharmaceutical Code)
- Codabar
- MSI

2D Symbolologies

- PDF417, including driver's license parsing
- MicroPDF
- Data Matrix
- Aztec
- QR Code
- Micro QR

REFERENCES

U.S. Department of Labor
Guidelines for Retail Grocery Stores
www.osha.gov

Anonymous, 1992, "Ergonomic Improvement of Scanning Checkstand Designs"
Food Marketing Institute
800 Connecticut Ave. N.W.
Washington, D.C. 20006

Grant, Katharyn A. et al., 1992, "Ergonomic Evaluation of Checkstand Designs in the Retail Food Industry"
National Institute of Occupational Safety and Health
4676 Columbia Parkway
Cincinnati, Ohio 45226

CHAPTER 2

SITE PREPARATION AND INSTALLATION

This chapter provides instructions for design and preparation of the checkstand for scanner or scanner-scale installation. It also specifies physical parameters, power and ventilation considerations, cable routing information and unit installation for different models.

There are three basic steps:

1. [SECTION I. Pre-Installation Considerations, below](#)
2. [SECTION II. Checkstand Preparation, starting on page 24](#)
3. [SECTION III. Installation, starting on page 30](#)

Once the procedures in this chapter are complete, the scanner is ready for operation. If a scanner-scale was installed, calibration will be required before placing the unit into operation. You must consult the local weights and measures authority to ensure that all legal requirements are met concerning calibration and certification. See "[Calibration Procedures](#)" starting on page 65 for detailed procedures for calibrating the scale in either pounds or kilograms.

SECTION I. PRE-INSTALLATION CONSIDERATIONS

This manual does not cover all factors relating to worker safety and checkstand design. It does, however, offer a list of considerations that may be helpful in ensuring greater safety and productivity. Careful planning using these general guidelines should result in a more efficient, comfortable work environment.

The U.S. Bureau of Labor Statistics reports that the incidence of repetitive motion injuries has increased dramatically in recent years. Checkstand design and scanner installation and operation procedures can reduce the risk of repetitive motion injuries, but not eliminate it.

Although there are currently no formal guidelines for checkstand ergonomics, the Food Marketing Institute (FMI), Occupational Safety and Health Administration (OSHA) and the National Institute of Occupational Safety (NIOSH) of the Department of Health and Human Services have released the reports listed at the end of these recommendations. These reports contain suggestions for ergonomic improvement of checkstand designs and scanner installation, maintenance and usage. Portions of the reports are summarized below. For copies of the complete reports, or to inquire about any modifications to the recommendations, contact FMI, OSHA and NIOSH at the addresses listed in "[References](#)" on page 12.

Ergonomic Recommendations

1. Select a design which allows load-sharing by several muscle groups (for example designs which allow the cashier to use both hands for scanning and bagging).
2. Use a powered in-feed conveyor to help cashiers bring the items to their best work zone, rather than leaning and reaching to get items further up the conveyor.
3. Select checkstands which deliver products to the cashier on an input belt and do not require the unloading of items from a cart. These designs put less stress on the cashiers' shoulders and back.
4. Minimize the distance between the input and take-away conveyors (i.e., the distance the cashier has to reach to move the products).
5. Minimize the width of the input conveyor to reduce the cashier's reach to items on the far side of the belt; use a diverter or "sweeper" to direct products closer to the cashier.
6. Select a design which encourages the cashier to slide products across the scanner rather than gripping and lifting. Make sure the horizontal surface of the scanner is flush with all surrounding surfaces.
7. Choose a design which integrates the scanner and scale to eliminate extended reaches and lifts during weighing tasks.
8. Place the conveyor belt electronic eye close to the scanner, but allow sufficient area between the eye to ensure the belt does not push items in to the scanning field.
9. Locate commonly used items such as the cash drawer and printer within easy horizontal reach.
10. Remove, round-off, or pad sharp or hard edges with which the cashier may come into contact.
11. Provide an easily accessible bag stand at a height of 33 - 43.2 cm (13 - 17") lower than the top surface of the checkstand to reduce stresses to the shoulders, elbows, and risks associated with lifting products into bags.
12. Do not position the bag stand between the cashier and the scanner, due to the increased reach involved.
13. Position the scanner's horizontal scanning surface 86.4 - 91.4 cm (34 - 36") above the floor. Maintain a minimum of 12.7 cm (5") clearance between elbows and work surfaces.
14. Provide adjustable keyboard mounting (height, tilt, and horizontal reach).
15. Position the printer, cash drawer, and other checkstand devices the cashier uses within easy reach (less than 46 cm/18").
16. Provide adequate toe space (at least four inches), foot rests or rails, antifatigue mats, and where feasible, an adjustable seat or stand against which the cashiers can lean.

Checkstand Design

Counter Preparation

Since the majority of grocery checkout lanes are designed as “left-hand take away,” the counter drawings in this section focus on this counter design. Simply reverse the layout for a “right-hand take away” requirement. The unit scans equally well in either configuration.

The most important consideration when planning the counter opening for the scanner is the operator’s comfortable reaching distance. The ideal, ergonomically sound installation allows items to be directed within easy reach, and a scanning area requiring no lifting or special orientation of items. If you haven’t already read the information at the beginning of this section titled, , please do so before continuing these instructions.

The symmetrical design of the scanner permits the operator to easily pass items from one hand to the other while scanning (either from right-to-left or left-to-right). With the unique multi-side scan zone, scanning is accomplished in one fluid motion. The operator simply slides the item from the conveyor belt or diverter area through the scanning area and passes the item to the other hand, which in turn bags it or places it on a take-away conveyor belt. Movement should flow naturally over the surface of the scanner.

Figure 1 shows a typical “left-hand-take-away” checkstand design.

Figure 1. Typical Checkstand Design

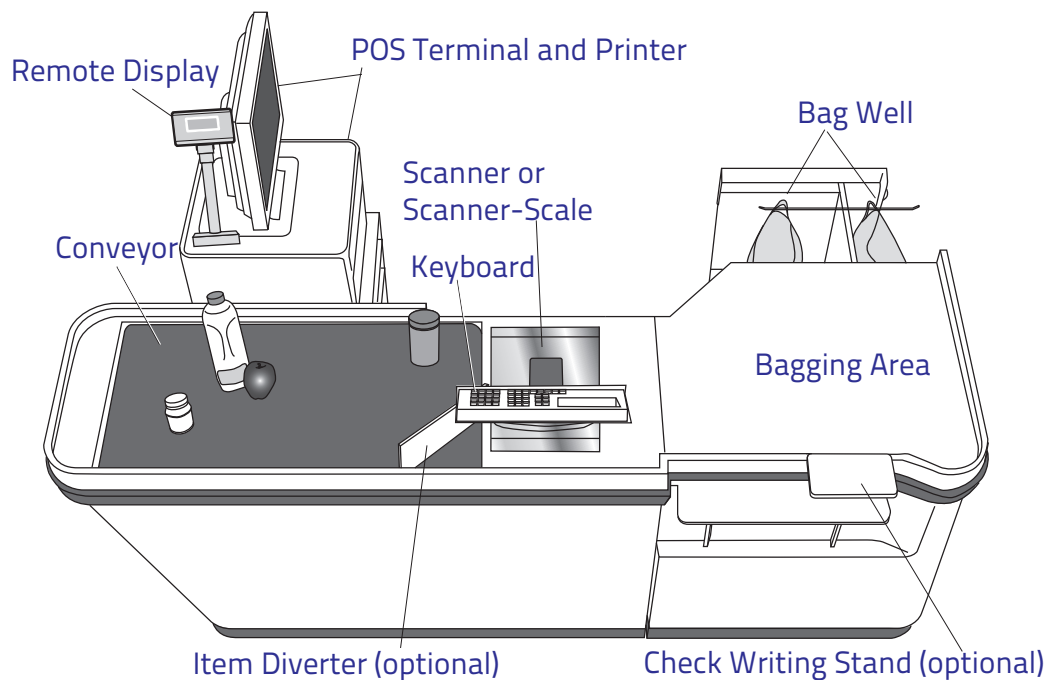

Site Requirements

Consider the following factors before installing the scanner/scanner-scale and its optional Remote Scale Display.

Ventilation Requirements

The scanner operates without the use of a ventilation fan. As long as there is adequate convective air flow and no major heat producing equipment in close proximity, the unit's housing provides adequate heat dissipation. The air temperature in the checkstand around the scanner must not exceed 104°F (40°C).

The scanner-scale's perimeter housing has been designed to provide adequate space for convective cooling and unrestricted movement of the weighing apparatus. Figure 2 shows the debris chutes and ventilation slots. The checkstand design must:

- keep the ambient air temperature inside the checkstand adjacent to the scanner below 104°F (40°C).
- allow a source of air that provides adequate cooling by convective air flow.



NOTE: DO NOT place the scanner in a close-fitting, fully enclosed checkstand. Provide a MINIMUM of 103.2 cm² of air intake from below the installation for sufficient convective cooling.

If motors, conveyor belts, or other heat-producing equipment are located near the scanner, forced air ventilation may be required. In most installations, a 30 cfm (51m³/h) axial fan should provide sufficient air movement. If a ventilation fan is installed, it is recommended to use one with a removable filter that may be washed or replaced.

Figure 2. Debris Chutes & Ventilation Slots

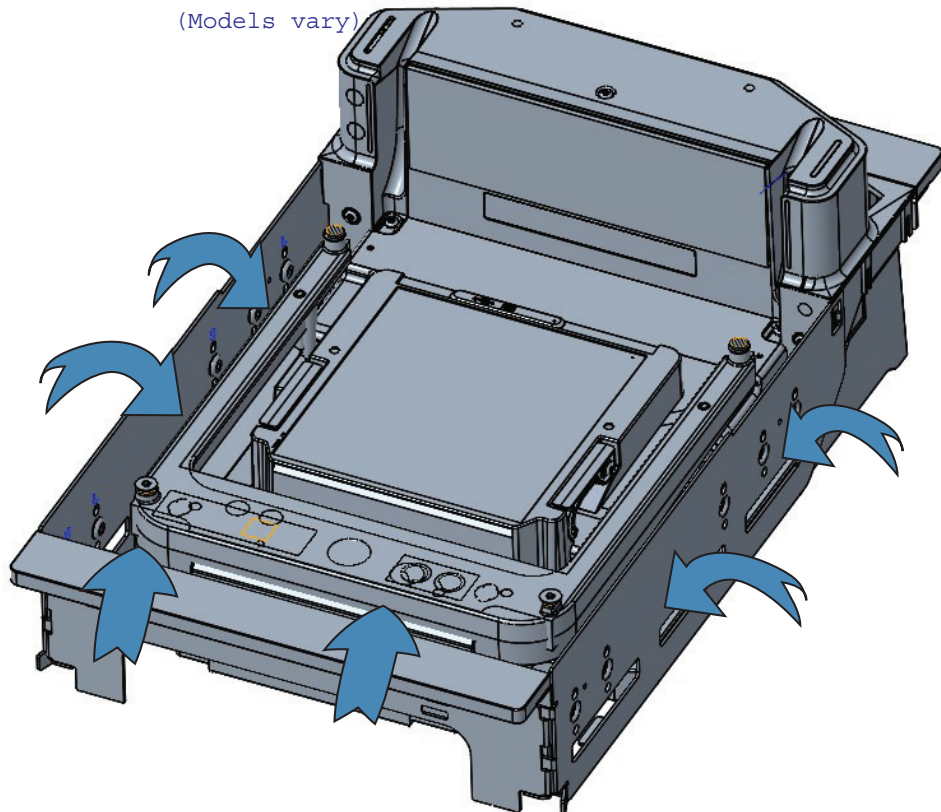

Service Access Requirements

The scanner and scanner-scale have been engineered to allow performance of all routine service and maintenance (such as “zeroing” and calibration) without removing the scanner from the checkstand. Additionally all cable connections made at the scanner can be connected and removed while the unit is sitting on the countertop. The installer should provide service access to all remaining cable connectors as well as the AC/DC Power Supply (if installed).

Recommended Power Installation

Since the typical grocery environment includes conveyor belts and electric motors, care should be taken to ensure that the scanner has a supply of “clean” power (power without excessive electrical noise).

Liquid Drainage

Select a checkstand design which allows fluids to flow through, and directs liquids away from any electronic equipment or storage areas.

Should a liquid spill occur, ensure that moisture can flow through the checkstand without pooling.

Leveling

Both flange mount and shelf mount scanners may require leveling during installation to ensure the platter is flush with the counter. Each type is leveled using different methods:

- Shelf mounted scanners use built-in leveling screws that mount to the support rail and can be adjusted as needed. These adjustable leveling screws are adjusted from the top of the scanner with a slotted screw driver, with the platter removed. They should be adjusted so the platter is flush with the top of the counter.
- For a flange mount scanner, adjustment screws must be provided by the user if leveling is required. The leveling screws should be installed where shown on the counter cutout/ installation page (see [Counter Cutout, starting on page 24](#)). Similarly to the shelf mount scanner, the flange mount scanner platter should be adjusted level to the top of the counter.

Cable Routing

Placement of the scanner-scale should be planned to allow easy access to other components, as well as optimize communication between the scanner, the POS terminal and the optional Remote Scale Display. Note that cables may drop straight down from the scanner’s connector panel, or may be routed along the unit’s side using the hardware provided. Do not route interface cables near any electrical motors or other sources of electromagnetic interference.

Remote Scale Display Placement

The customer, and checker in some instances, must be able to easily view and read the Remote Scale Display (if one is present). Ambient light and mounting height considerations are discussed later in this section.

Vertical Clearance

A minimum vertical clearance of 3.8 cm (1.5") MUST be provided (reference Figure 3). This will facilitate ease of scanning, and allow adequate space above the scanner bonnet for removal and replacement of the All Weighs™ Platter (the L-shaped platter).

Figure 3. Vertical Clearance

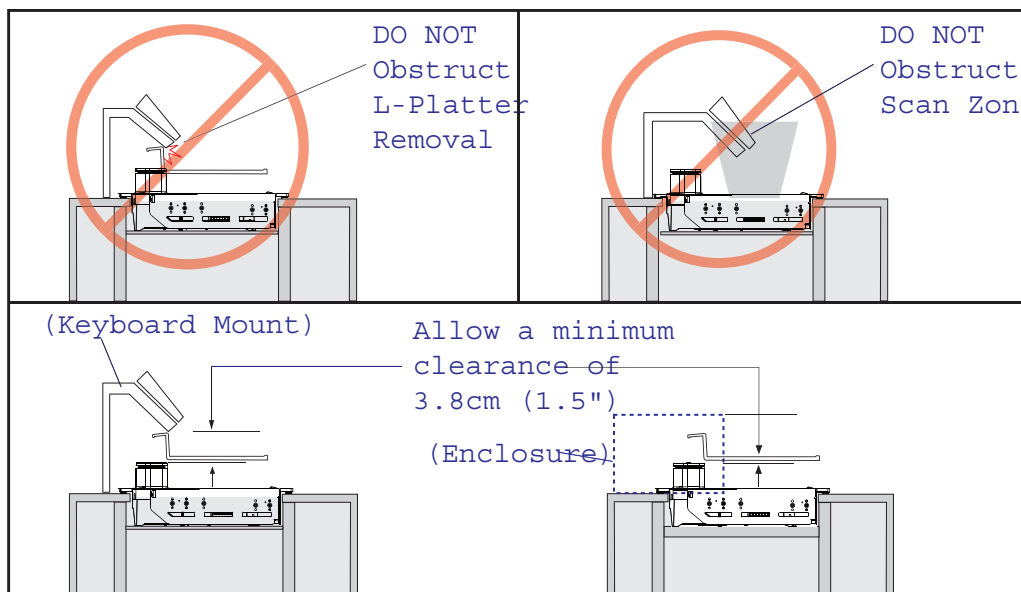

Display Clearance

Clearance must be allowed so that a POS display will not interfere with the scanner's read zones.

POS display placement must not encroach the scan zone formed by the horizontal and vertical windows. The bottom of the display must be no lower than the 30° line shown in , which projects from the front edge of the bonnet, 6 cm above the weigh platter.

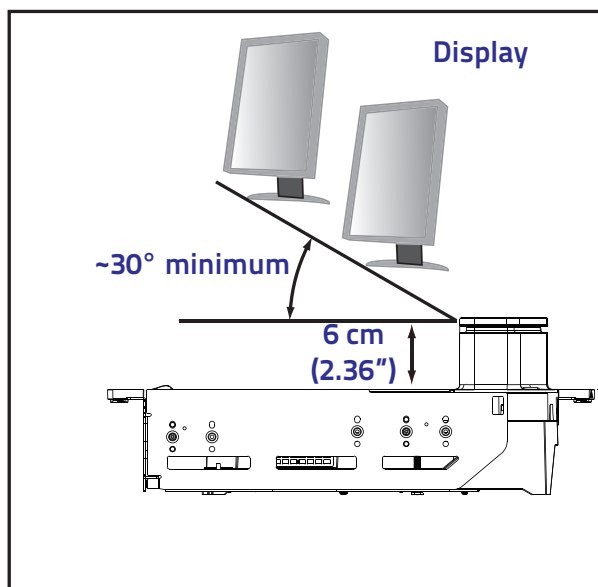

Scanner Weights

When selecting materials and designing supports for scanner installation, don't forget to factor in the weight of the scanner or scanner-scale and the products that will need to be weighed or scanned during checkout.

Model	Description	Weight
Magellan 99222xxx Magellan 99225xxx Magellan 99227xxx	Long Scale - Flange	8.2 kg (18 lb)
Magellan 99122xxx Magellan 99125xxx Magellan 99127xxx	Long Scanner only - Flange	7.0 kg (15.5 lb)
Magellan 99221xxx Magellan 99223xxx Magellan 99226xxx	Long Scale - Shelf	7.9 kg (17.3 lb)
Magellan 99121xxx Magellan 99123xxx Magellan 99126xxx	Long Scanner only - Shelf	6.7 kg (14.8 lb)
Magellan 99212xxx Magellan 99215xxx Magellan 99217xxx	Medium Scale - Flange	8.0 kg (17.7 lb)
Magellan 99112xxx Magellan 99115xxx Magellan 99117xxx	Medium Scanner only - Flange	6.9 kg (15.2 lb)
Magellan 99211xxx Magellan 99213xxx Magellan 99216xxx	Medium Scale - Shelf	7.7 kg (17 lb)
Magellan 99111xxx Magellan 99113xxx Magellan 99116xxx	Medium Scanner only - Shelf	6.6 kg (14.5 lb)
Magellan 99101xxx Magellan 99103xxx Magellan 99106xxx	Short Scanner only - Shelf	6.4 kg (14.1 lb)

Flange Mount vs. Shelf Mount

Flange mount scanners and scanner-scales are supported in the counter by brackets built into the front and back of the scanner. The flange brackets rest in a recessed pocket in the countertop and the scanner is suspended between them.

Shelf mount scanners and scanner-scales are supported by means of a shelf directly under the body of the scanner.

See the figure below for easy identification of flange and shelf mount scanners.

Figure 4. Flange Mount vs. Shelf Mount

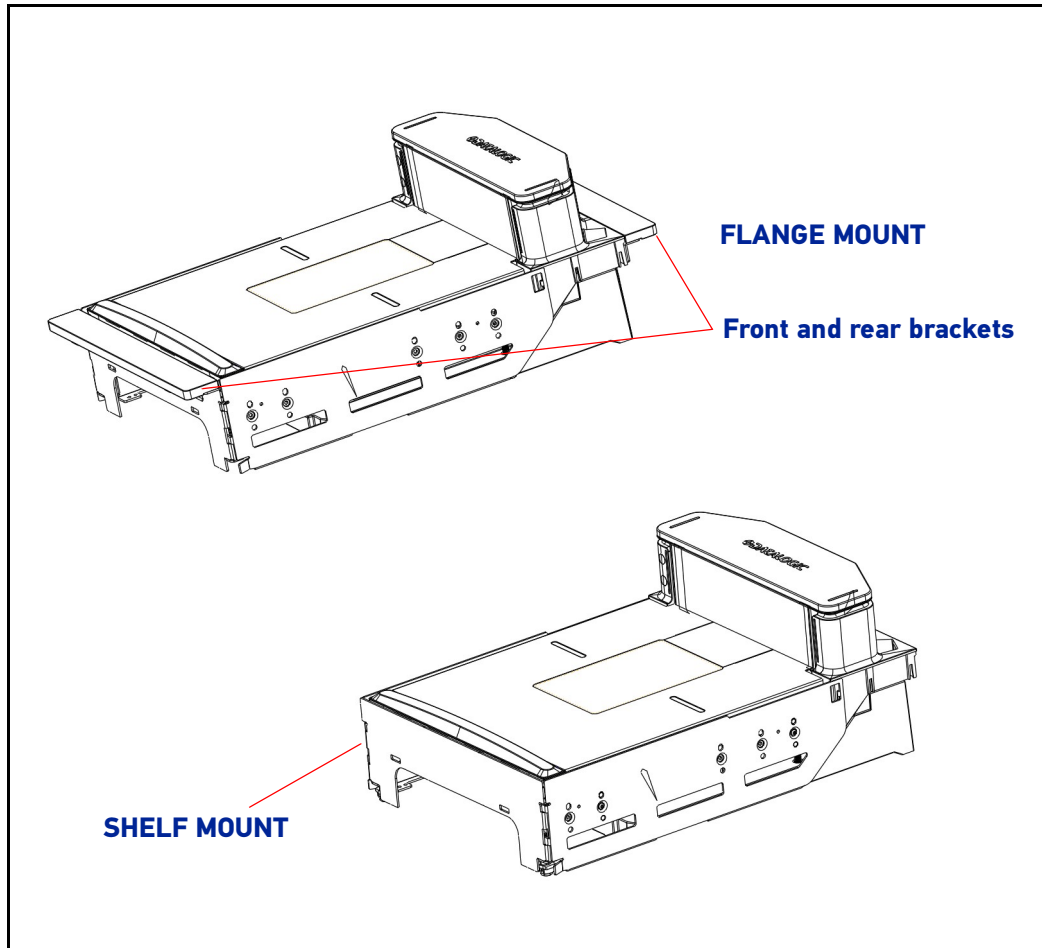

Scanner Dimensions



NOTE: For reference only - see "Counter Cutout" on page 24 for actual counter cutout dimensions for your model.

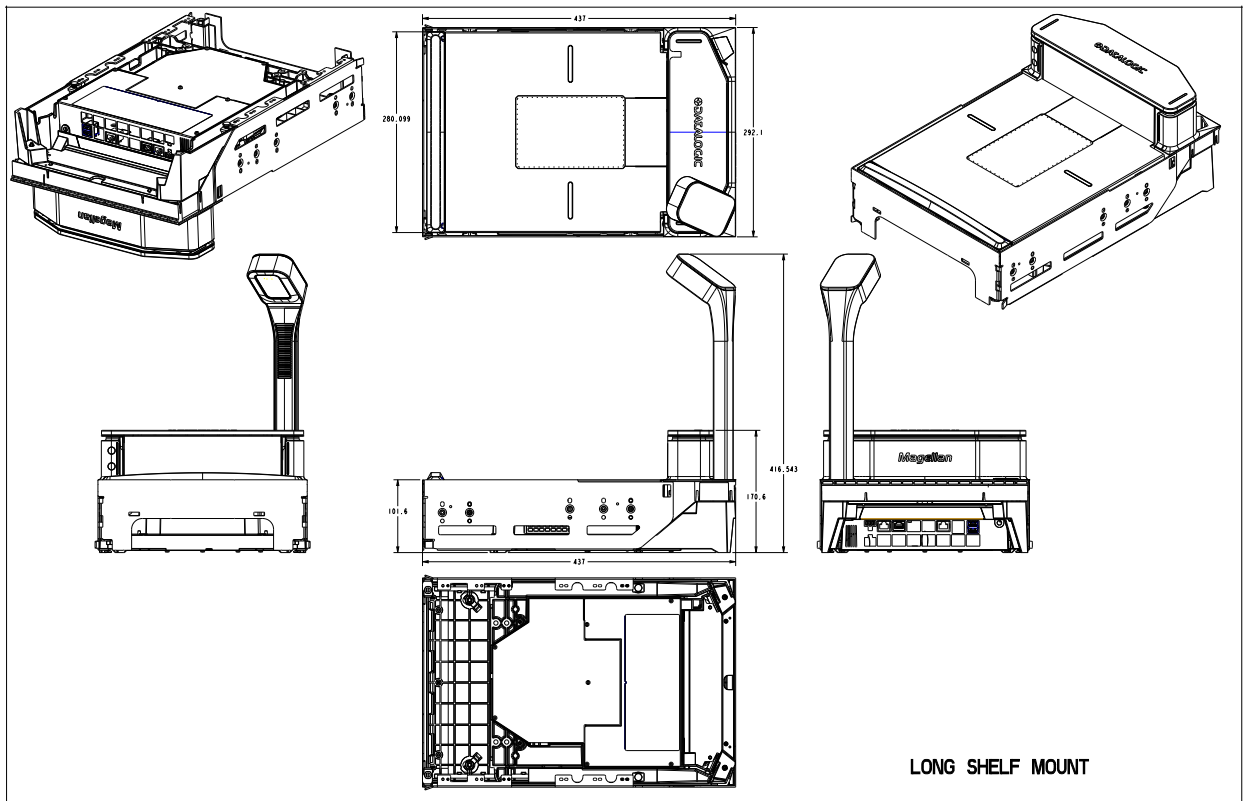
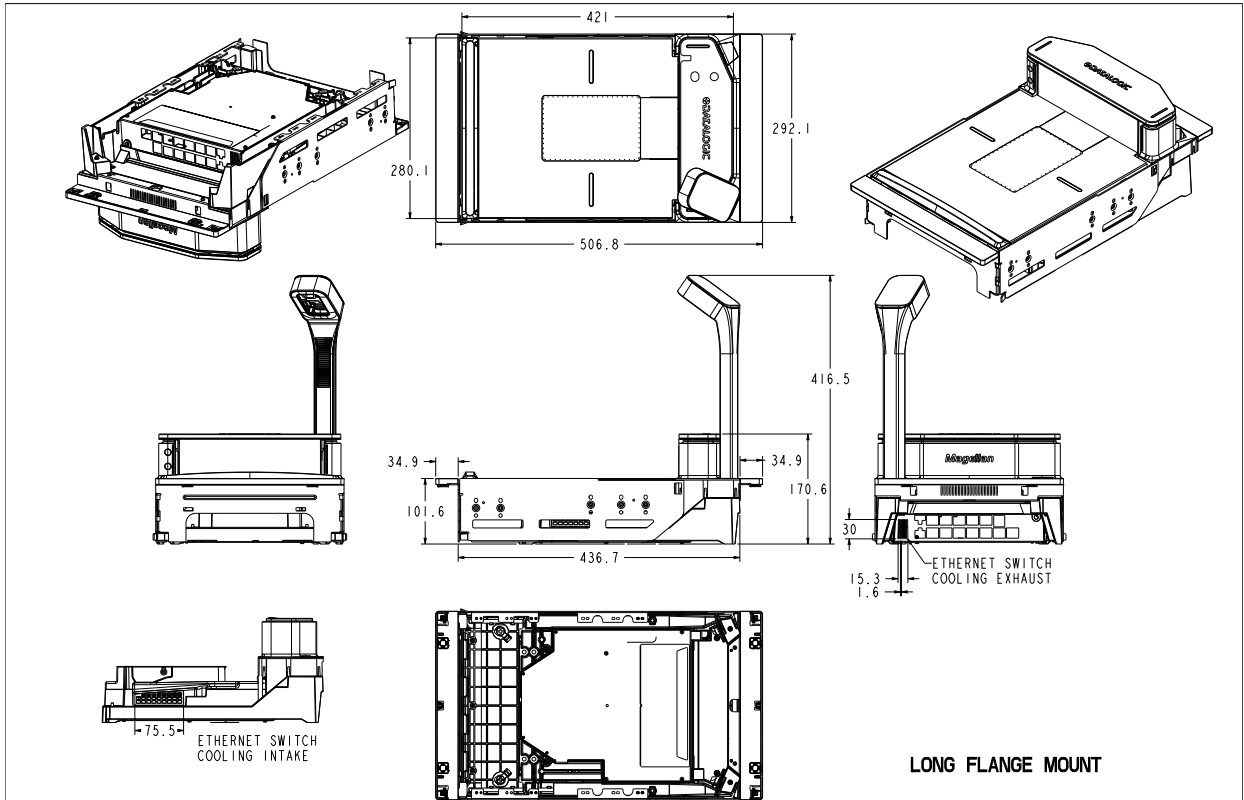

FOR REFERENCE ONLY

Scanner Dimensions (continued)



NOTE: For reference only - see "Counter Cutout" on page 24 for actual counter cutout dimensions for your model.

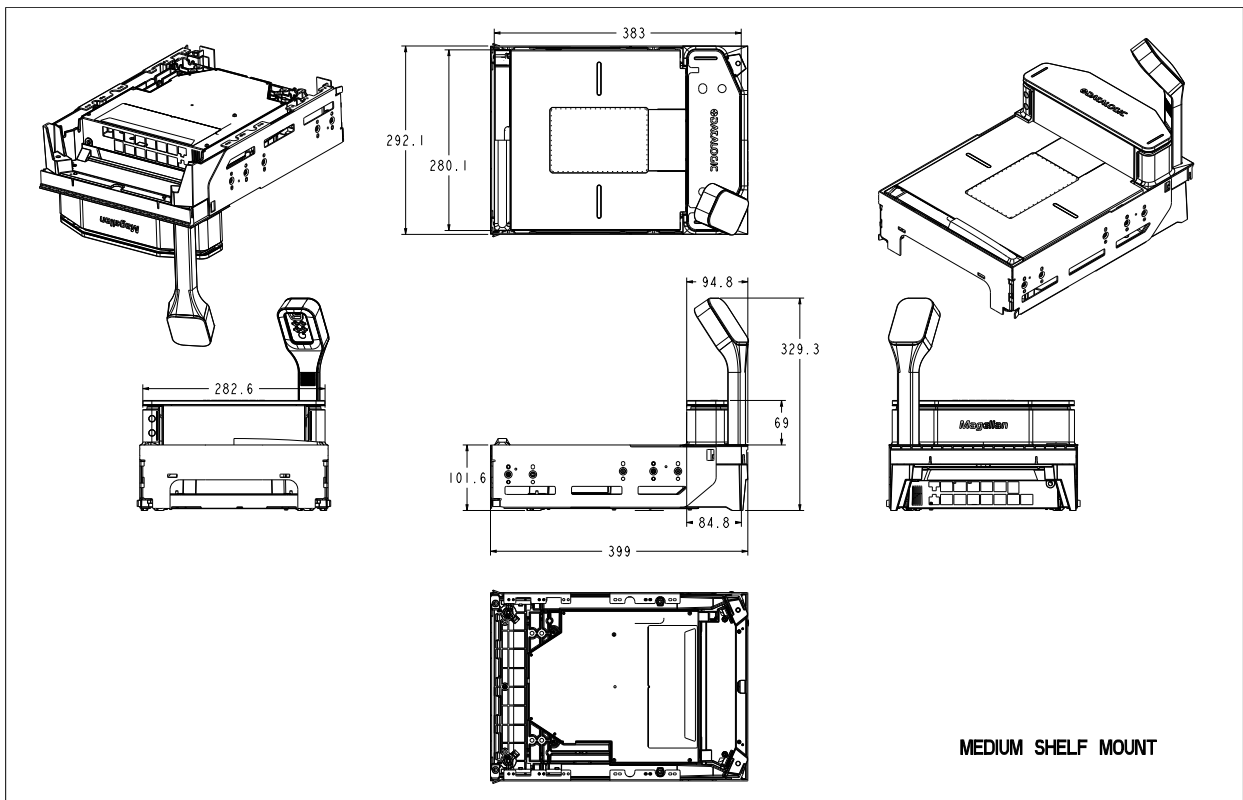
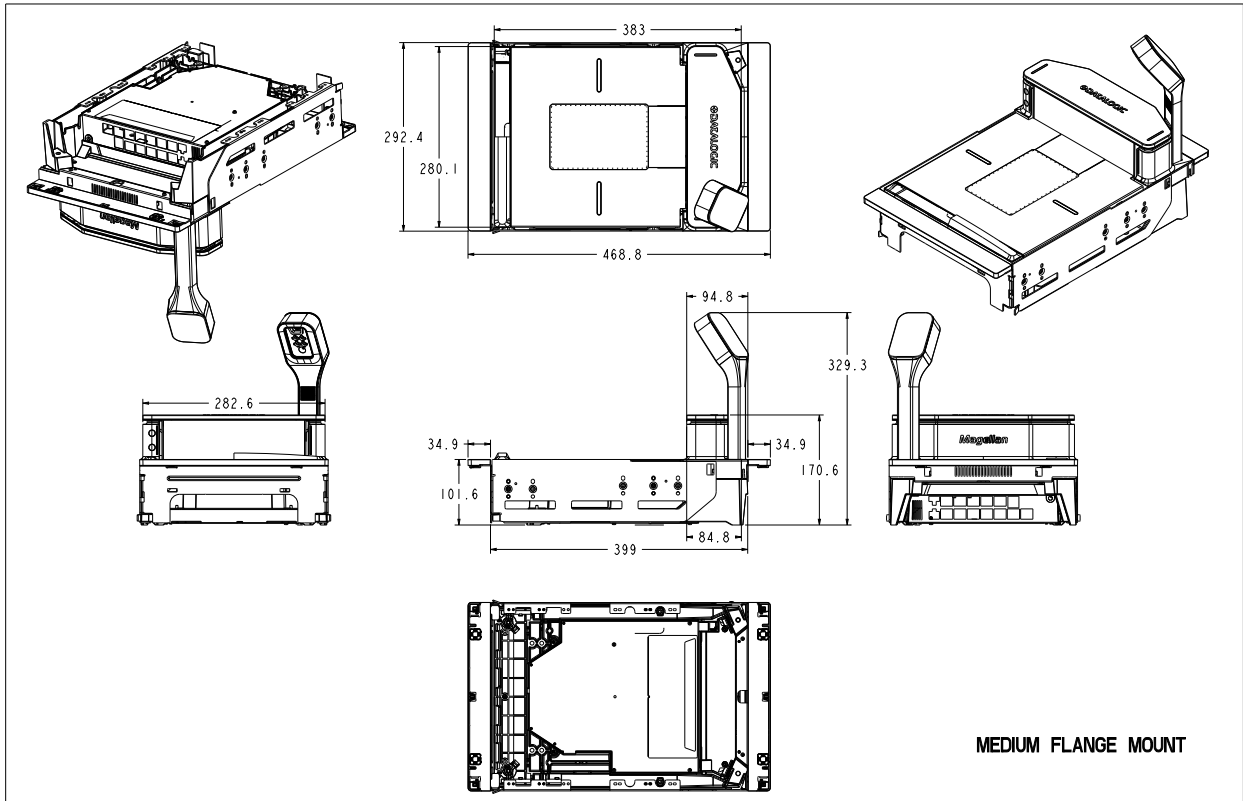

FOR REFERENCE ONLY

Scanner Dimensions (continued)



NOTE: For reference only - see "Counter Cutout" on page 24 for actual counter cutout dimensions for your model.

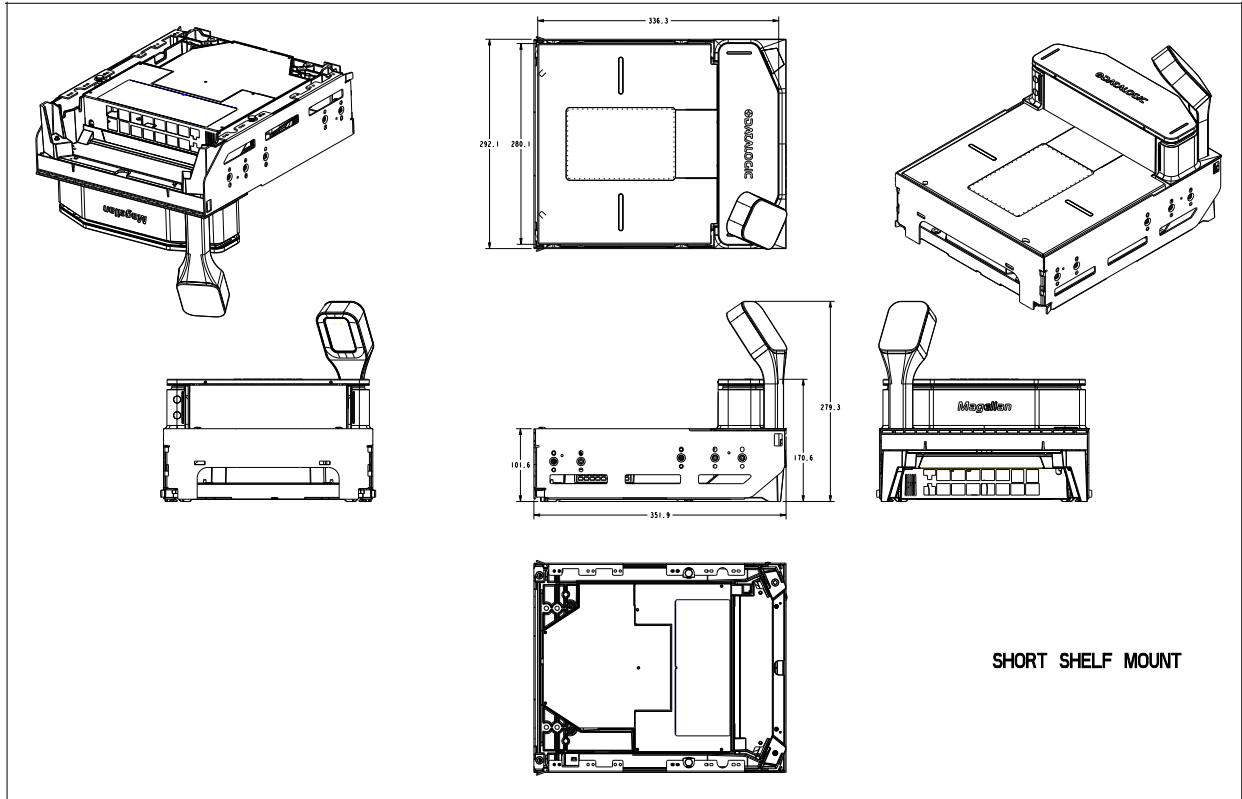

FOR REFERENCE ONLY

SECTION II. CHECKSTAND PREPARATION

When performing a first-time installation into a new checkstand, verify before cutting that room will be allowed for cabling and the AC/DC Power Supply. When making the opening, take extra care to accurately cut to the correct dimensions. Mounting may require installation of support(s), countertop routing, or other such devices. Depending upon checkstand design, you may wish to install an item diverter to direct items toward the scan window. See “Counter Cutout” below for more details concerning the location and preparation of the opening.

Most models are designed to fit with little or no modification into openings cut for previously installed scanners such as other Magellan™ scanners, or NCR® scanner models 7874/5/6/7/8.

Counter Cutout

The following guidelines for preparing an existing checkstand to accept a scanner or incorporating the unit into a new checkstand design will not be accurate for all installations. Although these guidelines will suffice for most standard installations, the installer may need to make adjustments to accommodate varying counter heights and thicknesses, support design, or other checkstand limitations.

See “SECTION I. Pre-Installation Considerations” starting on page 13 for more information about checkstand design.

Figure 5. Installation Overview

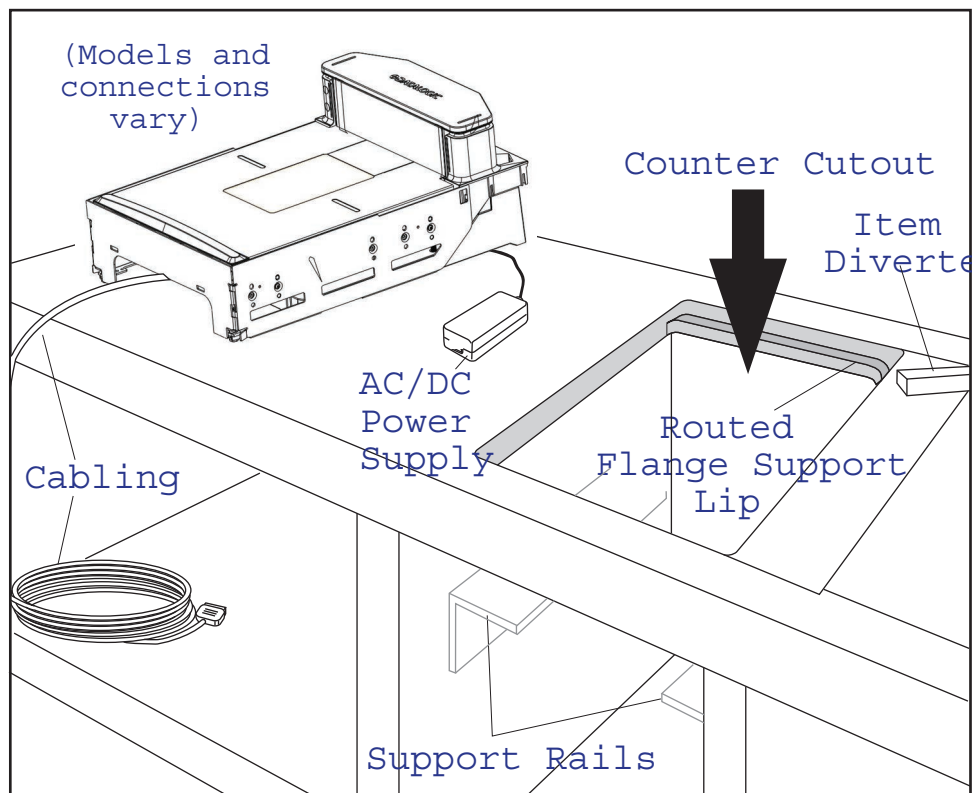

Follow these basic steps to prepare the counter for the unit:

1. Select a position for the scanner that offers a smooth product flow which best accommodates the reaching distance of the average operator.
2. Cut the opening in the countertop. Select the appropriate drawing for your model.

Figure 6. Counter Cutout and Scanner Support Dimensions - Short

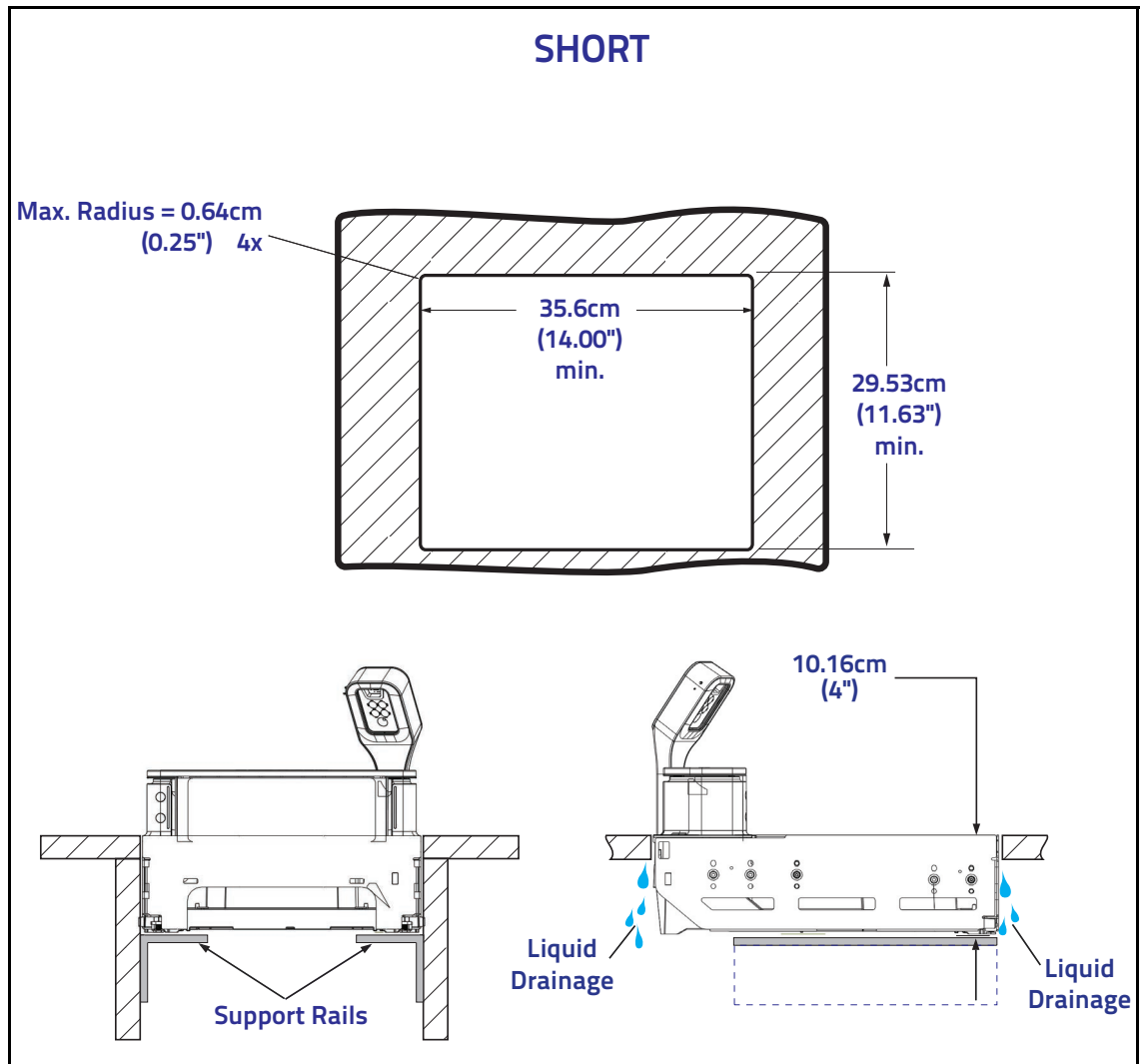

Figure 7. Counter Cutout and Scanner Support Dimensions - Medium (Shelf Mount)

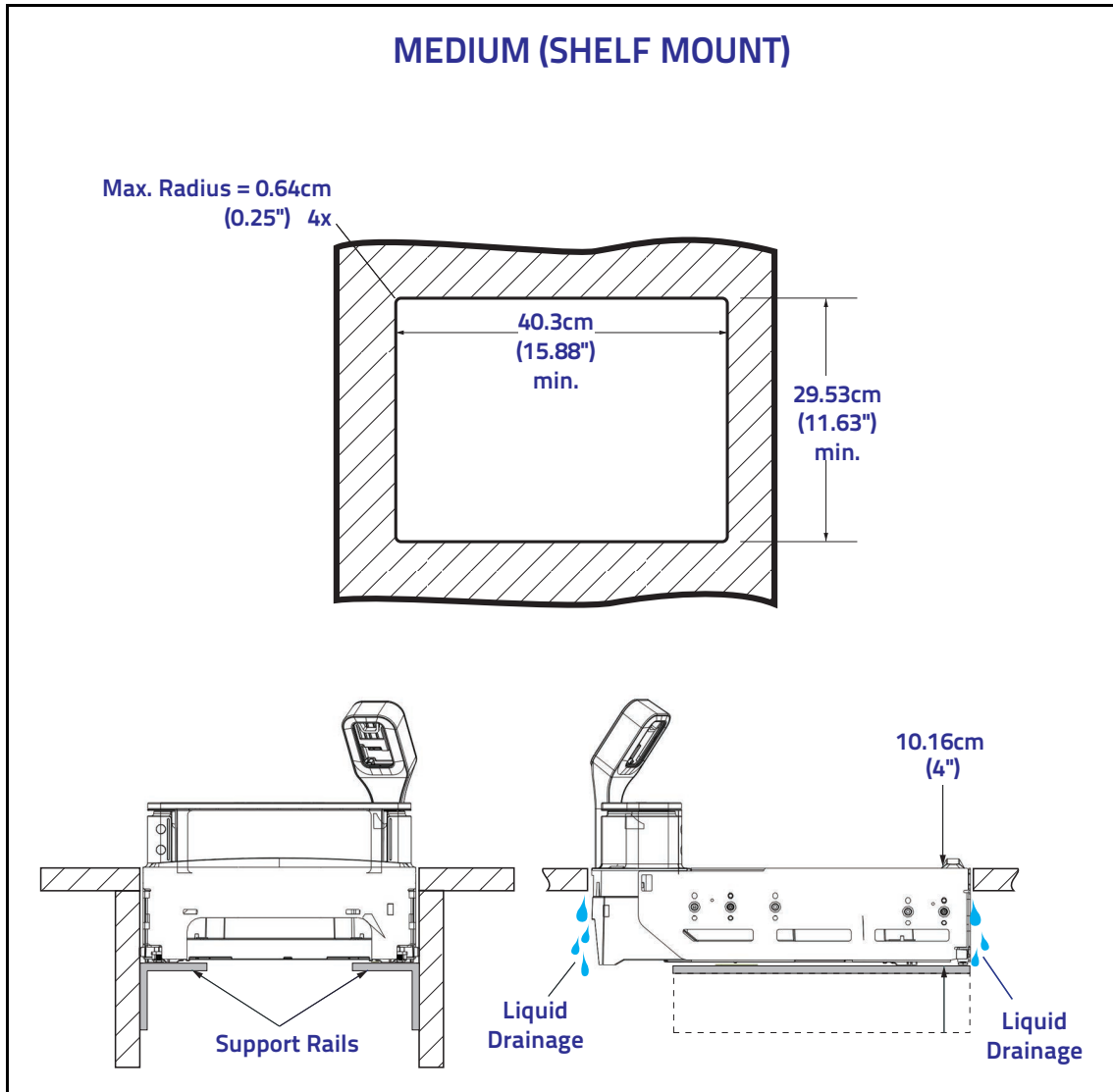

Figure 8. Counter Cutout and Scanner Support Dimensions - Medium (Flange Mount)

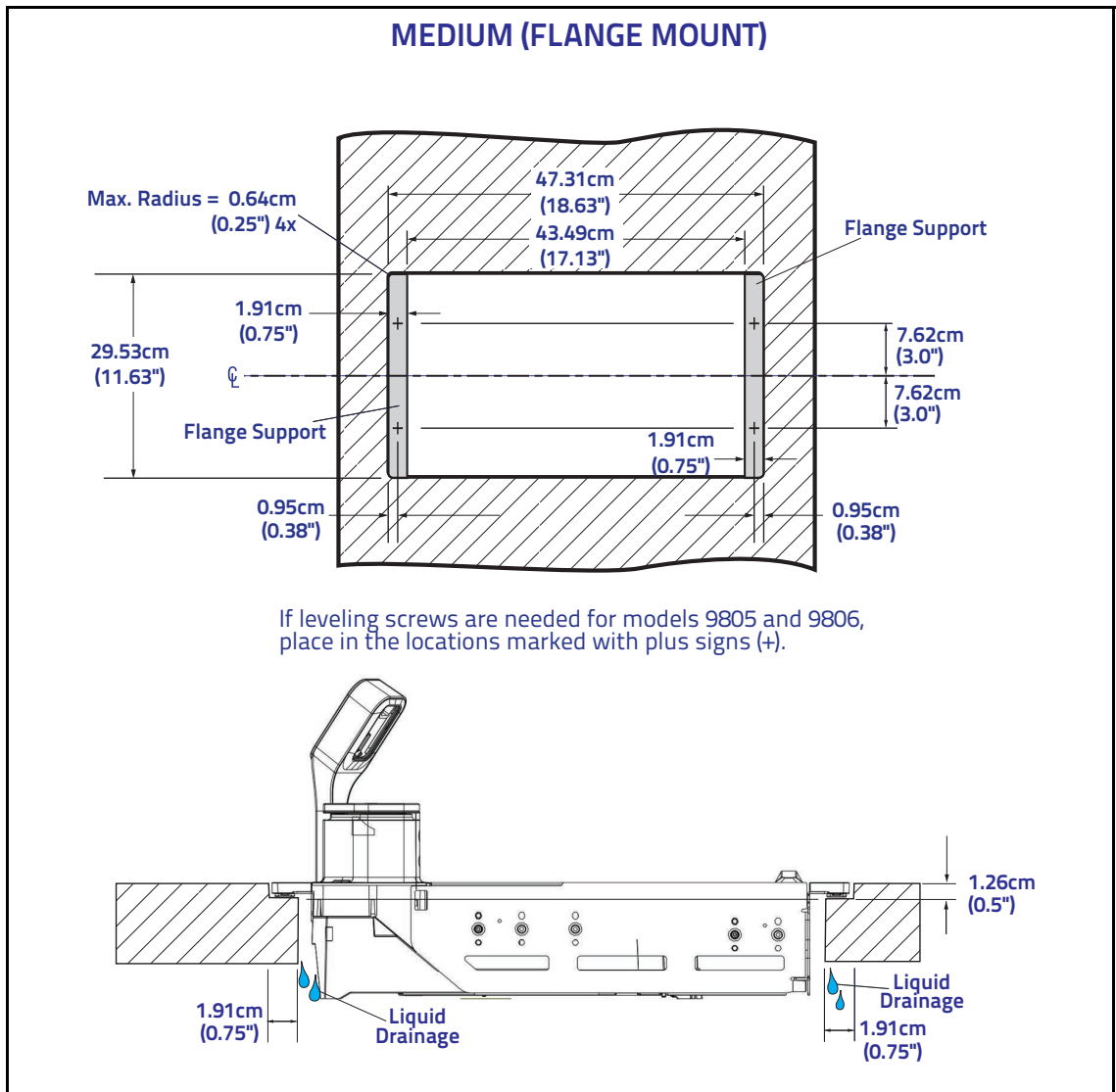

Figure 9. Counter Cutout and Scanner Support Dimensions - Long (Shelf Mount)

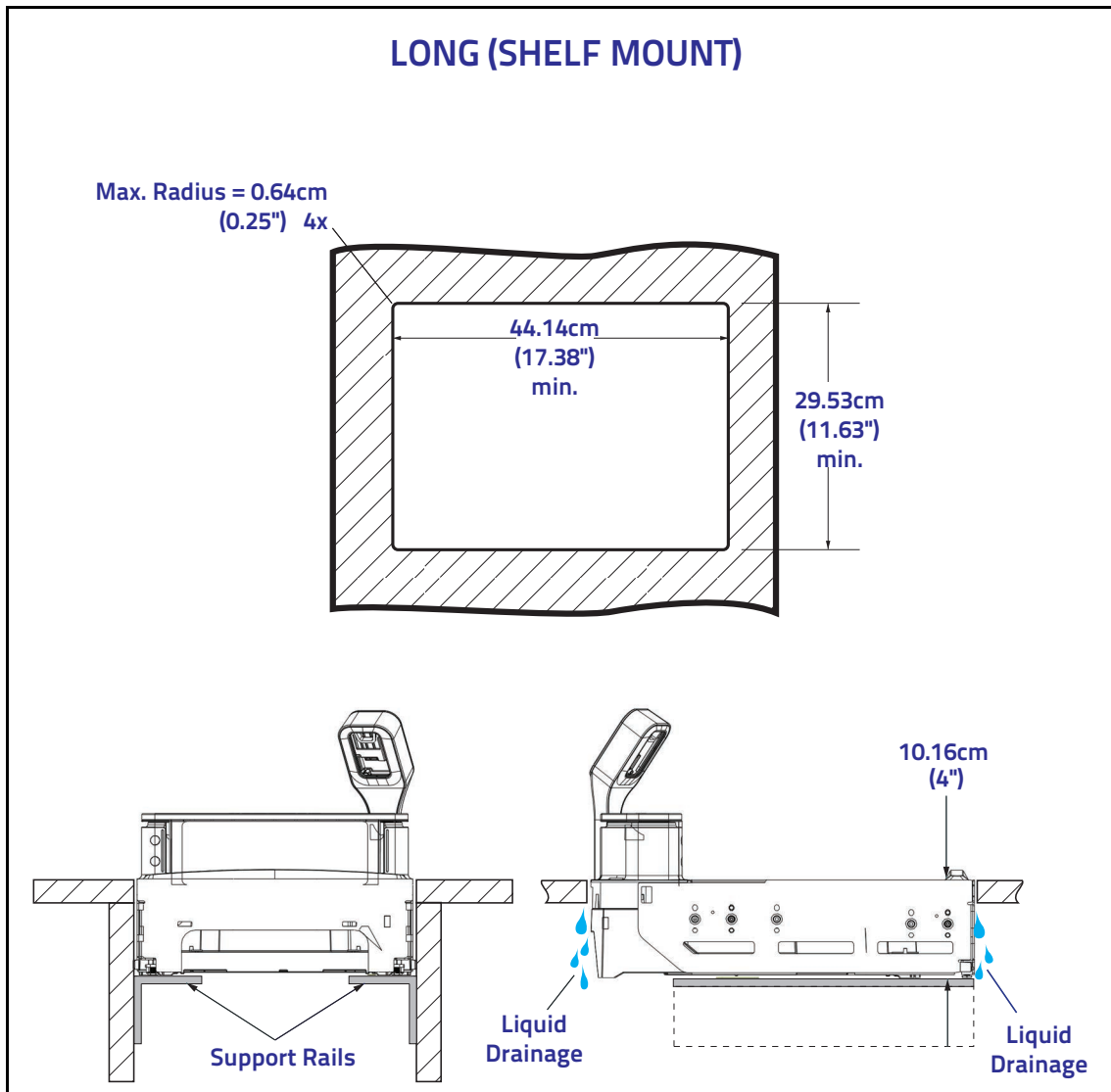
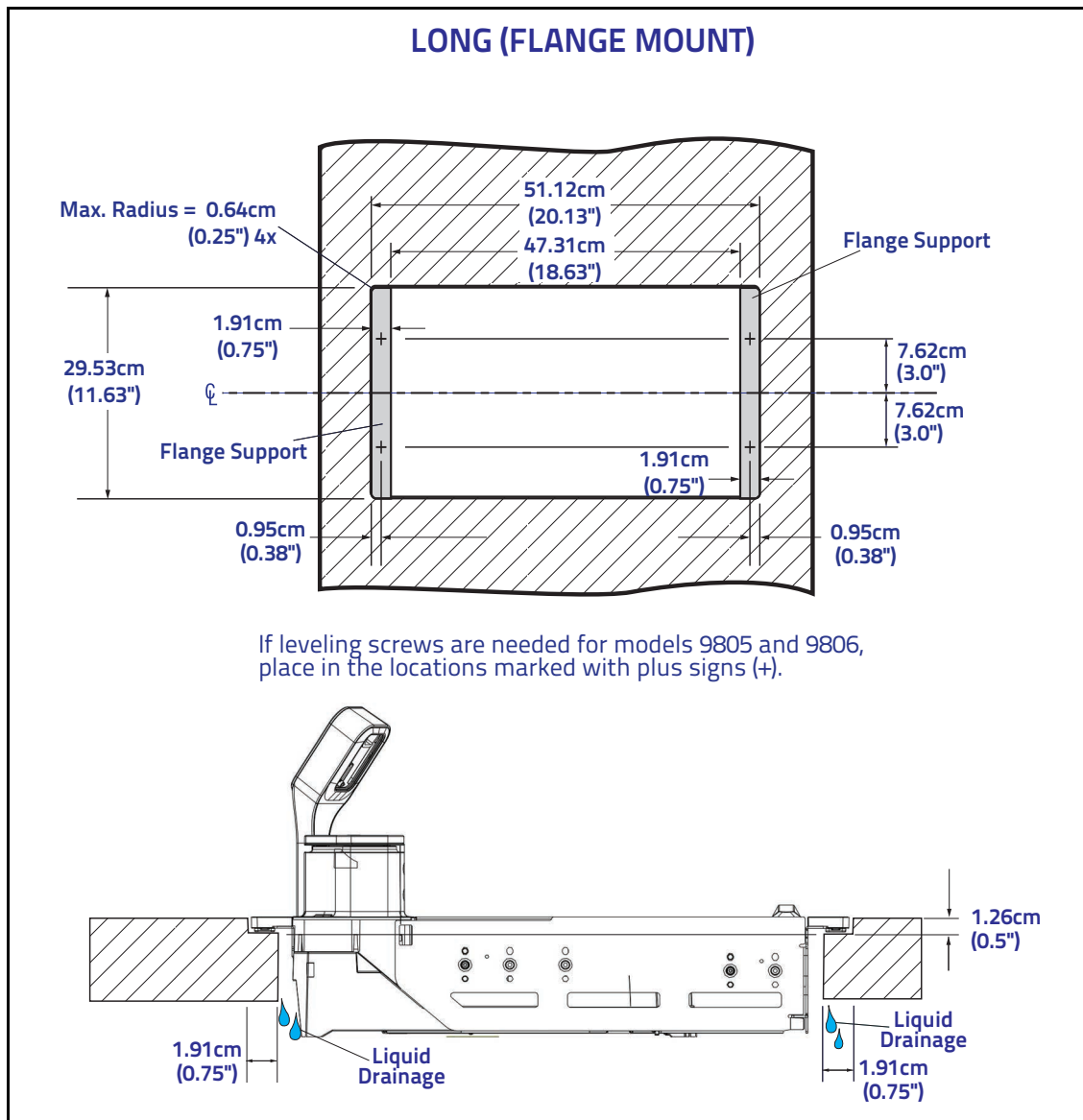

Figure 10. Counter Cutout and Scanner Support Dimensions - Long (Flange Mount)



NOTE: If you plan to use a router on a countertop with a thickness of 1.9 cm (0.75") plywood, you'll need to add a backing strip that supports the area routed out for the support flanges (see Figure 5). This support strip should minimally be made of 1.9 cm (0.75") thick plywood and be approximately 10.2 cm (4.0") wide and 35.6 cm (14.0") long. This strip should be glued as well as screwed to the underside of the countertop.

3. Drill any holes required to install the AC/DC Power Supply, the Remote Scale Display cable and the interface cable(s) observing the following:
 - Interface cables (and display cable, if applicable) should be routed away from all highly inductive electrical devices, like motors and conveyor belts, and even away from the unit's power cable if possible. See also "Recommended Power Installation" on page 17.
 - Cables should be easy to remove in the event that replacement is required. A little planning now will save a lot of frustration later. See also "Service Access Requirements" on page 17.

SECTION III. INSTALLATION

Overview

The preceding [Site Requirements](#) dealt with installed location and counter preparations to accommodate the scanner or scanner-scale. Having completed those steps, physical installation of the scanner or scanner-scale can begin. The following instructions apply to all models.

These setup and installation procedures assume that you have already prepared your checkstand to receive the scanner or scanner-scale. If you have not already made the counter cutout, do so now as described in the previous instructions. If your checkstand has been prepared, proceed as follows:

1. Unpack the unit.
2. Route and connect cables.
3. Power up and operation verification.
4. Connect to POS system, re-test to verify operation when connected to the POS system.
5. Install unit in counter.

1.Unpacking

To unpack the unit:

- Inspect the package for signs of damage that may have occurred during shipping. If damage is found, report it to your carrier immediately.
- Lift out the accessory box containing the AC/DC Power Supply, optional Remote Scale Display and cable (if present), and the Quick Reference Guide.
- Remove the Quick Reference Guide and familiarize yourself with the unit's controls and features. Leave the guide at the checkstand when the installation is complete.
- Remove the protective packing and carefully lift the unit from the carton. **Be sure to save the box and all packing material. In the event of failure, the unit must be returned to the factory in its original packaging.**
- Carefully lift off the All Weighs™ Platter as shown in Figure 17 and remove the yellow spacer securing the weigh mechanism. Set the platter back in place.



NOTE: For added protection during shipment, the AllWeighs™ Platter is covered with a tight-fitting layer of vinyl. This vinyl layer MUST BE REMOVED before placing the unit into service.



NOTE: If the unit is equipped with a scale, the scale spacer (below the platter) must also be removed prior to use. Removal of the scale spacer is not applicable to Adaptive Scale models.

2. Route & Connect Cables

2.1 Route the Cables

Considerations when routing the power and interface cables for the scanner and scanner-scale are:

- Ensure that cables are not pinched, kinked or pierced.
- Do not route interface cables in close proximity to electrical motors or other sources of electromagnetic interference.
- Cables can drop directly from their connectors on the scanner, or, alternatively, can be routed along the scanner's side to the back (see Figure 11).

Do not plug the AC power cord into the outlet at this time. It is a good practice to always connect the power cable to the scanner first before plugging it into the AC receptacle. Figure 11 illustrates the basic cable routing scheme.

Figure 11. Cable Routing

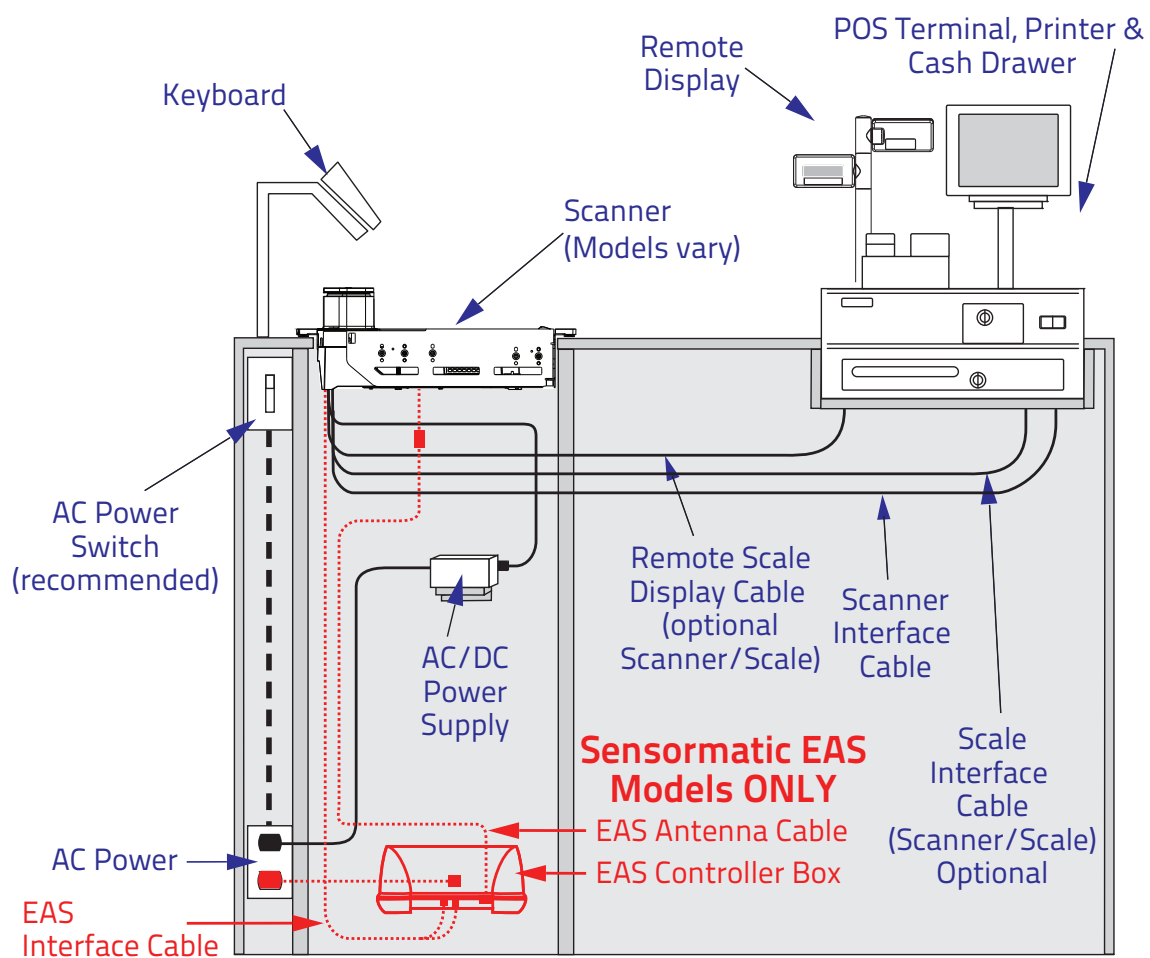

AC/DC Adapter

Figure 12 provides physical dimensions for the AC/DC Adapter (part number 90ACC0078).

Figure 12. Physical Measurements: AC/DC Adapter

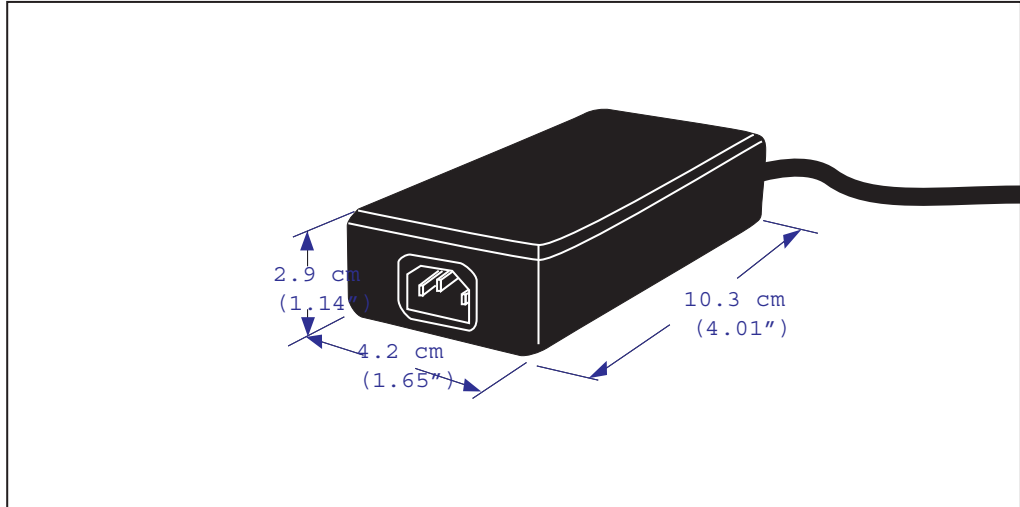

Grounding

The AC/DC Power Supply should have an AC outlet with a clean earth ground. If you are not sure how to verify the amount of electrical noise (interference) on the power line, ask a qualified electrician to measure the input line voltage.

2.2 Connect cables

Follow these steps to ensure that your unit has arrived undamaged and is fully functional before installing it in the counter and connecting it to your POS system.

1. Place the unit on the checkstand next to the counter cutout.
2. Route the cables up through the cutout and connect the scanner and scale interface cable(s), and Remote Scale Display cable (optional) to the scanner. Some POS terminals require two interface cables; one for the scanner interface and one for the scale interface. Refer to Figure 13 for cable connection locations.

If you have a scanner with no scale, there will be only one interface cable to the POS terminal.

3. Connect the power cord to the scanner and route the other end down through the checkstand to the AC power outlet. DO NOT plug the power cord in at this time.
4. OPTIONAL — Route your EAS antenna cable down through the checkstand cutout. (Reference your EAS controller's set-up instructions for proper EAS antenna installation.)



NOTE: Some cables are color-coded to indicate the location to which they should be connected.

Figure 13. Connecting Cables to the Scanner/Scale

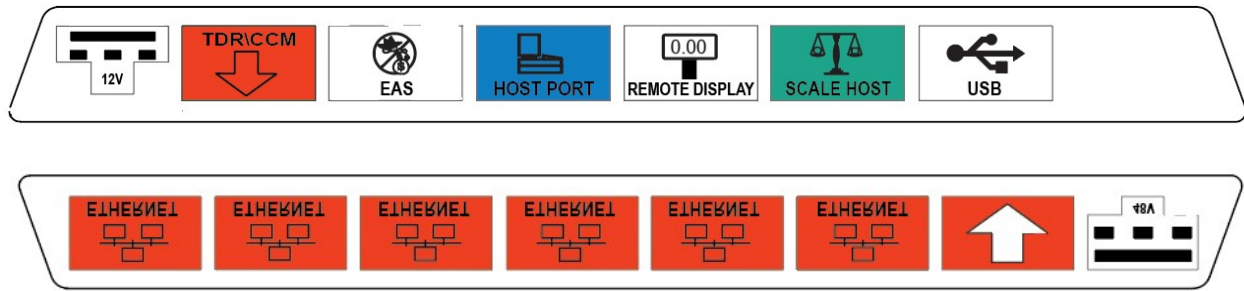

POWER	TDR/CCM*	EAS*	HOST PORT	REMOTE DISPLAY	SCALE HOST	USB PORTS*
AC Brick Input OR Power off Terminal (POT) Brick input	To connect a Top Down Reader or a Color Camera Module	Provides Good Read output to enable EAS antenna RF output	Label Data Scale Data (for single cable interfaces) Application Download	Drives Remote Display (scale models only)	Scale Data (dual cable scanner/scale) Dual cable units only. (Scale connec- tion may be handled through POS Terminal	USB Handheld Scanner Input USB-to-Serial adapter for scale calibra- tion
*Connection to this port is Optional						

Figure 14. Optional EAS Cable Connections

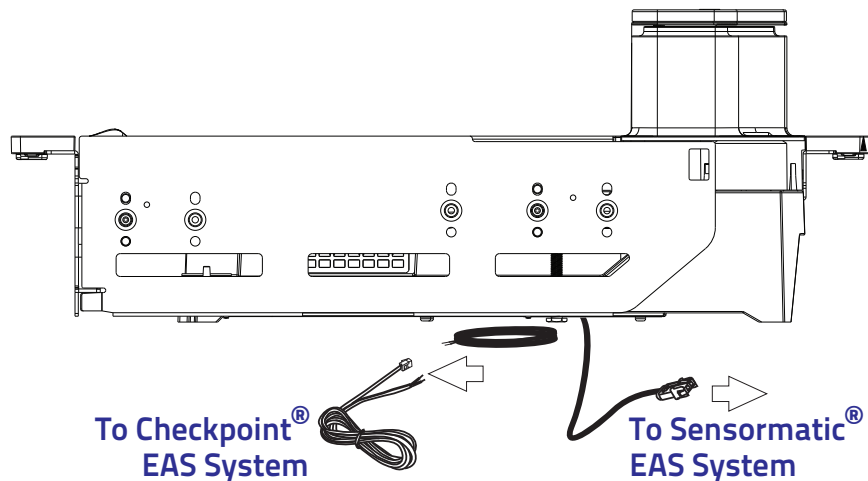

5. Make sure that all cables are firmly attached (except the AC/DC power supply, which should not be connected to the AC outlet yet).

3. Power up & Operational Verification

Connect the power cable first at the scanner, then at the AC outlet.

1. Plug your scanner into an electrical outlet that has been wired to meet all applicable electrical codes, laws, and regulations and has a common ground with the Point-of-Sale terminal.
2. When power is applied to the unit, the normal indicator sequence is:
 - The good read indicator LEDs will be lit (dim) steadily.
 - [EAS models ONLY] The EAS (Ⓢ) indicator LED will flash ON/OFF during power-up.



CAUTION: If the Selftest detects a problem, the Health & Status Indicator will display a number code. Refer to Chapter 4. Problem Isolation, for a description of failure codes and problem isolation procedures.



NOTE: On rare occasions, performance of scale calibration may be necessary to obtain a zero reading on the display.



NOTE: If the Remote Scale Display is not connected, a scanner power-up Selftest will sound a long, low beep, and the characters “= 8 - 9” flashing one digit at a time will appear on the Health & Status Indicator indicating a remote display error. Power down, connect a known-good Remote Display to the appropriate port, and restart to correct this problem. Alternatively, you can disable the Remote Display using programming bar codes (see Chapter 7. Programming, for more information).

Figure 15. Health & Status Indicator

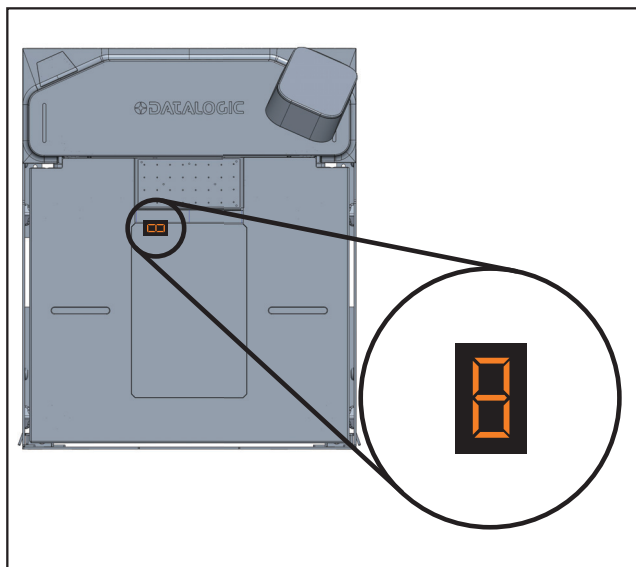



NOTE: The unit should be permitted to reach thermal equilibrium before proceeding to the next steps (see Warm-Up Time). When the unit is moved from a cooler temperature (such as a storage area) to a warmer environment (such as a checkstand location), a period of 60 minutes must be allowed to acclimate the unit to ambient conditions. Once installed and powered up, a “powerup” warm-up period of 15 minutes must occur before calibrating or performing weighing operations. These two warm-up periods may run concurrently.

3. Verify that the scanner or scanner-scale passes an operational test by observing the following:

Scanner: Pass UPC/EAN bar code labels in front of the scanner’s windows. Since the interface cable is not yet connected to the POS terminal, the scanner may be limited to reading only one or two labels (see the note that follows). The scanner indicates when each label has been successfully read by flashing the green scanner light and emitting a good read tone (beep).

EAS System: The way in which EAS tags are deactivated is dependent upon the way the scanner is currently programmed with regard to EAS Mode. (See “EAS Mode” on page 142.) To test EAS system function:

- **Coupled Mode** — Pass an item containing both a bar code and an active EAS tag over the scanner. Successful deactivation is indicated by the bottom-most LED flashing first red, then orange, then returning to green. The beeper will sound a good read beep.
If you have enabled the manual deactivation function available for Coupled Mode (see “Manual EAS Deactivation Push Button” on page -54), test the function by pressing the bottom push button. A ticking sound will be heard which should cease upon deactivating an EAS tag.
- **Decoupled Mode** — In this mode, items do not require a bar code to be scanned to arm the deactivation function. Simply pass an active EAS tag over the scanner in the same direction you would scan a bar code. The bottom-most LED will flash red to indicate deactivation. No beep is sounded to indicate deactivation in this mode.
- **Hybrid Mode** — In Hybrid Mode, the scanner must be enabled, however EAS deactivation in this mode also takes place without needing to scan an item’s bar code. Pass an active EAS tag over the scanner in the same direction you would scan a bar code. The bottom-most LED will flash red, then orange, then return to green. The beeper may be configured to sound a high frequency beep to announce successful deactivation.

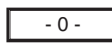
Scale: If the yellow scale indicator LED is not lit, press the Scale Zero  Button momentarily. If the scale is operating correctly, the yellow LED will illuminate and remain on steady, and the display will show a reading of 0.00 lb (0.000 kg for metric). If the display is blank or a  is displayed, it may be necessary to calibrate the scale before continuing. Refer to “Calibrating the Scale (Pounds & Kilograms)” starting on page 68.



NOTE: This function may not apply to Adaptive Scale models.

Remote Scale Display: Verify that 0.00 lb (0.000 kg) is displayed, then place an item on the weighing platter. Verify that the display shows a weight and that the yellow LED goes out. Remove the item and observe that Remote Scale Display shows 0.00 lb (0.000 kg) and that the yellow LED is On.

4. Unplug the AC power cord from the outlet and disconnect the power cord and Remote Scale Display cable from the scanner’s connector panel.

After you have verified that the scanner and scale (if present) are completely functional, continue with the following procedures.

Scale Diagnostic Mode

There is a diagnostic mode available to initiate scale diagnostic tests. Diagnostic messages will be displayed on the Health & Status Indicator.



NOTE: The scanner must be configured to allow Scale Diagnostic Mode. See Programming for details.



NOTE: This function does not apply to Adaptive Scale Models.

To enter Scale Diagnostic Mode, press the Scale Service Button (the same button as ScaleSentry) for approximately four seconds. Six rapid tones will be sounded, indicating the unit is leaving normal operation and entering Scale Diagnostic Mode.

Health & Status Scale Diagnostics

Upon entering Scale Diagnostics, the Health & Status indicator¹ will then sound one medium length beep and display a sequence of characters indicating the following information:

CHARACTERS	EXPLANATION OF INDICATION
c x	Where x is the number of calibrations performed to the scale.
x ≡ x	Where x indicates the number of times the scale has been zeroed.
≡ x	Where x indicates the scale gravity zone.
- xxxx	Where xxxx is the load cell software checksum in hex lower 4 characters.
- x	Where x indicates the scale software revision.
xxxxxxxx	Data area reserved.
zzzz zzzz zzzz	Scale weighing package identifier and signal processing identifier if present.
ucustomdata	Is the value of a custom data string (if present — no data may be displayed if the item value is not set.
The sequence will be repeated	
8	Upon successful completion, the scanner will automatically reset, displaying an 8.

1. The Remote Display (if one is present) can additionally display some scale diagnostic information.

If the diagnostics routine is not completed successfully, the scanner will sound a series of tones and the Health & Status indicator will show an error code. Turn to [Chapter 4, Problem Isolation](#) for a description of error codes.

Press the Scale Zero Button once more to reset the unit and exit Scale Diagnostic Mode. See the topic, [Scanner and Scale Reset](#) in [Chapter 3](#) for more information about unit resets.

Optional Remote Display Scale Diagnostics Indications

If your unit is equipped with an optional Remote Display, it will show the following sequence, with each character being separated by 500ms or greater blank time on the display (for ease of reading). This display continues to scroll across the display for a set number of times.

CHARACTERS	EXPLANATION OF INDICATION
PASS or ERRx	Where x is 1 through 5.
All segments on the display are illuminated.	
▷0◁_x	Where x indicates the number of scale zeroing attempts.
c x	Where xx represents the number of calibrations, with a maximum of 999 displayed.
— x	Where x indicates the scale gravity zone.
xxxx	Where xxxx is the load cell software checksum in hex lower 4 characters.

4. Integration with POS

The System Power-Up procedure may vary depending upon the requirements of your POS system. It is generally a good practice to power down (switch off) all equipment prior to connecting cables. Check with your System Supervisor and/or refer to your POS terminal manual for proper powerdown and powerup procedures and interface requirements when connecting any peripheral device.

If you have not identified any specific requirements for your POS system, follow these steps.

1. Power down the POS terminal.
2. Ensure that power is disconnected from the scanner.
3. Connect the scanner and scale interface cables to your POS terminal. This connection may use one or two cables depending upon your POS terminal interface.
4. Connect the Remote Display cable if your model is a scanner-scale and make any connections to optional equipment, such as EAS¹ or a handheld scanner.
5. Power up the scanner or scanner-scale by connecting the power cord to an AC power outlet. Wait for the unit to complete the Selftest routine (10 seconds maximum).
6. Power up the POS terminal.
7. Verify that both scanning and weighing data are properly communicated between the scanner and your POS system. (Weigh, deactivate² and scan a few items.) If problems are encountered, refer to [Chapter 4, Problem Isolation](#).

1. Some peripheral equipment must be connected or powered on in a specific order. Check the equipment instructions to verify the correct sequence.
2. Test EAS deactivation only if applicable for your model.

5.Scanner In-Counter Installation

These setup and installation procedures assume that you have already prepared your checkstand to receive the scanner or scanner-scale. If you have not already made the counter cutout and routed power and interface cables, do so now as described in the previous instructions.

5.1 Checkstand Mounting

There are a number of things to take into account when installing the unit into a checkstand. Key factors are ergonomic/worker safety, loading capacity and stability. If you have not already done so, refer to "Checkstand Design" starting on page 15.

The scanner will need to be installed so that leading and trailing edges of the All Weighs™ Platter are flush with the countertop to enhance smooth, slide-through scanning. Keep in mind that the debris chutes on both sides of the platter provide the necessary clearance for proper scale operation if you are installing a scanner-scale (you won't need to provide additional gap for that).

Figure 16. Mounting the Scanner Flush

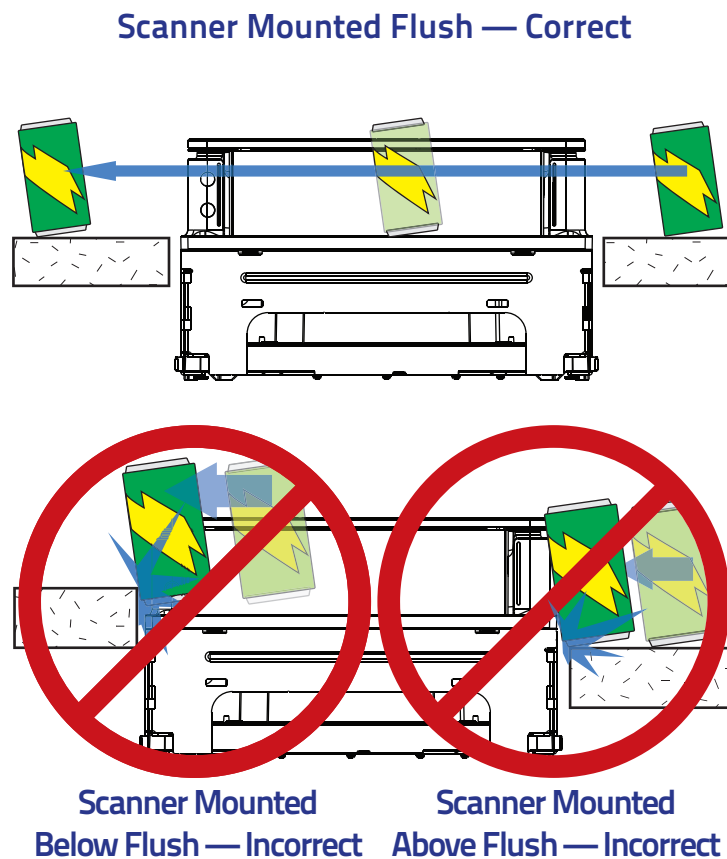

1. Remove the All Weighs™ Platter to gain access to the lift handles. Lift the top edge of the platter bezel as shown in Figure 17 and gently lift it from the scanner. If the top edge of the platter is blocked, you may find it easier to grasp edges of the platter as shown by the blue arrows.

Figure 17. Removing the All Weighs™ Platter

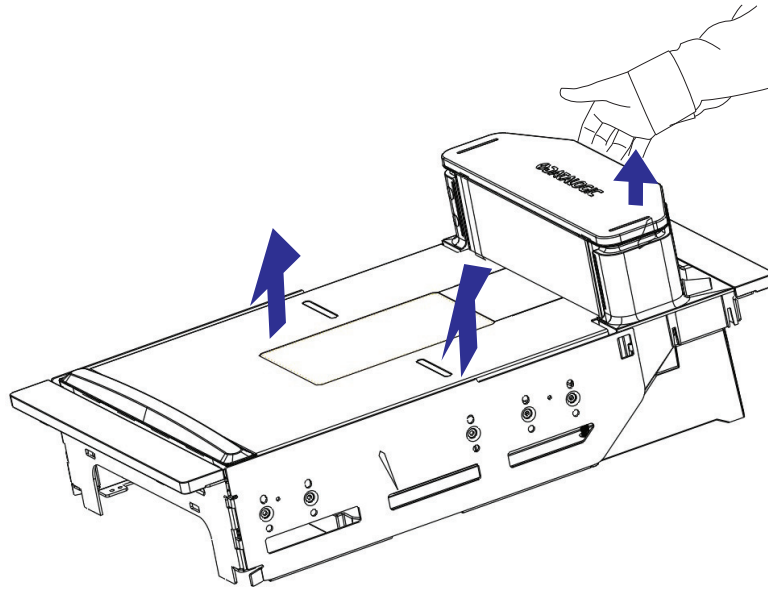

2. The scanner provides lift handles that must be rotated up into position for use as shown in Figure 18. When released, these handles should be allowed to rotate back down into their seated positions in the cavity. Use reasonable care when attempting to lift the unit using any features other than the lift handles.

Figure 18. Using the Lift Handles

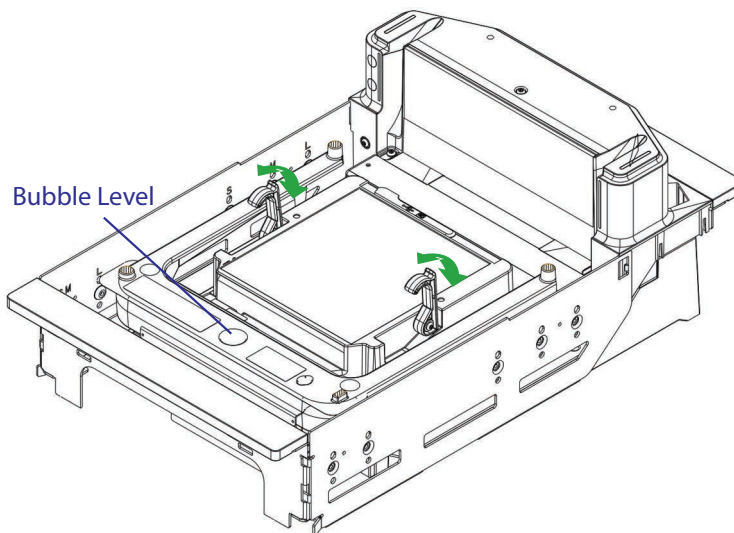

3. Lower the unit into the counter opening, ensuring that none of the cables are pinched, pierced or crimped.
4. View the bubble level (if present¹) located on the scanner's spider assembly to ensure the scanner is level. As shown in the insert of Figure 17, the air bubble should appear fully within the circle indicated. The air bubble can touch the circle,

1. The bubble level is present only on certain models.

but must not overlap it. Apply shims beneath the scanner flange or adjust the leveling feet to allow level installation.

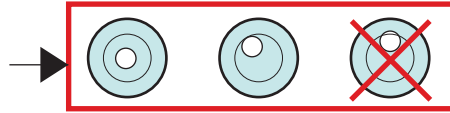

5. Mount the horizontal surface of the All-Weights Platter flush with the countertop to encourage slide scanning rather than lifting.
6. Position the centerline of the scanner read area 20.3 - 25.4 cm (8 - 10 inches) from the edge of the checkstand (cashier side).
7. Reinstall the All Weights™ Platter and verify that it is flush or just below flush with the countertop. This is necessary to provide smooth scanning from either direction. Make adjustments as needed to align the platter with the counter by moving support rails up or down, or consider installing screws in positions that will allow their use in adjusting the unit's position. Ensure that leveling is maintained if adjustments are made.

You have now completed installation and system integration of the scanner or scanner-scale. At this point, the scale must be calibrated and certified in accordance with the requirements of your state and/or local requirements. Refer to [Chapter 5. Calibration Procedures](#) for calibration details.

OPTIONAL REMOTE SCALE DISPLAY

Placement/Installation

When installing the optional Remote Scale Display, consider both the customer's viewing angle and the daily ambient light conditions anticipated at your installation site. Figure 19 shows available adjustment for the display head.

Lighting Considerations

The display(s) will be easily readable unless placed in direct sunlight or other very strong light sources. Light interference will not be a factor in most installations. For best viewing, the display head(s) can each be rotated up to 180° around the post and/or tilted 15° backward or forward.

Viewing Angle

The optimum display angle is directly facing the viewer. Tilt and rotation adjustments can be made for the Remote Display models as shown in Figure 19. To ensure that displays are easily readable for customers/cashiers of average height, display heads should be between 122 to 152 cm (48" to 60") from the floor.

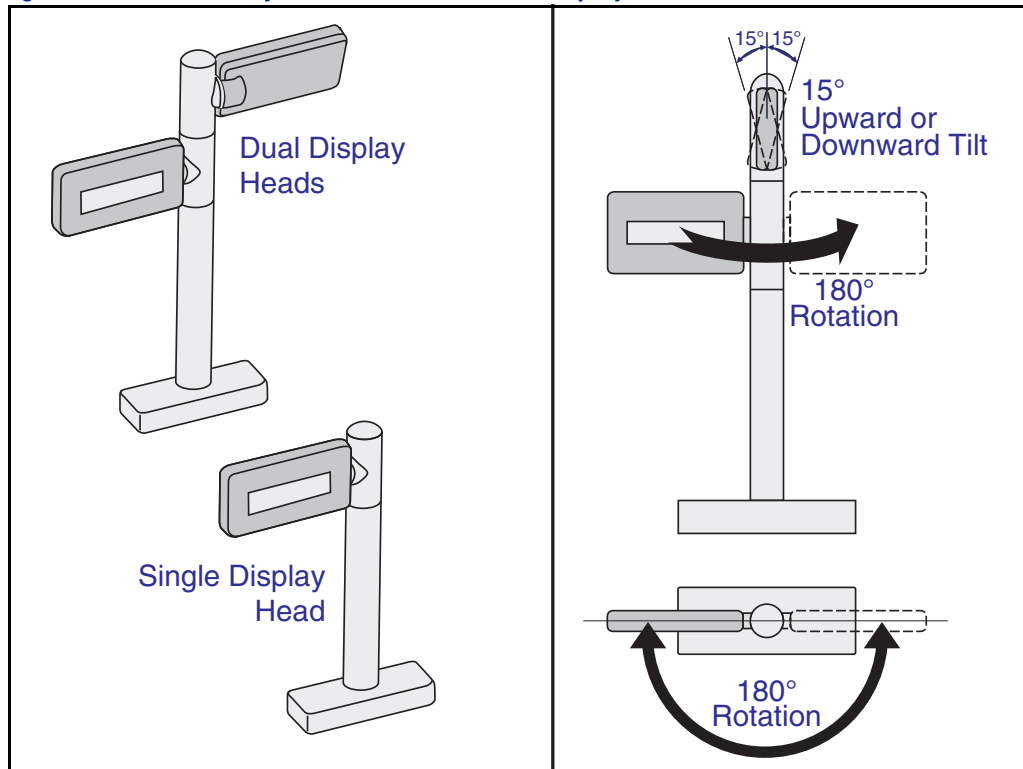

NOTE: Check with local Weights and Measures authorities regarding proper positioning of scale displays used in retail trade.

Figure 19. Modular/Adjustable Remote Scale Display

Remote Display Cabling

Your installation should also take into account the routing of Remote Display cabling. Ensure that distance and obstacles spanned by the routed cable will not kink, pinch or stretch it. Also keep in mind you may need to drill a hole through which to route it.

Placing and Installing the Remote Display

1. Determine where you want to install the Remote Scale Display based on your counter design, the viewing angle, lighting considerations and cable routing discussed previously. Reference Figure 20 for the display's physical dimensions. Optimally, the display(s) should be approximately eye level to the viewer(s).
2. Use the template provided in Figure 22 to mark locations of the mounting screw and cable routing holes.
 - The mounting screw holes are on 8.5 cm (3.5") centers. The cable can either be routed through a 8.51cm (3.35") diameter hole directly under the mounting base or through the cutout in the back of the base.
3. Drill the mounting screw holes using a drill bit of the appropriate diameter for your mounting screws or bolts.
4. Drill the cable routing hole using a 19 mm ($\frac{3}{4}$ ") drill bit (optional).

Figure 20. Remote Display Physical Measurements

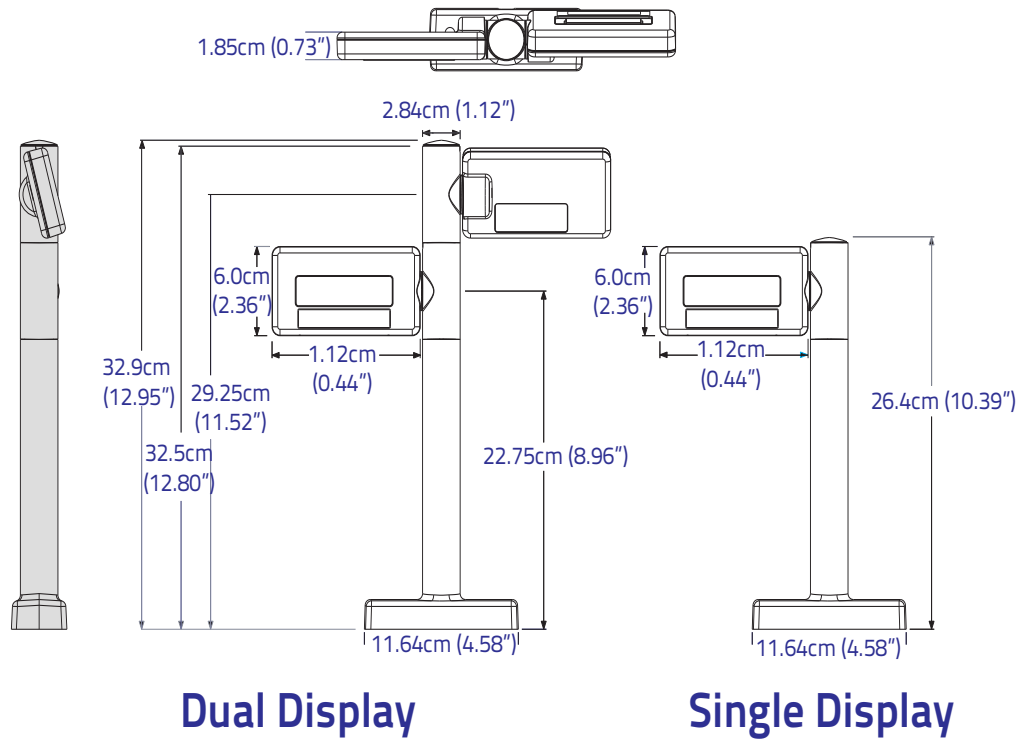

5. Feed the entire length of the Remote Scale Display interface cable through the cable routing hole so that the assembled Remote Scale Display can be positioned over the mounting screw holes.
6. Install mounting screws or bolts to complete the installation of the Remote Scale Display. Take care not to pinch or pierce the interface cable while securing the Remote Scale Display to the checkstand.

Figure 21. Remote Scale Display Mounting

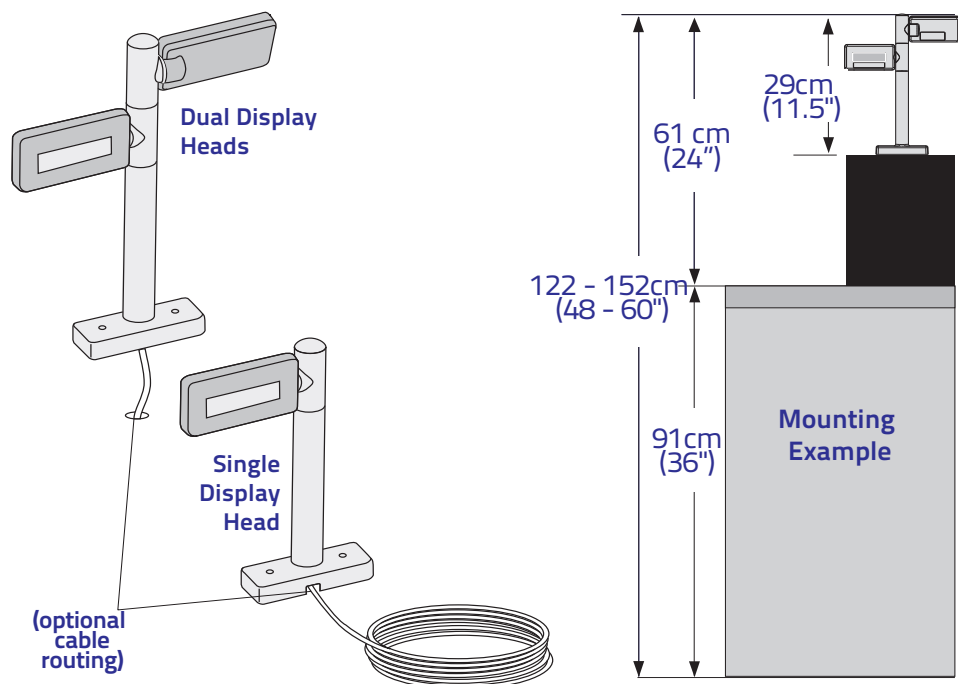
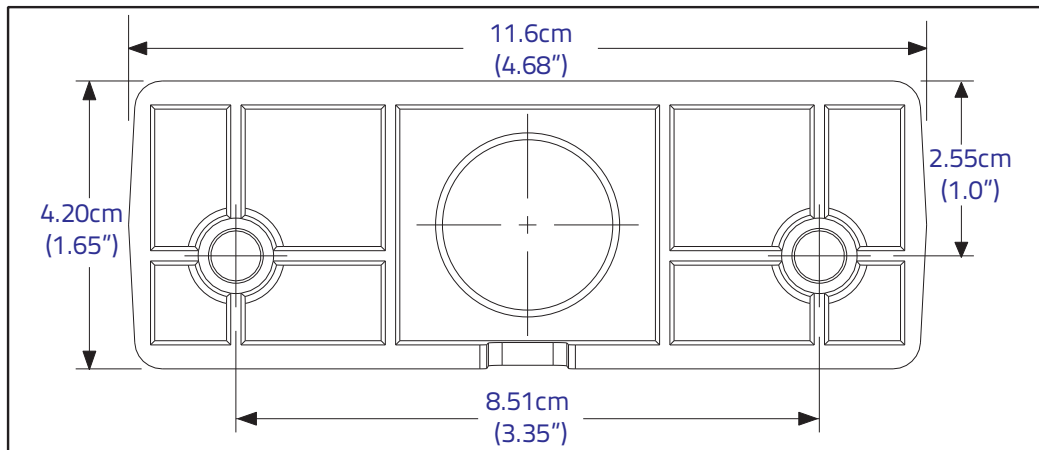

Figure 22. Remote Scale Display Mounting Template



CHAPTER 3

OPERATION AND MAINTENANCE

The information contained in this section describes how to operate and maintain the scanner, scale and EAS system. Topics include “how to’s” on scanning, EAS tag deactivation, weighing, re-zeroing the scale, removing the top cover and cleaning the upper and lower windows.

SCANNER MAINTENANCE

1. Keep scanner windows clean. This will improve productivity and reduce rescans.
2. Replace scanner glass when excessive scratches are evident.

SCANNER USAGE

1. Minimize handling of heavy/bulky products. Leave these items in the cart and use an alternative entry method such as key entry of short PLUs, LaneHawk® BOB (Bottom Of Basket) technology, or handheld scanning.
2. Regularly train cashiers in proper scanning methods and ergonomics principles, such as:
 - Develop a smooth fluid motion during scanning, sharing work equally between hands.
 - Use the entire hand for grasping and lifting items.
 - Since the scanner reads labels on multiple sides, there should be no need to particularly orient a bar code toward the scanner windows.
 - Develop efficient scanning motions, not necessarily faster hand movements. Simply slide the item across the scanner’s horizontal window with as little orientation motion as necessary.
 - Leave items in an upright position; do not lift and tilt.
 - Learn how the scanner functions and where the scanning area is located.
 - Do not favor either the vertical or horizontal window; slide items across the scanner in their natural orientations on the checkstand as much as possible.

Scanning Items

To scan items, slide or push them over the scanner as shown in Figure 1. Also see Figure 2 for views showing the scan zone. The scanner will work equally well with either a left-to-right or right-to-left motion through the scan zone. There is no need to reorient an item's bar code since the scanner can read the left, right, front and back side, as well as the top and bottom of an item.



NOTE: “Limited Scanning Mode” is entered by default by interfaces such as USB and IBM until a Point Of Sale (POS) terminal enables scanning. Labels are “chirped” while in this mode.

Figure 1. Scanning an Item

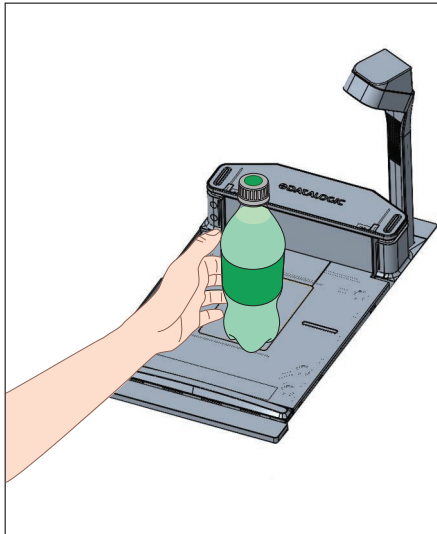

Proper Scanning Technique

The scanner was designed to provide the ultimate in ergonomic enhancements for Point-Of-Sale (POS) scanning. To take advantage of these advancements:

Practice the techniques below to improve scanning efficiency:

- Move the product across the horizontal window (See Figure 1).
- Since the scanner reads labels on all four sides plus the top and bottom, don't favor either the horizontal or vertical scan windows. Keep items in their natural orientation.
- Remember to slide or push items rather than picking them up. By avoiding any gripping, twisting and rotation of your hands and wrists, you can prevent repetitive motion injuries. This technique also relieves you from lifting possibly thousands of pounds per day.
- Develop a smooth fluid motion during scanning, sharing work equally between hands.
- Use the entire hand for grasping and lifting items.
- Develop efficient scanning motions, not necessarily faster hand movements.
- Learn typical locations for bar codes on packages; avoid “flipping” or rotating the items during scanning.
- Learn how the scanner functions and where the scanning area is located.

Proper Weighing Technique (Scale Models)

1. The L-shaped All-Weights™ platter allows you to place items anywhere on its surface, including leaning against its vertical section, to be weighed accurately. The raised lip on the end also provides a convenient way to ensure items do not rest on the counter or other non-weighing surfaces. (Reference Figure 2a.)



NOTE: It is important that items rest entirely on the platter for their full weight to be accurately recorded. An optional ScaleSentry™ feature can be employed to help prevent the occurrence of item overlap onto non-weighing surfaces. See the following section for more information about this feature.

Figure 2. L-Shaped Platter, Item Placement and ScaleSentry™

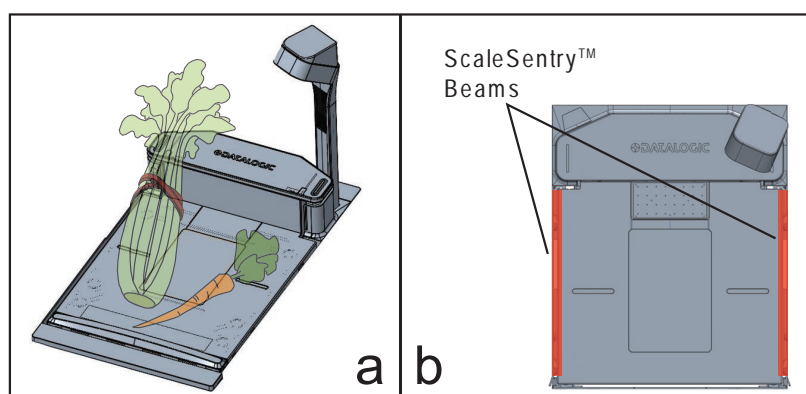

2. Once weighed items are in place, enter PLU (price Look-Up) data as described in your POS system instructions. Item weight is displayed on the Remote Display and/or the host display.
3. Remove the item from the weigh platter.

Using the Optional ScaleSentry™ Feature

If the scanner-scale has been equipped with ScaleSentry™, infrared (IR) beam(s) are emitted along one or both long edges of the platter (See Figure 2b). During the process when items are being weighed, if an item approaches too closely or extends past the edges of the weighing surface, this is detected by the IR beam(s) and the scanner will indicate a ScaleSentry event by illuminating its ScaleSentry indicator LED and/or sounding a special ScaleSentry tone. These indications are configurable, and can be enabled or disabled using the [Programming](#) section of this manual.

Depending upon how ScaleSentry is configured, a scale transaction cannot be completed until: 1) The item(s) are physically repositioned to rest fully on the platter without overhanging the side, or until 2) The ScaleSentry button is pushed, overriding the condition, or 3) It can also be configured to only indicate the error, but still transmit the weight to the POS.



NOTE: This function may not apply to Adaptive Scale models.

Deactivating Security Labels



NOTE: Two different types of Electronic Article Surveillance (EAS) systems can be optionally enabled for certain scanner models. Your system may or may not be equipped with EAS deactivation functionality.

Checkpoint

Checkpoint® systems require a wired connection as shown in . When this system is armed, Checkpoint EAS-tagged items are automatically deactivated as they are slid over the scanner's platter area during scanning.

Sensormatic

Sensormatic® Ultra-Max®, Ultra-Strip® II and III EAS tags can be detected and deactivated by a system that is equipped to do so. This is accomplished by means of a deactivation antenna mounted under the scanner platter. EAS tags should be brought within five inches of the antenna to be deactivated.

EAS Deactivation Modes

Three modes of initiating deactivation are selectable via scanner programming (reference [Chapter 1, EAS Mode](#) in this manual):

- Coupled Mode — Deactivation occurs only after item bar codes are read by the scanner.
- Decoupled Mode — Deactivation is independent of the scanning function
- Hybrid Mode — The EAS system is armed whenever the scanner is enabled and the deactivation beep is sounded when an EAS tag is deactivated.



NOTE: The EAS system must be functional to implement any of the EAS Modes. If the EAS system is not active, error code 9 will be displayed in the Health & Status Indicator (see [Figure 2](#)).

EAS Deactivation Indicators

The scanner can be programmed to beep in acknowledgment of deactivation or upon deactivation failure.

For more information about Beeper, see the LED/Audio Indications & Controls section of this manual. Also reference the programming section for its configurable features.

Deactivating the EAS System when failed

In cases of EAS system failure or malfunction, a scanner can be enabled to operate independent of the EAS deactivation function. This is accomplished by pressing and holding the EAS Manual Deactivation Push Button for three seconds. The scanner will sound three high-pitched beeps upon bypassing the EAS function in this manner. When in this state, the scanner's EAS LED will flash slowly red, as well as the FRU Status LED, which will slowly flash error nine (9).

OPERATIONAL CONTROLS

The function of scanner and scale controls and indicators is listed in LED/Audio Indications & Controls . Turn to that appendix for full details.

OPERATIONAL MODES

The scanner or scanner/scale features a number of modes that are important to both the user and system support personnel. These modes can be combined into three groups: pre-operational, operational, and additional functions. The following describes these modes and how and when they are seen.

Power-Up/Selftest & Pre-Operation

Pre-Operation describes those steps that must be successfully completed before the scanner sounds the initial good read tone and illuminates the lamps indicating the scanner and/or scale are ready for operation. These steps include Power-Up Selftest, Error Reporting, and Operational Configuration.

Power-Up/Selftest



NOTE: This function does not apply to Adaptive Scale models.

Power-Up Selftest begins when power is applied. The scanner's software immediately begins the testing sequence to verify that all systems are functioning properly. This routine, which only takes a few seconds, checks all the functions of the scanner, EAS deactivation system, scale, remote scale display and interface prior to indicating that it is ready for operation.



NOTE: A tone indicating Selftest is complete is a configurable feature. See Chapter 1, Power-up Tone Control in this manual.

Error Reporting

If a fatal error is detected during Selftest or operation, the unit will not advance to Normal Operation Mode. Selftest diagnostics will cause the unit to sound a long, low tone and/or display an error message on the Health & Status Indicator indicating where the failure occurred. These messages are coded to assist the repair technician in identifying the failed component. If the error is with the EAS deactivation system, the bottom-most LED will flash red. If an error is indicated, make note of it and contact your supervisor or technical support representative. A table containing descriptions of these error codes is included in [Chapter 4, Problem Isolation](#).

If a non-fatal¹ error is detected (such as a EAS deactivation system error), the unit will sound a long, low tone and display a number on the Health & Status Indicator. The unit will advance to Normal Operating Mode, but performance may be affected until a correction or repair is made.

Operational Configuration

Once Selftest diagnostics have been successfully run, a tone is emitted (if configured to do so, and the unit enters an operational configuration state. The scanner or scanner/scale will automatically load your specific interface settings which are required to com-

1. Scanner behavior under non-fatal error conditions is configurable. See [Chapter 6, Programming](#) for more details.

municate with the host system. There are two conditions that must be met before the unit can enter Operating Mode:

- No bar code label can be in the scan volume while the unit is in this state. Progress is halted until the label has been removed, thereby ensuring that no extraneous bar code data is sent to the host.
- If your scanner has a scale, the scale cannot be in motion (usually caused by excessive vibration in the checkstand) for this test to succeed. A “Scale in Motion” status will be indicated by displaying a period and the applicable weight unit (lb . lb or kg . kg) that is selected.
- The scale must be able to “capture” zero weight. The $\blacktriangleright 0 \blacktriangleleft_x$ display will be seen if there is a weight on the platter at power-up. Removing the weight or pressing the Scale Zero Button should allow the scale to find zero.
- When the scanner or scanner/scale completes its Selftest successfully, it emits a tone (when configured to do so) and enters Operating Mode.

Operating Mode

Operating Mode includes Normal Operation (scanning, EAS deactivation and weighing) and Sleep Mode. These two modes are most commonly observed by the user/operator.

Normal Operation

This condition is indicated by the scanner green LED and the EAS deactivation LED both being on dim and steady. For scanner/scale models, the scale yellow LED indicates that the scale senses a weight of zero on the platter. If you have a scanner without scale model, the yellow lamp will not be lit when the scanner is ready for scanning.



NOTE: Yellow and Green LED indications are configurable. Your scanner may not be programmed to operate in the standard manner described above.

Once the scanner enters Normal Operation, it begins a countdown sequence. If there is no activity during a preset period of time (also called time-out¹), the unit will shut off in order to prolong the life of the electrical components. Once the scanner has timed out, it enters Sleep Mode.

Sleep Mode

After the scanner has been left idle for a preset period of time, the unit goes to sleep. This state is called Sleep Mode, and is indicated by a “slow” blink of the green light (blinking at a 2-second rate). To wake up the unit, press anywhere on the weigh platter (scanner/scale models only), press the Volume Selection switch or wave your hand in front of the vertical window. The unit will recognize any of these signals as a wake-up call and instantly return to Normal Operation.

1. “Timeout” and “Sleep Mode” time delays are programmable features that can be selected through use of the programming labels included in [Chapter 6, Programming](#).

ADDITIONAL FUNCTIONS

Additional scanner and scale functions include programming, running scale diagnostics, initiating a reset, zeroing the scale, and calibrating the scale.

Programming

When your scanner or scanner/scale is shipped from the factory it is configured to work with the POS system interface at your store and read the bar code symbologies you designated. If you need to change this configuration information for any reason, [Chapter 6, Programming](#), contains special bar code labels for changing the unit's settings.

Diagnostic Mode

Refer to [Chapter 2, Scale Diagnostic Mode](#), for details about running scale diagnostics. Turn to [Chapter 4, Problem Isolation](#), for a description of error codes resulting from diagnostics.

Scanner and Scale Reset

The reset procedures and indicators are identical for scanner and scanner/scale models. As with any electronic equipment, it is sometimes necessary to reset the electronics. The reset procedure allows you to initiate a reset command to the scanner. This may be necessary if the POS terminal has been switched off or the store system has been reset while the unit is on. Reset can also be used to initiate and run the unit's internal Selftest routine.

Pressing and holding the Scanner Control Button for ten seconds initiates a reset, which is sounded by a rapid number of beeps. For more information, see the topic, [Power-Up/ Selftest & Pre-Operation](#) earlier in this section.

Scale Adjustments

The scale allows two user adjustments: zeroing and calibration. The first, and most frequently performed, is 'zeroing' the scale. This operation resets the scale's "at rest" reading to zero which must be within the range of -0.2 lbs.

(-0.9 kilograms) to +0.6 lbs. (0.3kg) since the last calibration. While the 'at rest' reading remains within the zero range, the scale will automatically adjust itself to true zero. The scale also automatically zeros itself on power-up if the weight present on the scale is within these defined limits.



NOTE: This function may not apply to Adaptive Scale models.

Zeroing the Scale

The zeroing operation may be performed by checkers and other store personnel. Pressing and releasing the Scale Zero Button should return the scale to Normal Operation. If the zero point moves out of the zero range due to debris accumulation or other causes, pressing the Scale Zero Button will not reset the zero point. In this case the weigh platter must be cleaned, debris chutes cleared of debris or the scale must be recalibrated.

With the scanner/scale powered-up and at operating temperature:

1. Remove everything from the weighing surface of the scanner/scale.

2. Press the Scale Zero Button. (See Figure 2).
3. The Zero¹ light will turn on and the display will show 0.00 lb (0.000 kg). If it does not, see [Chapter 4, Problem Isolation](#).
4. You have completed the scale zeroing function.

Alternatively, a reset (cycling power to the scanner) may also allow the scale to re-zero.

Calibrating the Scale

The second adjustment, calibration, defines and sets a standard reference weight range against which all product weights are compared. If your scale is set for weighing in pounds, this range is 0 - 30 pounds, and, if your scale is set for weighing in kilograms, the range is 0 - 15 kilograms. The scale must be calibrated upon initial installation, whenever the scale cannot be zeroed, when the scale diagnostics indicate a calibration error, when the weighing measure (pounds or kilograms) is changed, or when the scale module has been replaced.

Normally, once the scale has been calibrated, the calibration must be verified and/or approved by a local regulatory body. In many areas, the scale calibration switch must be sealed before being placed into service. Consult the agency responsible for regulating weighing devices in your area to ensure that you are meeting all legal and regulatory requirements. [Chapter 5, Calibration Procedures](#), describes the calibration sequence and verification process.

Calibration can only be performed if the tamper seal that secures access to the Calibration Switch is broken and the switch cover is removed. Breaking the seal may *legally* render the scale inoperable until it has been recertified and a new seal attached. Consult your local regulations before removing the calibration seal if you are unsure of the legal requirements. Although the scale will physically continue to weigh products, a broken seal may require recertification by a proper authority as designated by your local laws.

1. Zero light operation is configurable.

OPERATIONAL MAINTENANCE

The scanner or scanner/scale will provide dependable service for many years. The following maintenance procedures will keep your scanner or scanner/scale operating at peak performance.

Cleaning

Exterior surfaces and scan windows exposed to spills, smudges or debris accumulation require periodic cleaning at least twice daily to assure best performance during scanning and weighing operations. Use a clean, lint-free cloth or paper towel dampened with a nonabrasive, mild, water-based window cleaner to wipe away stains, smudges, fingerprints, spills, etc. from the scan window and exterior surfaces (Figure 3a).

Figure 3. Cleaning the Scanner

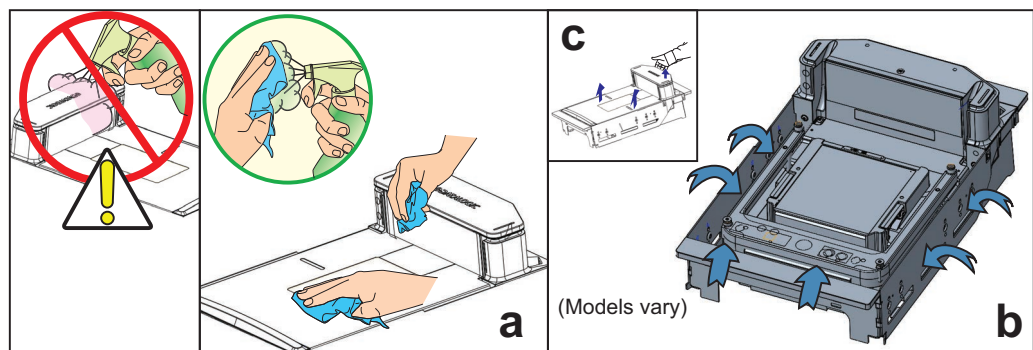

CAUTION: DO NOT use abrasive cleaning agents or abrasive pads to clean this product. Harsh chemicals, disinfectants, and cleansers can cause damage which will adversely affect scanning and weighing performance.

Daily, clean the debris chutes between the platter and the outer housing (Figure 3b). Most items can be cleared from the debris chutes by carefully running a thin, stiff object like a credit card along all sides of the weighing surface. If necessary, remove the platter (Figure 3c) to clean the debris chutes and drip rail.

Vertical Scan Window Replacement

The Vertical Scan Window installed in the All Weights™ Platter is replaceable. Follow these instructions to remove and replace a vertical window:

1. Handling by the features shown, remove the Platter as referenced in Figure 4 and gently lift it straight up and off of the scanner. If the top edge of the platter is blocked, you may find it easier to grip the edges of the platter as shown by the arrows.

Figure 4. Platter Removal

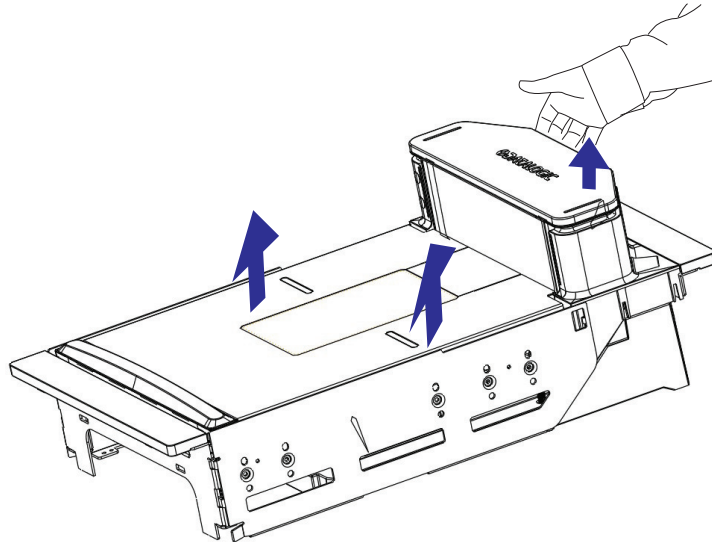

2. Carefully press in on the Vertical Window from the backside of the Platter to remove it (see Figure 5). Carefully dispose of any damaged glass.

Figure 5. Vertical Scan Window Removal/Replacement

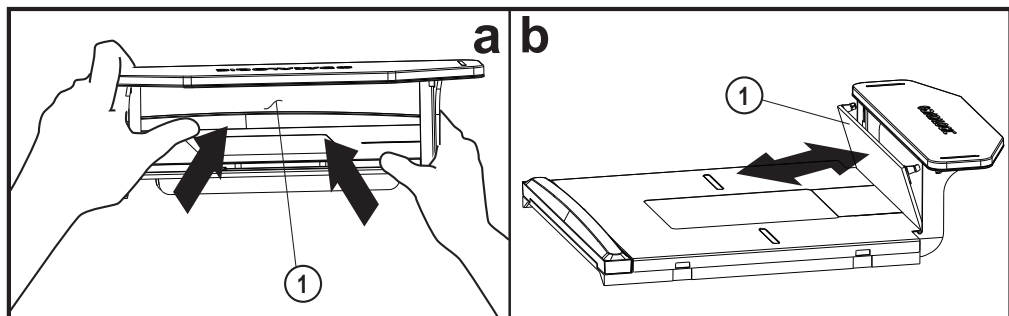

1	Vertical Window
---	-----------------

3. Carefully clean all adhesive or other obstructions from the Vertical Window frame area of the Platter.
4. Remove the adhesive liner from the adhesive strips on the window.
5. Tilt the Vertical Window into position as shown in Figure 5, then press around the front edges of the window to secure it in place.
6. Clean both sides of the Vertical Scan Window using a paper towel or lint free cleaning tissue dampened with a mild, water-based glass cleaner. DO NOT use abrasive cleaners or pads.
7. Reinstall the platter. Vertical Scan Window replacement is now complete.

CHAPTER 4

PROBLEM ISOLATION

The troubleshooting references provided in this section should be used in the event of a suspected functional problem. This information will assist you in identifying and resolving any problems.

The scanner/scale has a number of features that indicate when a scanner, EAS deactivation system, or scale problem occurs. The unit may:

- emit a series of tones
- light the Health & Status Indicator (FRU status) display
- flash its indicator LEDs
- display error codes on the Remote Display (if installed)

Three error reporting modes are used: Power-Up Selftest, Operational tests and Diagnostic tests. These test sequences are explained on the following pages.

Power-Up Selftest

The Power-up Selftest is a pre-operational series of tests that must be successfully completed before the scanner indicates readiness for operation. This pre-operational period is the time between power-up and normal operation during which the software, firmware and hardware are being tested. These tests ensure that all subsystems are fully functional before turning on. Refer to [Operational Modes](#) for a more detailed description of this and other scanner and scale modes.

Operational Tests

These are the tests that run continually during Normal Operation and Sleep Mode. Firmware checks all subsystems, accessory connections and the POS interface to verify everything is operating normally. If a problem is detected at any time, a long, low tone is sounded, an error code is shown on the Health & Status Indicator, and operation may be halted. If you press the Scanner Control Button at that time, a series of tones will be sounded that matches the error code displayed.

Diagnostic Tests

See [Chapter 2, Scale Diagnostic Mode](#), for details about running diagnostic tests for the scale. The remainder of this section describes these failure indications and includes troubleshooting flowcharts to help isolate the problem.



NOTE: This function does not apply to Adaptive Scale models.

DIAGNOSTIC PROCEDURES

Your Point-Of-Sale (POS) system may contain many components that operate as a system. Since almost all scanner or scale problems are caused by either the scanner, scale, POS terminal or communication links between them, these troubleshooting flowcharts focus on these components. Additionally, the optional Remote Scale Display, AC/DC Power Supply and their cables are potential problems addressed in this section.

The flowcharts provided in this section walk you through a diagnostic process that will isolate the failed component and instruct as to the corrective action required. Since internal scanner and scale components cannot be replaced by an operator or installer, most functional errors will require the assistance of a trained [Introduction](#) person. However, if the problem is caused by faulty cable, power supply or remote display, you can fix the problem by replacing the defective component and complete the installation.

ERROR CODES

If an error is detected, the scanner will sound a low tone and the LEDs on the left control panel will perform a “walking pattern” top to bottom indicating a failure. The Health & Status Indicator (Figure 2) will display an error sequence as follows:

1. An “equals” (=) sign always leads the sequence.
2. A (Field Replaceable Unit) FRU indication code is displayed next. For two-digit numbers, there will be a blank in between each number.
3. Next, a dash (or hyphen) is displayed (-).
4. Finally, the indicator will display an (Event Viewer) EVT code. This code provides more advanced details about the failure for use by the repair technician. If you are unable to resolve a problem, take note of the entire FRU Indication Sequence and be prepared to communicate it to Technical Support when you make contact for assistance.

Figure 1. FRU Indication Sequence

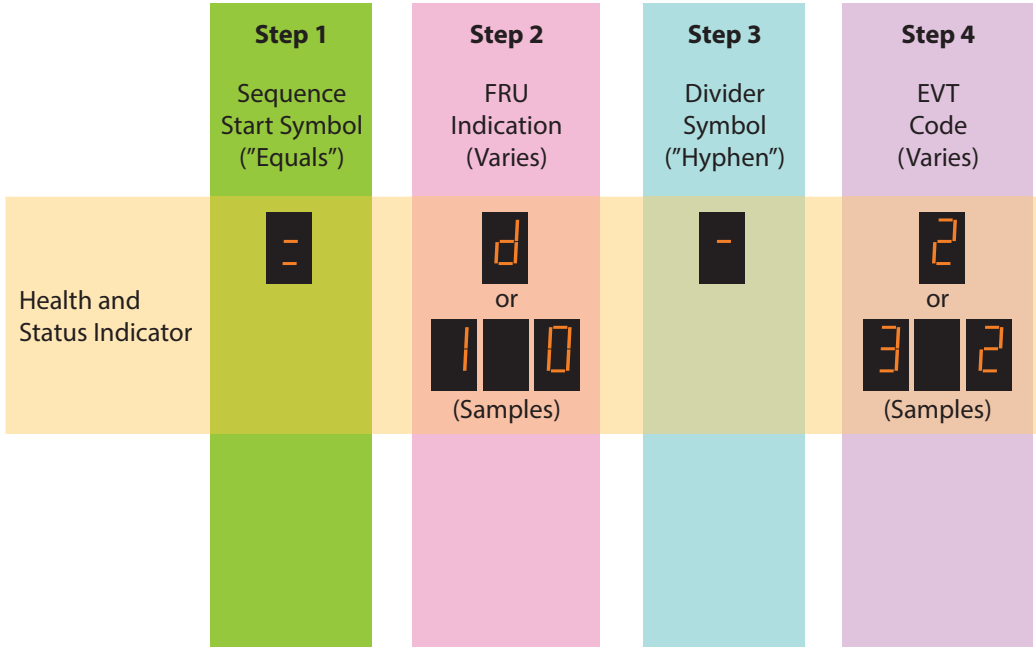
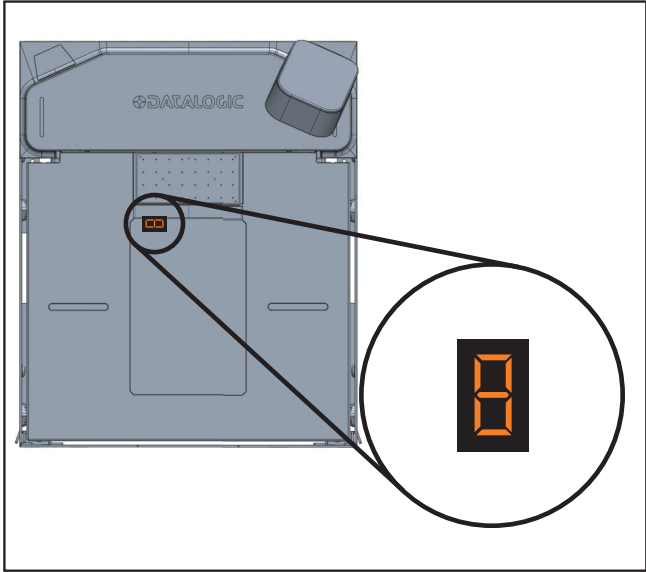

















Table 1 describes what the FRU indication codes in step 2 mean, and what corrective action might be taken for each.

Figure 2. Health & Status Indicator



NOTE: When troubleshooting, always remember to check all cable connections first before proceeding with other problem isolation steps.

Table 1. Error Code Table

Health & Status Indicator	Probable Cause	Corrective Action
	Configuration Error	Make sure the correct interface is selected, then scan the factory defaults bar code and reset the unit. Also, see Chapter 6, Programming , for details about configuring the scanner using programming bar codes.
	Host Interface	Unplug unit and call technical support personnel.
	Main Board	
	Reserved	
	ScaleSentry Error	See Chapter 6, Programming , for details about configuring the scanner for this optional feature, which may not have been purchased for your scanner.
	Interface Board	Unplug unit and call technical support personnel.
	Scale	See the topic Scale Error Reporting in this section for problem identification and corrective actions.
	Remote Display	Connect the Remote Display. If necessary, replace display or cable. Alternatively, you can disable the Remote Display using the programming procedures described in Chapter 6, Programming .
	Sensormatic Interface	No EAS communication. Check EAS cable connections and power to the EAS controller. Call technical support personnel.
	Control Panel	Call technical support personnel.
	USB Device	
	Scale Calibration	Proceed to scale calibration procedure.
	CPLD	Call technical support personnel.
	USB Host	Try resetting the scanner. If the problem persists, unplug the unit and call technical support personnel.
	Scale Configuration	See the topic Scale Error Reporting in this section for problem identification and corrective actions.

SCALE ERROR REPORTING

Scale diagnostics uses the optional Remote Scale Display and the Zero Status lamp to communicate specific scale failures.



NOTE: This function does not apply to Adaptive Scale models.

The following chart shows the Remote Display messages, the Scale Status lamp indication, the problem that the scale is experiencing and what action should be taken. When troubleshooting, always remember to check all cable connections first before proceeding with other problem isolation steps.

Remote Display	Scale Status LED ^a	Problem Description	Action Required
E_1	Flash, pause, 1 blink, long pause, repeat sequence.	Too much motion at power-up.	Check for stable installation. Change scale motion filter using the labels found in the Programming section; restart. If the problem persists, the scale may require calibration.
E__2	Flash, pause, 2 blinks, long pause, repeat sequence.	Calibration lost.	Call technical support personnel. Recalibrate; restart; recertify (if required).
E__3	Flash, pause, 3 blinks, long pause, repeat sequence.	Scale communication lost. Internal scanner/scale problem.	Call technical support personnel; report error.
E__4	Flash, pause, 4 blinks, long pause, repeat sequence.	Scale module failure.	Call technical support personnel; report error.
E__5	Flash, pause, 5 blinks, long pause, repeat sequence.	Internal software fault.	Call technical support personnel; report error.
Other Scale Reporting			
- 0 -	Off	Cannot zero at power-up or weight remains on scale for more than 4 minutes or weight has not returned to zero between POS weight requests ^b .	<ul style="list-style-type: none"> - Check debris chutes. - Verify that the weigh platter moves freely. - Remove item(s) from scale - Press Scale Zero Button - for more information. - If the scale still fails to zero, recalibrate the scale.

a. See , item #3.

b. This is a configurable feature.

FLOWCHARTS

The problem isolation flowcharts on the following pages allow you to identify and troubleshoot problems with your system.

Figure 3. Problem Isolation: Start

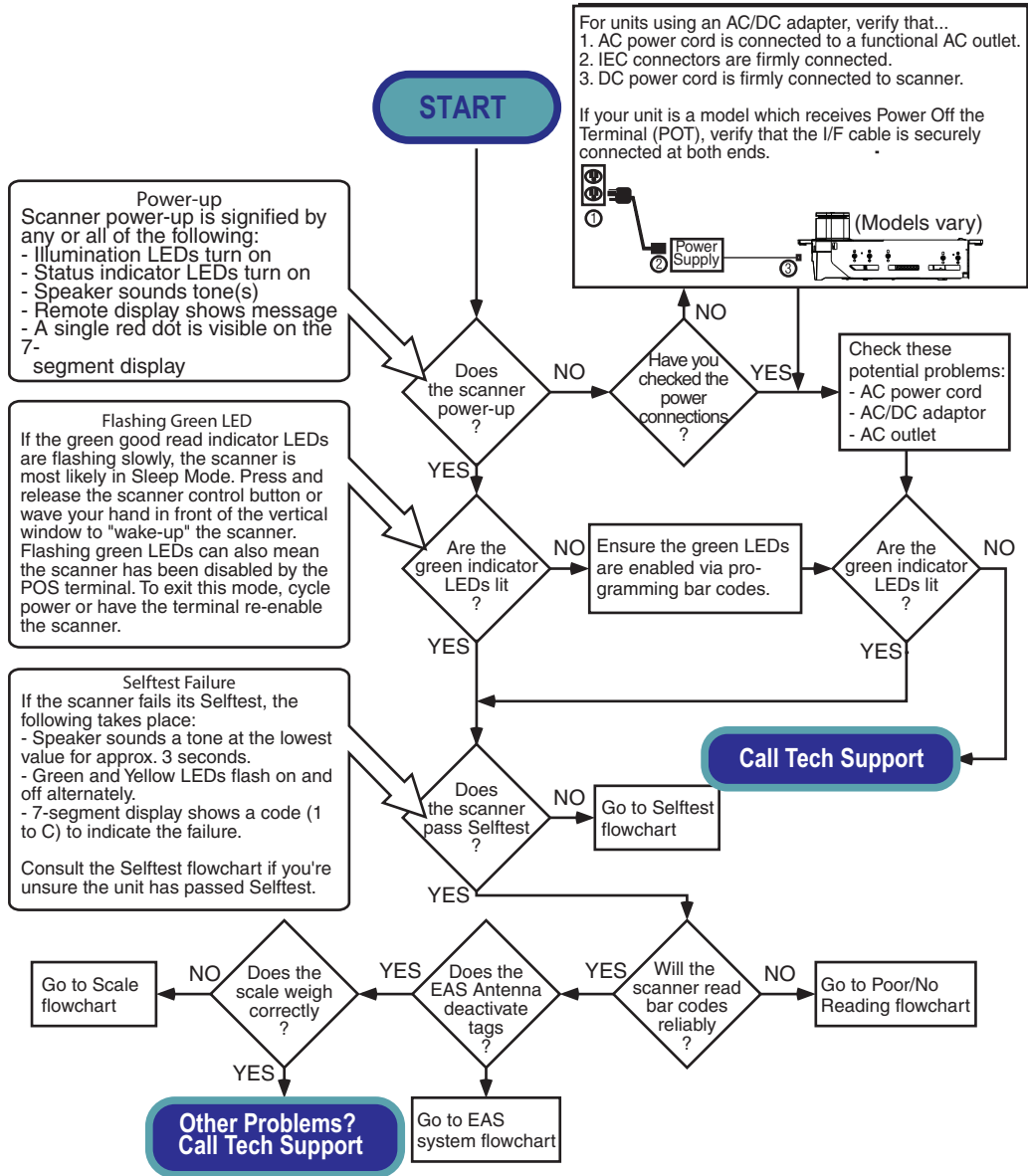

Figure 4. Problem Isolation: Selftest

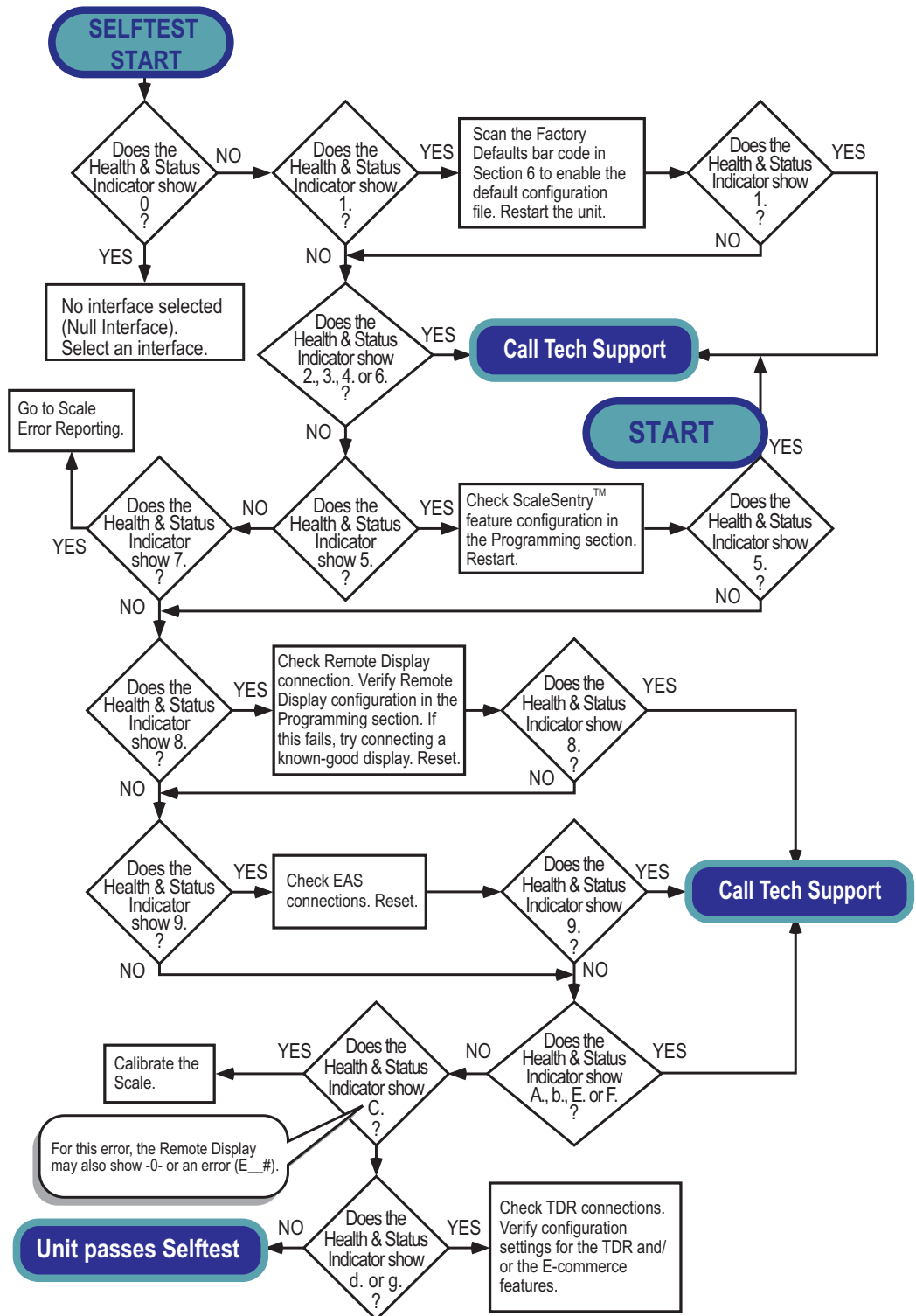
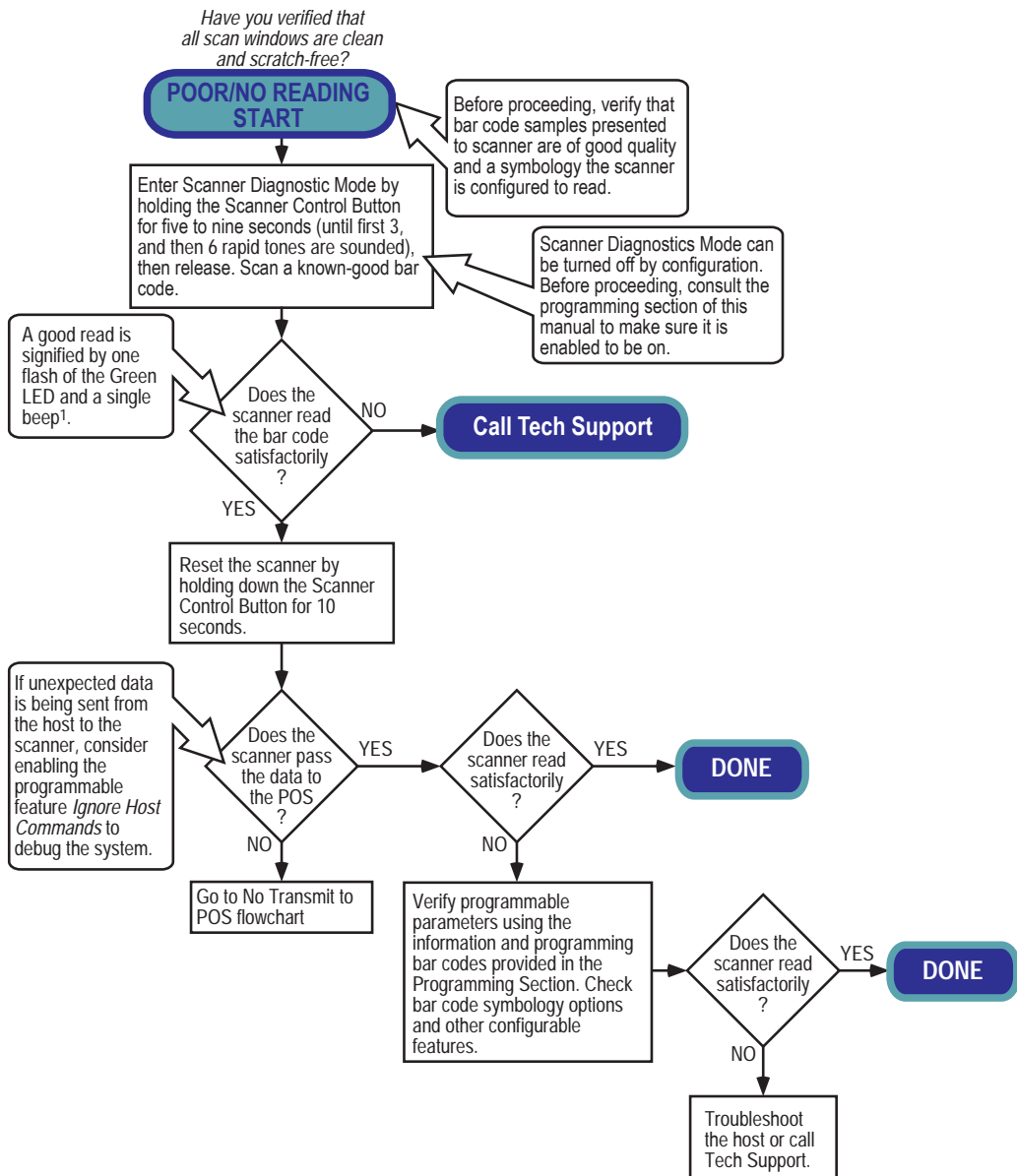

Figure 5. Problem Isolation: Poor/No Reading



¹ Green and Yellow LEDs and beeper indications are configurable features. Behavior may vary from that described here.

Figure 6. Problem Isolation: No Transmit to POS

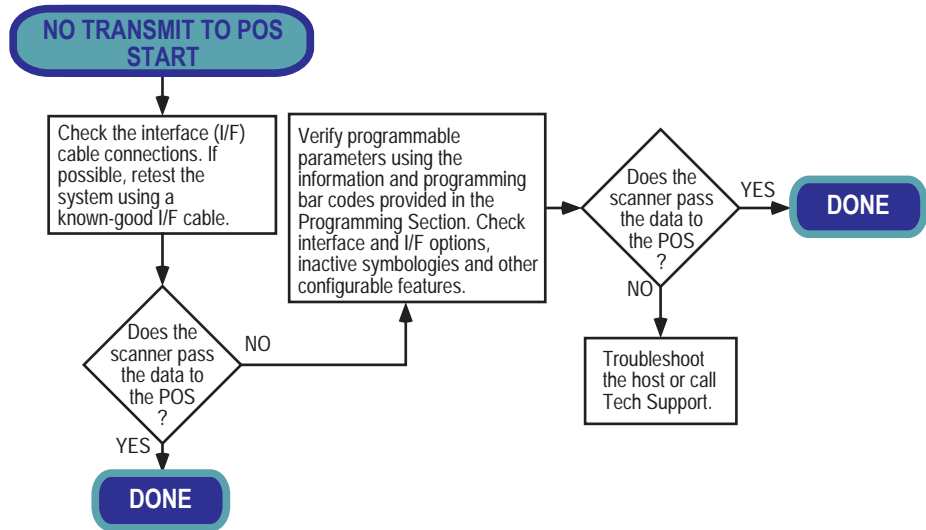

Figure 7. Problem Isolation: Scale

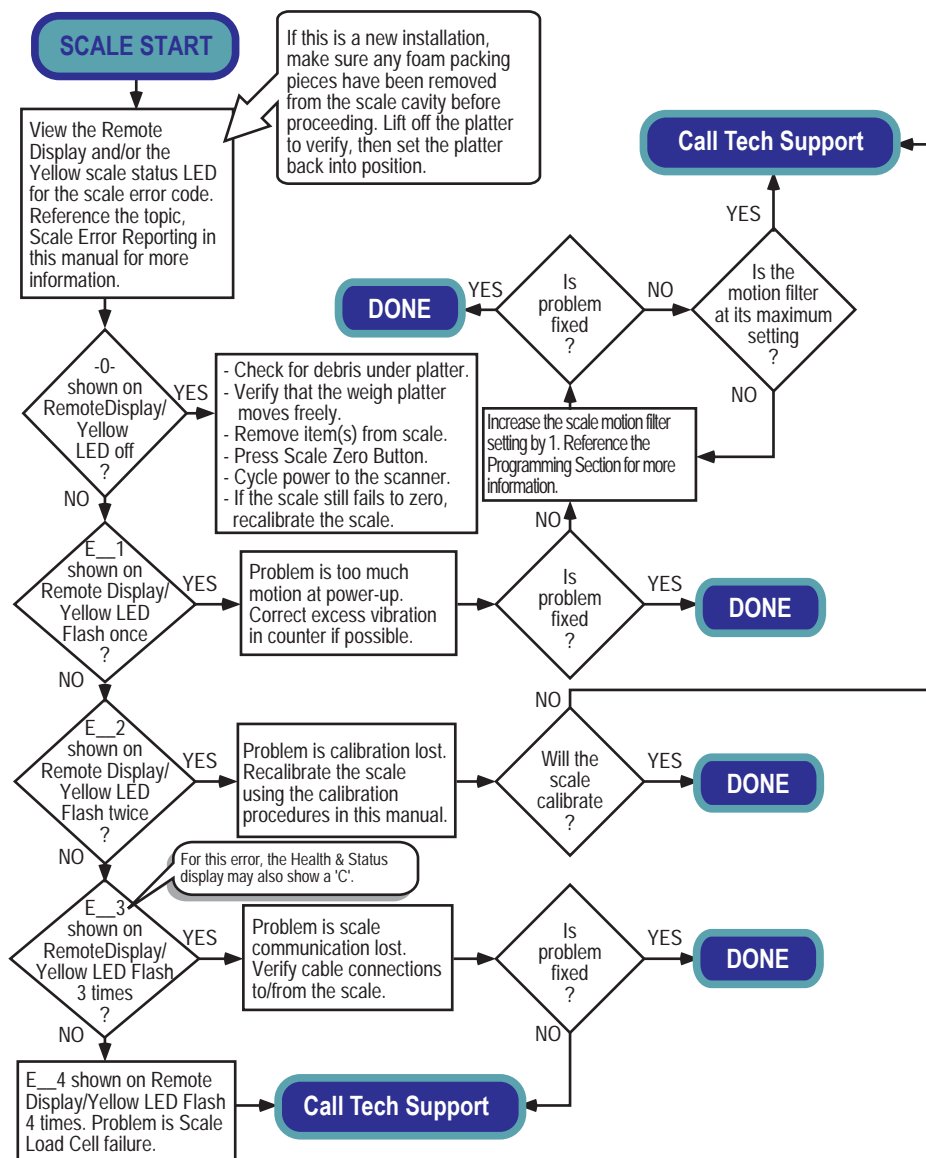

Figure 8. Problem Isolation: Remote Display

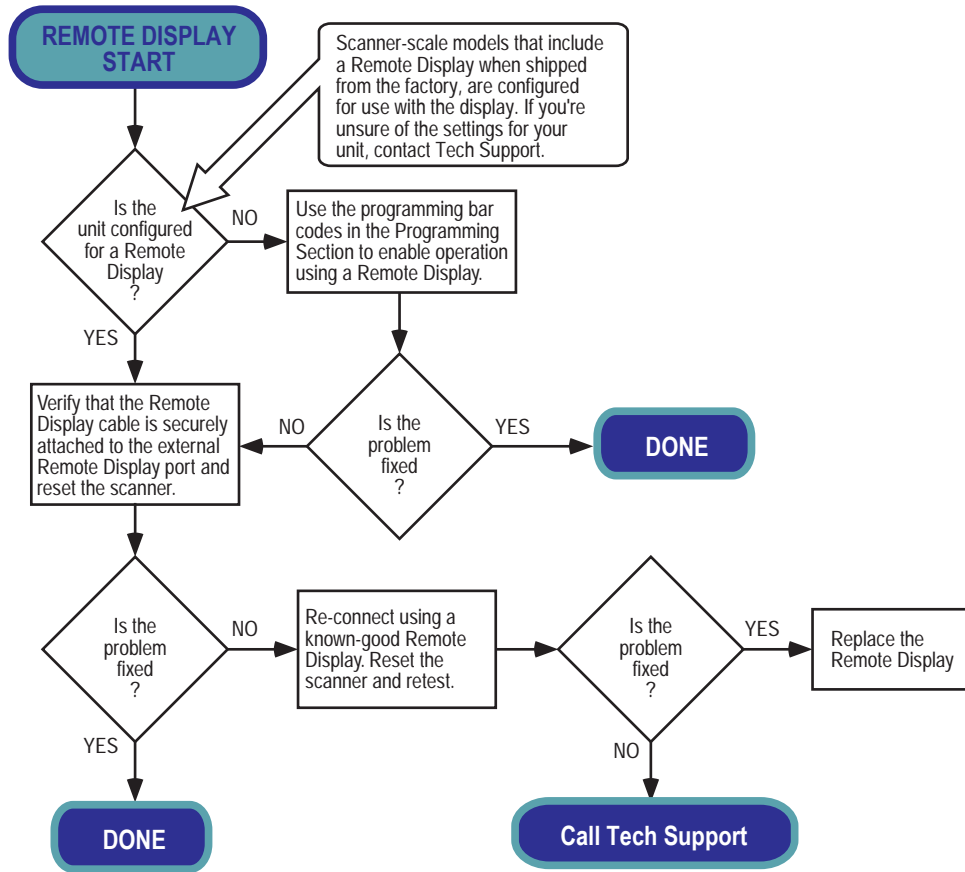
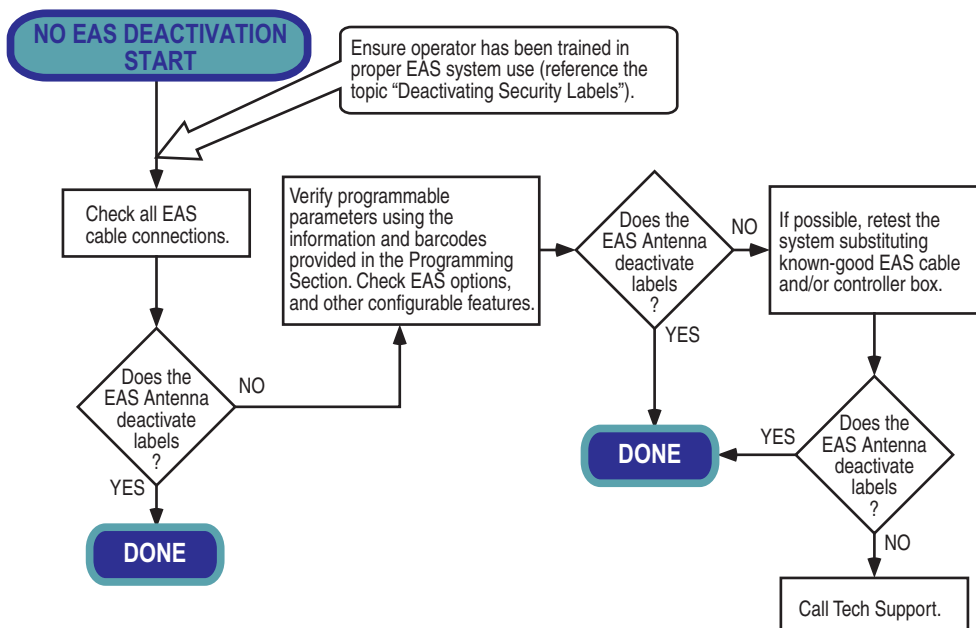

Figure 9. Problem Isolation: EAS System



CHAPTER 5

CALIBRATION PROCEDURES



NOTE: This section applies to scanner/scale models with single or dual interval. Make sure to follow the proper associated procedure for each of these options. Procedures specific to **Single** interval units are highlighted in a coral color. Procedures specific to **Dual** interval units are highlighted in a teal color.

These procedures are not applicable for adaptive scale models. Consult your adaptive scale documentation or the adaptive scale manufacturer for more information.

A number of situations require the scale to be calibrated. They are:

- at initial installation of the scanner/scale
- if the scale cannot be rezeroed
- when changing the weight measure from pounds to kilograms or vice-versa
- if diagnostics indicate a calibration error
- when removing/replacing any scale assembly or the Main Board
- when required by local regulations

Follow the procedures on the following pages to ensure that the scanner/scale will meet Weights and Measurement requirements.



Certification of the scanner/scale's weighing apparatus is subject to Federal, State and Local Weights and Measures statutes and is restricted to authorized government agencies and/or duly registered agents thereof. Anytime a scale is calibrated, it should be properly sealed with a lead and wire or paper seal before being placed into service.

It is your responsibility to check with the appropriate authorities in your area to ensure compliance with pertinent regulations before removing any official seals or placing a newly calibrated scanner/scale into service.



CAUTION: DO NOT apply a calibration seal to include the EAS antenna (if one is present). Reference Figure 2. If the antenna must be removed for other reasons, this would unnecessarily cause the scale to require recalibration.

DESCRIPTION OF CALIBRATION SEQUENCE

The Calibration Sequence sets the scale to an accurate reference point for weighing. This process involves the use of a Field Standard Weight Set (31.5-pounds) for calibration in pounds, (18.5-kilograms) for Metric calibration. Once calibration has been successfully completed, the scanner/scale uses the certified weight as a reference for subsequent weighing activities.

These verification procedures follow the *U.S. National Institute of Standards and Technology 44 Handbook* guidelines for bench/counter scale installations.

If any of these tests fail to meet the required weight indications, you must calibrate the scanner/scale. Refer to the calibration procedures in this section for the proper procedures.

You may be required by state and/or local regulations to have procedures other than these performed by a certified technician or verification official.

Access to the calibration switch should be restricted with a paper or a wire and lead seal after the calibration has been performed if required by your local regulatory agency.



NOTE: The Calibration Sequence must be performed without removing the scanner/scale from its installed position.

The following tools and supplies will be required to perform the calibration process:

- 31.5 pound Field Standard Weight Set¹.
(English calibration only).
- 18.5 kilogram Field Standard Weight Set².
(Metric calibration only).
- Lead wire or paper seal (as required by law).

MOTION TEST

This test verifies that the scale will not 'zero' when the weighing surface of the scanner/scale is in motion.

1. Verify that the Zero lamp is On and the Remote Display reads 0.00 pounds, 0.000 pounds or 0.000 kilograms.
2. Press lightly on the weigh platter of the scanner/scale with one hand and at the same time press and release the Zero switch on the operator's panel. The Zero lamp should turn Off and the Remote Display should not display 0.00 pounds, 0.000 pounds or 0.000 kilograms.
3. Remove your hand from the weighing platform and verify that the Zero lamp is On and the Remote Display reads 0.00 pounds, 0.000 pounds or 0.000 kilograms.

1. NOTE: Throughout the calibration procedures, specified weights may be achieved by using a combination of weight from this set. e.g. 20 lbs may be made up of one 10.00 lb. weight and two 5.00 lb. weights.

2. NOTE: Throughout the calibration procedures, specified weights may be achieved by using a combination of weights from this set. e.g. 10 kgs. may be made up of one 5.00 kg. and five 1.00 kg. weights.

AUTOMATIC ZERO SETTING TEST

This test verifies that the scanner/scale automatic zero setting mechanism is operating correctly.

SINGLE INTERVAL	DUAL INTERVAL
Place 0.006 pounds (3 grams for metric) on the center of the weighing platform. The entire weight must be placed on the weighing platform at once for this test to be valid. The Yellow LED should go Off and the Remote Display should read 0.01 pounds (0.005 kilograms).	Place 0.0035 pounds (1.6 grams for metric) on the center of the weighing platform. The entire weight must be placed on the weighing platform at once for this test to be valid. The Zero lamp should go Off and the Remote Display should read 0.005 pounds (0.002 kilograms).



NOTE: The scanner/scale has an adaptive zero capture mechanism that re-zeros the scale over time if there is a slow change in the zero level; thus, if all the weight is not placed on the weighing surface at one time, the Zero lamp will remain On and the Remote Display will read 0.00 pounds or 0.000 pounds (0.000 kilograms). When the weight is removed, the Zero lamp will turn off and the display will show a minus sign

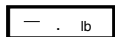

. Press the Zero switch to re-zero the scale.

PREPARING THE SCANNER/SCALE FOR CALIBRATION

1. Assure that the scanner/scale is stable.
2. Power-up the scanner/scale.
3. Allow the unit to reach temperature equilibrium for at least one hour. If the scanner/scale is already at room temperature, allow at least 15 minutes to acclimate.
4. Remove all weight from the weighing surface and ensure that there are no obstructions in the debris chutes of the scanner/scale.



NOTE: Do not pay attention to any message on the POS display.

CALIBRATING THE SCALE (POUNDS & KILOGRAMS)

1. Before proceeding, ensure that the scanner/scale has been prepared for this process by performing the preceding steps titled, [Preparing the Scanner/Scale for Calibration](#)
2. Verify that there are no obstructions under the weigh platter. Remove the weigh platter (L-Platter) and make sure that there are no obstructions in the debris chutes (see Figure 2).
3. If one is present, cut and remove the seal securing the calibration switch access cover. The seal may not be present if this is the initial installation of the scanner/scale.
4. Slide the cover to reveal the switch as shown in Figure 1.
5. Use a long, blunt object, such as the eraser end of a pencil to press and release the Calibration Switch and place the scanner/scale in Calibration Mode (see Figure 1c). **The scanner/scale will sound a tone, indicating that it is in Calibration Mode.** The Scale Status (yellow LED) will flash, indicating the scale is in Calibration Mode. If one is present, the Remote Display will show the message “ESCL” (empty scale).
6. Reinstall the weigh platter.
7. Press the Scale Zero Button. The Scale Status (yellow LED) will go out for approximately 10 seconds (or less) and the Remote Display (if present) will alternately display ---- and ____ until the scale is ready to proceed.
8. When the scale is ready, the Scale Status (yellow LED) begins blinking again, and the Remote Display (if present) will show the message “Ad20 (add twenty pounds)” or “Ad10 (add ten kilograms).” **The scanner/scale will also sound one tone if the scale is weighing in kilograms or two tones for pounds** if you don’t have a Remote Display.
9. Place the correct weight (twenty pounds for calibration in pounds, or ten kilograms for metric calibration) from the Field Standard Weight set, onto the center of the weighing area. Press the Scale Zero Button again.
10. The Scale Status LED extinguishes for approximately 10 seconds and the Remote Display (if present) alternately displays ---- and ____ until the scale is ready to proceed.
11. If the calibration was successful, **the speaker sounds a single tone**, the Scale Status LED begins blinking again, and “End-” appears in the Remote Display (if one is present).
12. If the calibration was not successful, the speaker sounds five tones indicating a scale failure, and the Scale Status LED will blink twice, strobe (fast blinks), and then continually repeat this sequence until reset. Remove all weight from the Weigh Platter, and repeat the procedure starting with step 8.
13. Press the Scale Zero Button again to permanently store the calibration data and exit Calibration Mode. You have completed the calibration of the scale. The unit’s calibration must now be verified as required by state and/or local weights and measures regulations. The verification procedure must be performed to assure that a scale will pass Weights and Measures requirements before it is placed into commercial/retail service.

You have completed the scale calibration procedure. Before replacing the Calibration Switch Cover and sealing the scale, you must now continue with the calibration verification tests to complete the scale’s calibration. If you are weighing in pounds, continue with the following procedures to verify that the scale was successfully calibrated and that it weighs properly. If you are weighing in kilograms, turn to the instructions titled, “Calibration Verification (Kilograms)” on page 75.

Figure 1. Calibration Cover and Switch Location

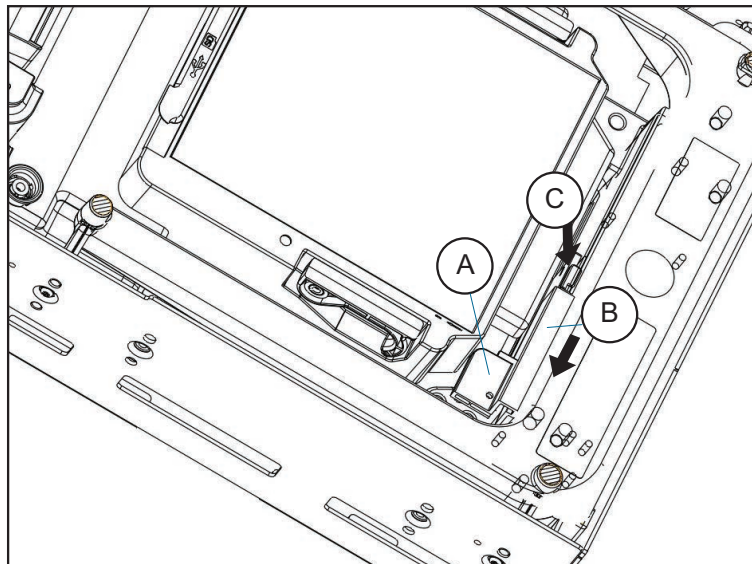

A	Calibration Seal Location	C	Calibration Switch Opening. Use a long, blunt object to reach in and press the Calibration Switch.
B	Calibration Access Cover		



NOTE: If an EAS antenna is present, it must be lifted in order to access the calibration switch.

Figure 2. Moving the EAS Antenna

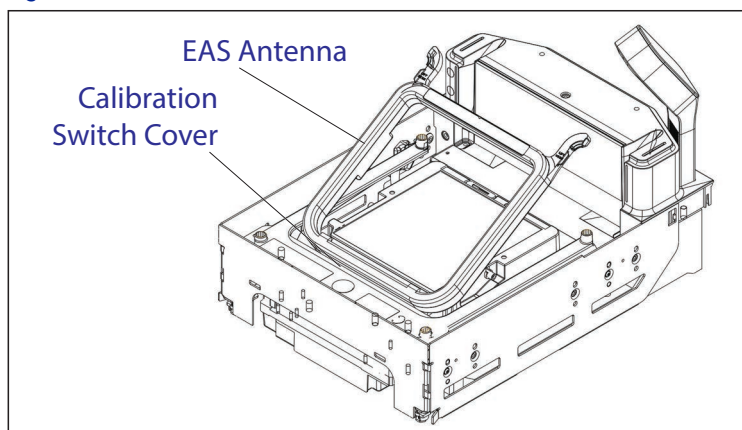

CALIBRATION VERIFICATION (POUNDS)

Once you have completed the calibration sequence, you may be required to perform these step-by-step verification procedures. These procedures follow the *National Institute of Standards and Technology Handbook-44* guidelines for grocery scale installations. You may be required by state or local law to have these procedures performed by a certified technician or verified by a proper official.

These calibration verification procedures cover five (5) different tests:

- Increasing-Load Test
- Shift Test
- Blanking Test
- Decreasing-Load Test
- Return to Zero Test



NOTE: If the scale fails any of the following tests, go to Chapter 4, Problem Isolation, and follow the troubleshooting procedures for SCALE FAILURE.

Increasing-Load Test (Phase 1).

SINGLE INTERVAL	DUAL INTERVAL
This test checks Scale operation with 5, 10 and 15- pound weights.	This test checks Scale operation with 2.5, 5.0 and 7.5-pound weights.
1. Check that the display reads 0.00 lb. when at rest with nothing on the weighing surface. (The Zero Status LED is steadily lit).	1. Check that the display reads 0.000 lb. when at rest with nothing on the weighing surface. (The Zero Status LED is on steady).
2. Place a 5-pound weight on the center of the weighing surface and check that the display reads 5.00 lb.	2. Place a 2.5 pound weight on the center of the weighing surface. Verify that the Remote Display reads 2.50 lb.
3. Place an additional 5 pounds on the center of the weighing surface and check that the display reads between 9.99 and 10.01 lb.	3. Place an additional 2.5 pounds (5 pounds total) on the center of the weighing surface. Verify that the Remote Display reads between 4.995 and 5.005 lb.
4. Place an additional 5 pounds on the center of the weighing surface and check that the display reads between 14.99 and 15.01. Remove the weights and verify that the display reads 0.00.	4. Place an additional 2.5 pounds (7.5 pounds total) on the center of the weighing surface. Verify that the Remote Display reads between 7.495 and 7.505. Remove the weights and verify that the display reads 0.00.
5. You have completed the Increasing-Load Test (Phase 1).	5. You have completed the Increasing-Load Test (Phase 1).

Shift Test (6 Pounds Dual Interval ONLY)

The Shift Test checks to ensure that items placed anywhere on the weighing surface of the scanner/scale are weighed properly. Refer to Figure 3 when performing this test.

DUAL INTERVAL
1. Place and remove, in succession, a 7.5-pound load on the center of each of the four quadrants: 1, 2, 3, and 4, (as shown in Figure 3) of the scanner/scale's weigh platter. Verify that a reading of between 7.495 and 7.505 lb. registers, under load, in each quadrant tested. Check that the display returns to 0.00 between each load.
2. After verifying the accuracy of each quadrant of the weighing surface, remove all weight from the scale. This completes the 7.5 pound Shift Test.

Figure 3. Shift Test

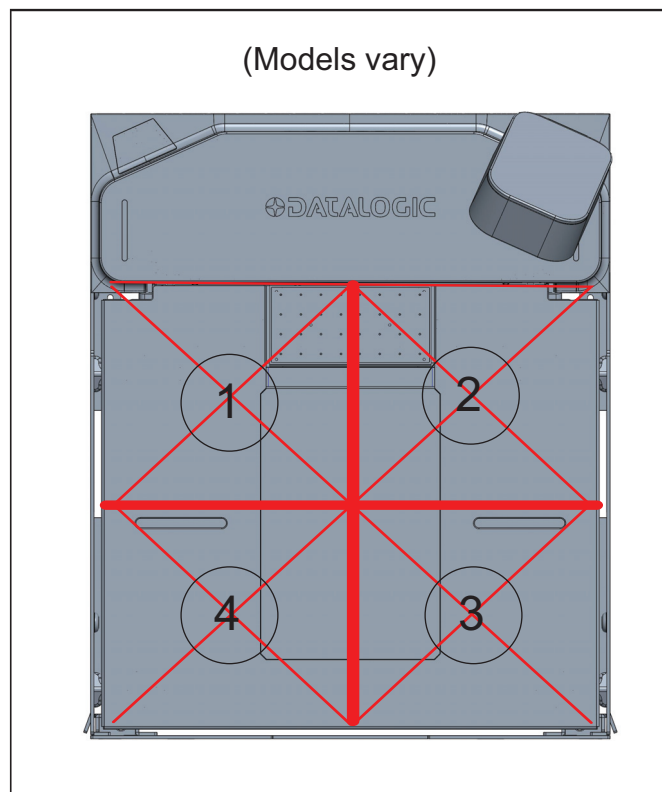

Increasing-Load Test (Phase 2 Dual Interval)



NOTE: The upper limit of the scale is configurable according to the POS interface type and may not necessarily be set at 30 lbs, which is the standard setting. For this test, continue to place weights in 2-lb increments only up to the upper weight limit set for your scale.

DUAL INTERVAL	
After completing the Shift Test, you must complete the Increasing Load Test using 10.0, and 12.5 and 15 pounds of weight.	
1.	With the scale starting at zero, place 10.0 pounds in the center of the weighing surface and check that the display reads between 9.995 and 10.005 lb.
2.	Place an additional 2.5 pounds (12.5 pounds total) in the center of the weighing surface. Check that the display reads between 12.495 and 12.505 lb.
3.	Place an additional 2.5 pounds in the center of the weighing surface increasing the load to 15.0 pounds, and check that the display reads between 14.99 and 15.01 lb. Remove the weights and verify that the display reads 0.00.
4.	You have completed the Increasing-Load Test (Phase 2).

Shift Test (10 Pounds)

The Shift Test checks to ensure that items placed anywhere on the weighing surface of the scanner/scale are weighed properly. Refer to Figure 3 when performing this test.

SINGLE INTERVAL	DUAL INTERVAL
1. Place and remove in succession, a 10-pound load on the center of each of the four quadrants (1, 2, 3, and 4 in Figure 3) of the scanner/scale's weigh platter. Verify that a reading of between 9.99 and 10.01 lb registers under load and that the display returns to 0.00 between each load.	1. Place and remove, in succession, a 10-pound load on the center of each of the four quadrants: 1, 2, 3, and 4, (as shown in Figure 3) of the scanner/scale's weigh platter. Verify that a reading of between 9.995 and 10.005 lb. registers, under load, in each quadrant tested. Check that the display returns to 0.00 between each load.
2. After verifying the accuracy of each quadrant of the weighing surface, remove all weight from the scale. This completes the Shift Test.	2. After verifying the accuracy of each quadrant of the weighing surface, remove all weight from the scale. This completes the Shift Test.

Increasing-Load Test (Single Interval Phase 2/Dual Interval Phase 3)

After completing the Shift Test, you must complete the Increasing Load Test using 20.0, 25.0 and 30.0 pounds of weight.



NOTE: The upper limit of the scale is configurable according to the POS interface type and may not necessarily be set at 30 pounds, which is the standard setting. For this test, continue to place weights in five pound increments only up to the upper weight limit set for your scale.

SINGLE INTERVAL	DUAL INTERVAL
After completing the Shift Test, you must complete the Increasing Load Test using 20.0, 25.0 and 30.0 pounds of weight.	After completing the Shift Test, you must complete the Increasing Load Test using 20.0, 25.0 and 30.0 pounds of weight.
1. With the scale starting at zero, place 20.0 pounds in the center of the weighing surface and check that the display reads between 19.99 and 20.01 lb.	1. With the scale starting at zero, place 20.0 pounds in the center of the weighing surface and check that the display reads between 19.99 and 20.01 lb.
2. Place an additional 5 pounds in the center of the weighing surface, increasing the load to 25.0 pounds and check that the display reads between 24.99 and 25.01 lb.	2. Place an additional 5 pounds (25 pounds total) in the center of the weighing surface. Check that the display reads between 24.99 and 25.01 lb.
3. Place an additional 5 pounds in the center of the weighing surface increasing the load to 30.0 pounds and check that the display reads between 29.99 and 30.01 lb.	3. Place an additional 5 pounds in the center of the weighing surface increasing the load to 30.0 pounds and check that the display reads between 29.99 and 30.01 lb.
4. Remove the weights and verify that the display reads 0.00.	4. Remove the weights and verify that the display reads 0.000.
5. You have completed the Increasing-Load Test (Phase 2)	5. You have completed the Increasing-Load Test (Phase 3).

Blanking Test

This test ensures that the scanner/scale will indicate its weighing capability has been exceeded if a weight greater than 0.05 pounds over its maximum upper weight is placed upon the unit.

1. Place weights that total the upper weight limit plus 0.051 pounds on the scale. For example: If the upper limit is set at 30 pounds, place weights totaling 30.051 pounds on the scale.
2. Verify that the display shows a dash and three hyphens (_ - -). This is the over-weight indication.



NOTE: The scanner/scale may blank (show an underscore and three hyphens) at any weight greater than its upper weight limit, but must blank when the upper weight limit plus 0.051 pounds are set upon the weighing surface.

Decreasing-Load Test

This test ensures that the scanner/scale responds properly when a heavy object is followed by a significantly smaller object.



NOTE: If the upper weight limit for your scale is set to other than 30 pounds, begin by placing weight equaling your upper limit setting.

SINGLE INTERVAL	DUAL INTERVAL
1. Place a 30.0-pound load on the scale in the center of the weighing surface and verify that the display shows between 29.99 and 30.01 pounds.	1. Place a 30.0-pound load on the scale in the center of the weighing surface and verify that the display shows between 29.99 and 30.01 pounds.
2. Remove weights to leave 20 pounds on the scale. Check that the display shows between 19.99 and 20.01.	2. Remove enough weights to leave 20 pounds on the scale. Check that the display shows between 19.99 and 20.01.
3. Remove another 15.0 pounds from the scale and check that the scale reads 5.00 lb.	3. Remove 5.0 pounds and verify the display reads between 4.995 and 5.01 pounds.
4. You have completed the Decreasing Load Test.	4. Remove 10.0 pounds and verify the display reads between 4.95 and 5.005 pounds.
	5. Remove another 2.5 pounds from the scale and check that the scale reads between 2.495 and 2.505 pounds
	6. You have completed the Decreasing Load Test.

Return to Zero Test

This test ensures that, after all other tests have been completed successfully, the scanner/scale returns to zero. Remove all weights from the scale and verify that the scale reads 0.00 lb.

After completing this test, close the calibration access cover and seal per local Weights and Measures requirements. This final step must agree with the legal requirements of your state or local government.

You have completed the calibration and verification process for weighing in pounds.

If the scanner/scale passes all these tests:

1. Remove the weigh platter, install the calibration switch cover and install a seal (if required).
2. Reinstall the weigh platter.

If the scale fails any of these tests, turn to [Chapter 4, Problem Isolation](#) and follow the troubleshooting procedures for Scale Failures.

CALIBRATION VERIFICATION (KILOGRAMS)

Once you have completed the calibration sequence, you may be required to perform these step-by-step verification procedures following the *National Institute of Standards and Technology Handbook-44* guidelines for grocery scale installations. You may be required by state or local law to have these procedures performed by a certified technician or verified by a proper official.

These calibration verification procedures cover five (5) different tests:

- Increasing-Load Test• Decreasing-Load Test
- Shift Test• Return to Zero Text
- Blanking Test



NOTE: If the scale fails any of these tests, go to the topic [Scale Error Reporting](#) in Chapter 4, Problem Isolation, of this manual.

Increasing-Load Test (Phase 1)

SINGLE INTERVAL	DUAL INTERVAL
This test checks Scale operation for increasing loads from 0.100 kg and 7.50 kg.	This test checks scale operation for increasing loads from 0.050 kg and 3 kg.
1. Check that the display reads 0.000 kg when at rest with nothing on the weighing surface. (The Yellow LED is steadily lit).	1. Check that the display reads 0.000 kg when at rest with nothing on the weighing surface. (The Zero Status LED is on steady).
2. Place a 100 gram weight on the center of the weighing surface and check that the display reads 0.100 kg.	2. Place a 50 gram weight on the center of the weighing surface and check that the Remote Display reads 0.050 kg.
3. Place an additional 200 grams on the center of the weighing surface and check that the display reads 0.300 kg.	3. Place an additional 100 grams on the center of the weighing surface (.0300 kg, total) and check that the Remote Display reads 0.150 kg.
4. Place an additional 200 grams on the center of the weighing surface and check that the display reads 0.500 kg.	4. Place an additional 100 grams on the center of the weighing surface and check that the Remote Display reads 0.250 kg.
5. Place an additional 100 grams on the center of the weighing surface and check that the display reads 0.600 kg.	5. Place an additional 50 grams on the center of the weighing surface and check that the display reads .300 kg.
6. Place an additional 100 grams on the center of the weighing surface and check that the display reads 0.700 kg.	6. Place an additional 50 grams on the center of the weighing surface and check that the display reads .350 kg.
7. Place an additional 100 grams on the center of the weighing surface and check that the display reads 0.800 kg.	7. Place an additional 50 grams on the center of the weighing surface and check that the display reads .400 kg.
8. Place an additional 200 grams on the center of the weighing surface and check that the display reads 1.000 kg.	8. Place an additional 100 grams on the center of the weighing surface and check that the display reads .500 kg.
9. Increase the weight on the scale to 7.50 kg on the center of the weighing surface and check that the display reads between 7.495 and 7.505 kg.	9. Increase the weight on the center of the weighing surface to 3.000 kg and check that the display reads between 2.998 and 3.002 kg.
10. Remove the weights and verify that the display reads 0.000 kg. You have completed the Increasing-Load Test (Phase 1).	10. Remove the weights and verify that the display reads 0.000 kg. You have completed the Increasing-Load Test (Phase 1).

Shift Test Metric (2 Kilogram Dual Interval ONLY)

The Shift Test checks to ensure that items placed anywhere on the weighing surface of the scanner/scale are weighed properly. Refer to [Figure 4](#) when performing this test.

DUAL INTERVAL	
1.	Place and remove, in succession, a 2 kilogram load on the center of each of the four quadrants: 2, 3, 4, and 5, and in the center (1) of the scanner/scale's weighing platform (see Figure 4). Verify that the Remote Display shows a reading of between 1.998 and 2.002 kg for each quadrant/center test. Check that the display returns to 0.000 between each load.
2.	After verifying the accuracy of each quadrant and the center of the weighing surface, remove all weight from the scale. This completes the Shift Test Metric (2 Kilogram).

Figure 4. Metric Shift Test

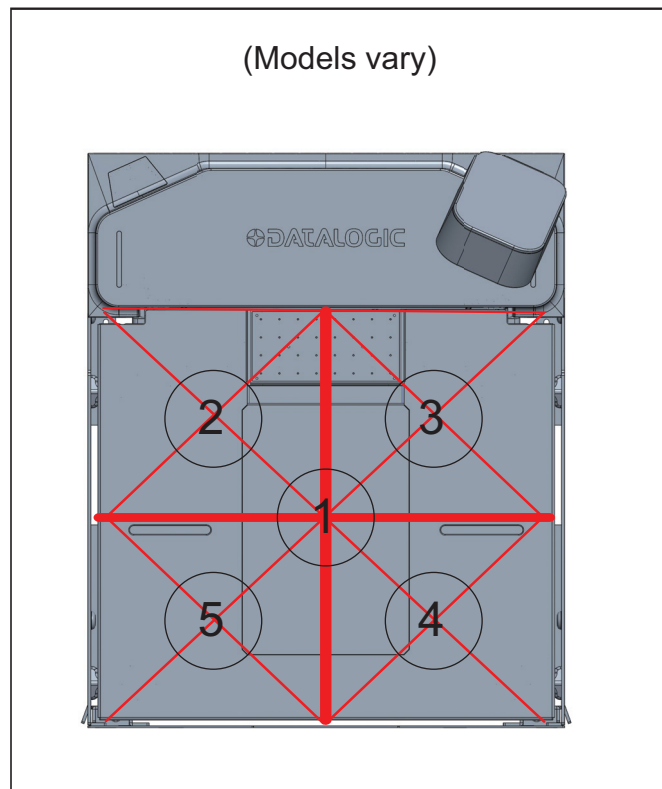

Increasing Load Test (Phase 2 Dual Interval ONLY)

After completing the Shift Test, you must complete the Increasing Load Test using 4, 5 and 6 kilograms of weight.



NOTE: The upper limit of the scale is configurable according to POS interface type and may not necessarily be set at 15 kilograms, which is the standard setting. For this test, continue to place weights in 1 kilogram increments only to the upper weight limit set for your scale.

DUAL INTERVAL
1. Place 4 kilograms in the center of the weighing surface and check that the Remote Display reads between 3.998 kg and 4.002 kg.
2. Place an additional 1 kilogram in the center of the weighing surface and check that the display reads between 4.998 kg and 5.002 kg.
3. Place an additional 1 kilogram in the center of the weighing surface and check that the display reads between 5.998 kg and 6.005 kg.
4. Increase the weight on the center of the weighing surface to 7.50 kg and check that the display reads between 7.495 and 7.505 kg.
5. Remove the weights and verify that the display reads 0.000 kg. You have completed the Increasing-Load Test.

Shift Test — Metric (5 Kilograms)

The Shift Test checks to ensure that items placed anywhere on the weighing surface of the scanner/scale are weighed properly. Refer to [Figure 4](#) when performing this test.

SINGLE INTERVAL	DUAL INTERVAL
1. Place and remove in succession, a 5.0 kilogram load on the center of each of the four quadrants and in the center of the scanner/scale’s weighing platform. Verify that the display shows a reading of between 4.995 and 5.005 kg for each quadrant/center test and that the display returns to 0.000 between each load.	1. Place and remove, in succession, a 5.0 kilogram load on the center of each of the four quadrants and in the center of the scanner/scale’s weighing platform. Verify that the Remote Display shows a reading of between 4.998 and 5.002 kg for each quadrant/center test. Check that the display returns to 0.000 between each load.
2. After verifying the accuracy of each quadrant and the center of the weighing surface, remove all weight from the scale. This completes the Shift Test — Metric (5 Kilograms).	2. After verifying the accuracy of each quadrant and the center of the weighing surface, remove all weight from the scale. This completes the Shift Test — Metric (5 Kilograms).

Increasing-Load Test (Single Interval Phase 2/Dual Interval Phase 3)



NOTE: The upper limit of the scale is configurable according to POS interface type and may not necessarily be set at 15 kilograms, which is the standard setting. For this test, continue to place weights in 2.50 kilograms increments only to the upper weight limit set for your scale.

SINGLE INTERVAL	DUAL INTERVAL
After completing the Shift Test, you must complete the Increasing Load Test using 10.00, 12.50 and 15 kilograms of weight.	After completing the Shift Test, you must complete the Increasing Load Test using 10.00, 12.50 and 15 kilograms of weight.
1. Place 10.00 kilograms in the center of the weighing surface and check that the display reads between 9.995 kg and 10.005 kg.	1. Place 10.00 kilograms in the center of the weighing surface and check that the Remote Display reads between 9.995 kg and 10.005 kg.
2. Place an additional 2.50 kilograms in the center of the weighing surface and check that the display reads between 12.495 kg and 12.505 kg.	2. Place an additional 2.50 kilograms in the center of the weighing surface and check that the display reads between 12.495 kg and 12.505 kg.
3. Place an additional 2.50 kilograms in the center of the weighing surface and check that the display reads between 14.995 kg and 15.005 kg.	3. Place an additional 2.50 kilograms in the center of the weighing surface and check that the display reads between 14.995 kg and 15.005 kg.
4. Remove the weights and verify that the display reads 0.000 kg.	4. Remove the weights and verify that the display reads 0.000 kg.
5. You have completed Phase 2 of the increasing load test.	5. You have completed Phase 3 of the Increasing Load Test.

Blanking Test

This test ensures that the scanner/scale will indicate its weighing capability has been exceeded if a weight greater than 0.82 kilograms over its maximum upper weight limit is placed upon the scale platter.

1. Place weights that total the upper limit plus 0.82 kilograms on the weigh platter. For example: If the upper limit is set at 15 kilograms, place weight totaling 15.82 kilograms.
2. Verify that the display shows a dash and three hyphens (_---). This is the over-weight indication.



NOTE: The scanner/scale may blank (show an underscore and three hyphens) at any weight greater than its upper limit plus 0.82 kilograms are set upon the weighing surface.

Decreasing-Load Test

This test ensures that the scanner/scale responds properly when a heavy object is followed by a significantly smaller object.



NOTE: If the upper weight limit for your scale is not set at 15 kilograms, begin by placing weight equaling your upper limit plus 0.8 kilograms.

SINGLE INTERVAL	DUAL INTERVAL
1. Place weights in the center of the weighing surface that total 15.8 kilograms.	1. Place weights in the center of the weighing surface that total 15.8 kilograms.
2. Remove weights to leave 10 kilograms on the scale and verify that the display shows between 9.995 and 10.005 kilograms.	2. Remove weights to leave 10 kilograms on the scale and verify that the display shows between 9.995 and 10.005 kilograms.
3. Remove an additional 7.50 kilograms from the scale and check that the scale reads 2.500 kg.	3. Remove an additional 4 kilograms from the scale and check that the scale reads between 5.998 and 6.005 kg.
4. You have completed the Decreasing Load Test.	4. Remove an additional 2 kilograms from the scale and check that the scale reads between 3.998 and 4.002 kg.
	5. Remove an additional 3 kilograms from the scale and check that the scale reads 1 kg.
	6. You have completed the Decreasing Load Test.

Return to Zero Test

This test ensures that, after all other tests have been completed successfully, the scanner/scale returns to zero. Without any weight on the weigh platter, verify that the scale reads 0.000 kg.

You have completed the calibration and verification process for weighing in kilograms.

If the scanner/scale passes all these tests:

1. Remove the weigh platter, install the calibration switch cover and install a seal (if required).
2. Reinstall the weigh platter.

If the scale fails any of these tests, turn to [Chapter 4, Problem Isolation](#) and follow the troubleshooting procedures for Scale Failures.

CHAPTER 6

PROGRAMMING

INTRODUCTION TO LABEL PROGRAMMING

The programming bar code labels contained in this manual will allow you to customize and configure features and settings for your scanner (scanner/scale). To ensure full compatibility and proper function, use only the programming bar codes in this manual and other product-specific publications to program scanner features.

This manual has been developed to make it quick and easy for users of all levels to find the information needed to understand and configure features. The following descriptions will help you to determine where to go from here.

UNDERSTANDING THE BASICS

If you have little or no prior experience with programming using bar code labels, you should review the first few pages of this section to familiarize yourself with the basics of scanner programming before performing any changes to your configuration.

Using a Bar Code Mask

The programming bar codes in this manual have been placed as multiples per page. In order to present them only one at a time to the scanner, a bar code mask is provided on the opposite side of this page.

Going Green

Thank you for using the bar code mask on the opposite side of this page. This manual has been formatted to minimize the quantity of pages needed to provide all of the programming bar codes available for this product.



Bar Code Mask

Cut a hole in this page and remove it from the manual as indicated to create a sleeve through which bar codes (starting in the following section) can be individually viewed and scanned. It is important that only one bar code at a time be presented to the scanner.

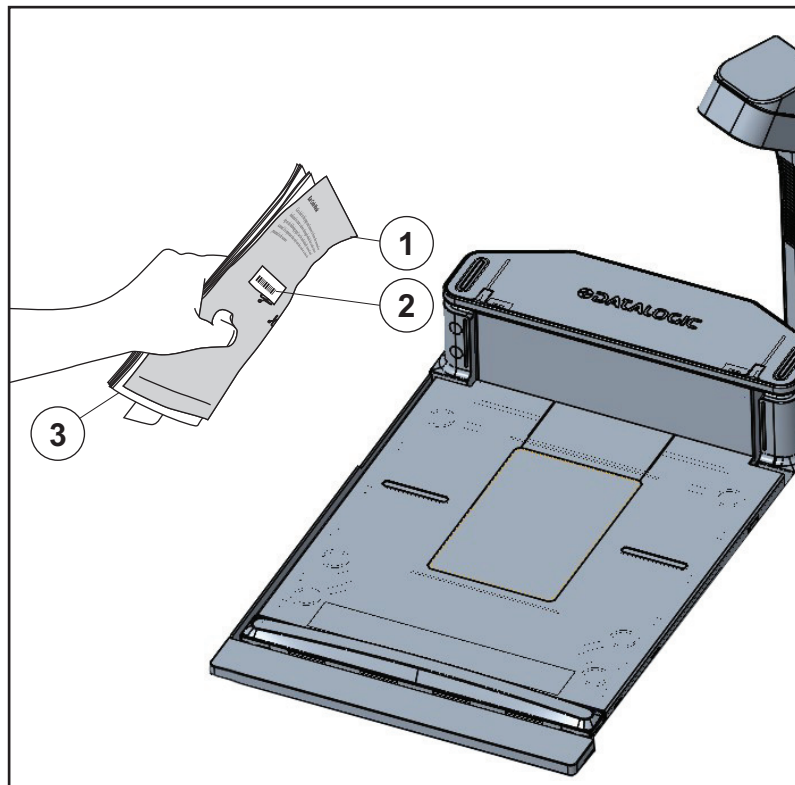
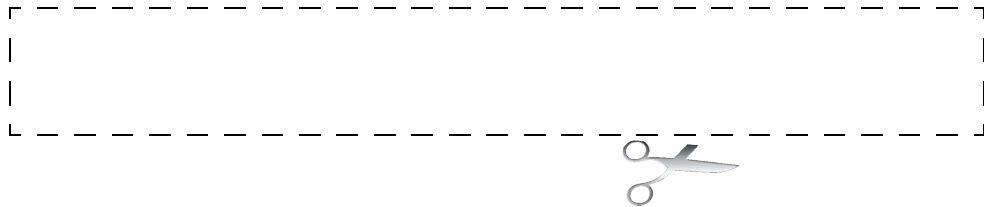

- 1. Bar Code Mask Sheet
- 2. Bar Code
- 3. Manual (folded)

INTEGRATING THE SCANNER WITH YOUR HOST SYSTEM

Your scanner **MUST** be equipped with the correct hardware (interface board, cable, etc.) to properly communicate with your host system. Contact your dealer for information if you have questions about your scanner's hardware compatibility.

You may also want to contact the dealer or your system administrator if you have no record of how your scanner was pre-programmed at the factory. Scanners are typically programmed with the default settings for specific interface types (see Appendix F, [Factory Defaults](#) for more information); however, your scanner may have been custom configured with settings that are unique to your company or application.

Once you know the scanner's current settings, you can determine what changes will be required to allow communication with your host system and/or optional features you choose to modify to customize your installation. After recording the modifications needed, finish reading this section, then turn to the appropriate page and follow the instructions to program the scanner.

When all scanner features are programmed to your satisfaction, the scanner is ready to be placed into operation.

CUSTOMIZING YOUR SCANNER'S OPERATION

Most scanner programming falls within four general categories:

General Scanner and Scale Features: are features common to all interface types. Examples include beeper adjustments such as volume and length, read verification settings, etc.

EAS Features: control the settings for interfacing with the (optional) EAS device.

Interface Related Features: are the mandatory settings necessary to allow communication with your host terminal. Examples of these settings are: RS-232 baud rate and parity.



CAUTION: It is possible, via programming bar codes, to change the interface type (for example: from RS-232 to IBM Port 17). Great care should be taken to select the correct interface type, since you can cause damage to the scanner and/or POS terminal by attempting to change to an incompatible interface. **ALWAYS** make interface selections with the host cable **DISCONNECTED**.



NOTE: Ensure that your planned modifications are compatible with the current interface. For example, baud rate selections are only valid in the RS-232 interface. The scanner will sound an error tone when scanning programming labels for features invalid to the current interface group.

Symbology Programming: gives the scanner the capability to autodiscriminate as few as one, and as many as all available symbologies. For optimal scanner performance enable only those symbologies required. Additionally the scanner may be programmed with the standard options available for the various symbologies, such as check digit, minimum label length, fixed and variable length bar codes, etc.

If you experience difficulties, have questions or require additional information, contact your local distributor, or call your dealer or sales representative.

PROGRAMMING OVERVIEW

The scanner's programmable feature settings can be modified to accommodate your system's unique requirements. These settings can be communicated to the scanner in one of two ways:

1. Commands can be sent directly from the host. A limited set of host commands are available. Refer to Appendix E for more details or contact Tech Support.
2. Programming bar code labels can also be used to modify the scanner's programmable settings. This manual provides the bar code labels and instructions necessary to configure the scanner's features and options.



NOTE: When you program the scanner using any of the methods above, the scanner will store the changes until reprogrammed or returned to factory defaults.

3. Alternatively, a configuration utility called "Scanalyzer" can be used to program the scanner.

Programming via Handheld Device

The scanner can also accept programming via its USB ports using a handheld scanning device. Eligible handheld devices must have the ability to transmit the C128 1D and Data Matrix 2D programming bar codes presented in this manual. Several Datalogic™ handheld models support this functionality. Handheld data format requirements (baud rate, parity, etc.) are presented in Appendix G of this manual.

What Is Programming Mode?

Programming Mode is a state in which the scanner must be placed in order to accept commands via programming bar code labels. When programming using the bar code labels in this manual, the scanner is typically placed in Programming Mode by scanning the Enter/Exit Programming Mode label.

While in the Programming Mode, the scanner only recognizes the special programming bar codes contained in this programming guide. See Appendix A for information about scanner indications while in the Programming Mode.

Entering and Exiting Programming Mode.

When needed, an Enter/Exit Programming Mode bar code is available at the top of each programming page.



NOTE: Your scanner will read the 2D programming bar codes in this manual while in Programming Mode, regardless of whether 2D reading capability has been enabled as an option.

Programming Session

A typical programming session is conducted as follows:

1. Scan the Enter/Exit Programming Mode bar code to place the scanner in Programming Mode. Depending upon its current programming, the scanner may emit a beep or beeps, indicating it has read the bar code and the green LED will flash on and off slowly while the scanner remains in Programming Mode. Normal scanning functions are disabled.
2. Scan the programming bar code(s) that is (are) specially encoded to make the desired changes. With few exceptions¹, the scanner will emit a triple beep each time you scan a valid programming bar code.



NOTE: In the following sections, text shown with a green star indicates a factory default value.

★ This is an example of a default value.



NOTE: Not all features are available for all interfaces and the scanner will sound an error tone when scanning programming bar codes for features invalid to the current interface. Only features supported by the currently active interface will be implemented.



NOTE: If a bar code is scanned that changes the scanner's interface, all previous configuration items scanned in the programming session are lost.

Additionally, when programming a feature requiring you to scan single digits to set a multi-digit number, such as Minimum Label Length, scanning the Enter/Exit Programming Mode bar code (or any item tag/item value bar code) before completing all input will result in an error tone and cause the scanner to exit Programming Mode. Under these circumstances, the current feature you were trying to set is thrown out; any previous bar codes scanned during the session will take effect.



NOTE: It is recommended that programming sessions be limited to one feature at a time. Should you make a mistake in the programming sequence, it can be difficult to discover where an error has been made if several features are programmed at once. Additionally, it can be confusing to determine which features may or may not have been successfully set following such a session.

3. Scan the Enter/Exit Programming Mode bar code to save any new settings and exit Programming Mode. The scanner will sound a beep and reset upon exiting Programming Mode, and the green LED will return to its usual state (on steady or off).

1. Some features, such as Minimum Label Length, require you to select the label's length by scanning a series of single-digit bar codes. A single 'good read' beep is sounded when scanning these single digits in Programming Mode. Only the final required digit in the sequence will produce a triple beep when scanned, indicating a successfully programmed feature.

The scanner will exit Programming Mode under the following conditions:

- the programming sequence has been completed or the **Enter/Exit Programming Mode** bar code is scanned.
 - five minutes have passed without scanning activity. Any data programmed during the current session is ignored, and the scanner will reset and revert to its condition previous to initiating the exited session.
 - power is disconnected. Disconnecting power during Programming Mode, before scanning the **Enter/Exit Programming Mode** bar code, will cause all new settings to be ignored¹. On power-up, the scanner will return to previous settings.
4. Maintain a good record of all changes made to ensure that you know if the original factory settings have been changed.

Programming Sequence

To modify a scanner feature (item), the programming bar codes contained in this manual must be scanned in a given sequence depending upon the feature being programmed (as shown in Table 1). There are three possible programming sequences:



NOTE: If the scanner's interface type must be changed, always be sure that interface configuration is the FIRST item scanned during a programming session. (Selecting an interface type resets ALL other configuration items to the stored values for that interface type.)

A. Programming sample A (the most commonly used format) demonstrates how three bar codes are scanned in sequence to do the following:

1. Place the scanner in Programming Mode (**Enter/Exit Programming Mode** bar code).
2. Scan the Item Tag that will enable the new feature.
3. End the programming session and reset the scanner (**Enter/Exit Programming Mode** bar code).

B. Sample B provides an example of a programming feature requiring the entry of a range value. Like sample A, the scanner is placed in Programming Mode and an Item Tag¹ is scanned. Then, a value must be entered before ending the programming session. In the example, three digits must be scanned from the number pad in Appendix C. This type of format, requiring several bar codes, is necessary to allow flexible programming for item values with larger numeric ranges.













NOTE: Unless otherwise directed, item value settings (for example, label lengths) are entered as decimal numbers. Only enter values as hexadecimal when instructed to do so.

C. The programming sequence shown in example C requires scanning of a single, extended length bar code. This special programming bar code contains all the data necessary to enter Programming Mode, set the Item Tag² and Item Value, and exit Programming Mode (all in one step).

1. Exception: If an interface bar code had been read while in Programming Mode, the scanner will operate on the default settings for the new interface.
2. An "Item Tag" is a term used to describe an assigned number, which is encoded in a programming bar code, that toggles (selects, enables, disables, etc.) a specific programming feature

Table 1. Programming Sequence

	SET	ITEM TAG	ITEM VALUE	END/RESET
A	1	2		3
	Enter/Exit Programming Mode 	ENABLE NEW FEATURE 		Enter/Exit Programming Mode 
B	1	2	3 4 5	6
	Enter/Exit Programming Mode 	ENABLE NEW FEATURE USING THE FOLLOWING SETTINGS... 	0  0  8 	Enter/Exit Programming Mode 
C	1			
	ONE BAR CODE CONTAINS ENTER + ITEM TAG + ITEM VALUE + EXIT 			

LED and Beeper Indicators

The scanner provides a set of indicators that verify/announce the various scanner functions. See Appendix A for more details.

If You Make a Mistake...

If, during a programming session, you find that you are unsure of the scanner's settings or wish to reset the scanner's configuration, use the Return to Factory Settings label below to return the scanner's configuration to the factory settings. Scanning this label will also reset any changes made during previous programming sessions.

Return to Factory Settings

Scan the bar code below to return the scanner to the default settings configured at the factory for the currently active interface. This bar code is typically used to return the scanner to a "known" operating state when the present programming status is not known, faulty, or suspect.



CAUTION: Use this bar code with caution, since it will reset ALL features that may have been programmed since the scanner's installation.



NOTE: DO NOT scan the Enter/Exit Programming Mode bar code before and after scanning this bar code.

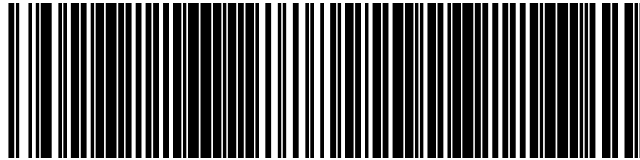

RETURN TO FACTORY SETTINGS

Test Mode

Use this feature to place the scanner into a testing, or “demo” mode. This special mode disables the scanner interface, meaning that bar code data is not sent out to the host via the scanner interface. This allows the bar code to be scanned continuously without requiring a response from the POS terminal.

Enable Test Mode: The scanner will scan labels and beep without sending data.

Disable Test Mode: The scanner will return to the original configuration before Test Mode was entered.



NOTE: DO NOT scan the Enter/Exit Programming Mode bar code before and after scanning the bar codes on this page.

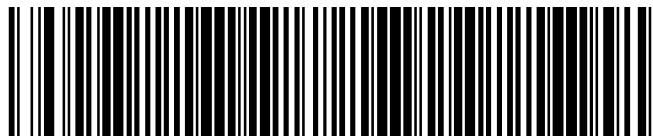

TEST MODE = DISABLE

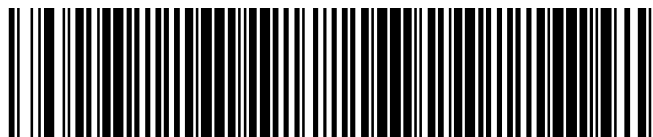

TEST MODE = ENAB

NOTES

GENERAL SCANNER AND SCALE FEATURES

SECTION CONTENTS	
SCANNING FEATURES starting on page 92	
<ul style="list-style-type: none"> • 1D Double Read Timeout • 2D Double Read Timeout • Digital Watermark (DWM) Features <ul style="list-style-type: none"> - Digital Watermark (DWM) Enable - Digitally Watermarked (DWM) Double Read Timeout - Digital Watermark (DWM) Operation Mode - Digital Watermark (DWM) Data Format • Digital Watermark (DWM) 2D Time 	<ul style="list-style-type: none"> • Label Gone Timeout • Sleep Mode Timer • 1D Inverse Read Control • 2D Inverse Read Control • Illumination Control • 2D Contrast Improvement • 1D VL Shared Decode Timeout
LED AND BEEPER INDICATIONS starting on page 105	
<ul style="list-style-type: none"> • Good Read LED Idle State • Scanner Control Button Options • Power-up Tone Control • Good Read Beep Control • Good Read Beep Frequency 	<ul style="list-style-type: none"> • Good Read Beep Length • Good Read Beep Volume • Good Read When to Indicate • Scale Zero Button and Scale Indicator LED
SCALE SENTRY starting on page 114	
<ul style="list-style-type: none"> • Scale Sentry Block Weight Transmission • Scale Sentry Override Button • Scale Sentry Mode 	<ul style="list-style-type: none"> • Scale Sentry GRI Enable • Scale Sentry Adaptive Scale Indication State • Adaptive Scale LED Option
SCALE ENABLE starting on page 121	
<ul style="list-style-type: none"> • Scale Diagnostics Mode • Scale Stale Weight Timeout • Scale Enforced Zero Return • Scale Interface Type • Scale Baud Rate 	<ul style="list-style-type: none"> • Scale Interface Settings • Scale Interface Options • ICL Scale Interface DC1 Character Delay • Scale Calibration Notification • Scale Intercharacter Delay
REMOTE DISPLAY — ENABLE/DISABLE starting on page 136	
AUXILIARY USB MODE starting on page 137	
<ul style="list-style-type: none"> • Auxiliary USB Mode 	<ul style="list-style-type: none"> • USB Device Port Location
PIR / CT starting on page 139	



SCANNING FEATURES

1D Double Read Timeout

The 1D Double Read Timeout feature specifies the minimum allowable time which must pass before reading the same 1D label again (e.g. two identical items in succession).

To set the Double Read Timeout:

1. Scan the Enter/Exit Programming Mode bar code.
2. Scan your selection from the bar codes below. You'll need to cover any unused bar codes on this and the facing page to ensure that the scanner reads only the bar code you intend to scan.
3. Complete the programming sequence by scanning the Enter/Exit Programming Mode bar code.



NOTE: If the incidence of multiple reads is not acceptable, increase the Double Read Timeout setting to a higher value.



★ 1D Double Read Timeout = 300ms



1D Double Read Timeout = 400ms



1D Double Read Timeout = 600ms



1D Double Read Timeout = 800ms

2D Double Read Timeout

The 2D Double Read Timeout feature specifies the minimum allowable time which must pass before reading the same 2D label again (e.g. two identical items in succession).

To set this feature:

1. Scan the Enter/Exit Programming Mode bar code.
2. Scan your selection from the bar codes below. You'll need to cover any unused bar codes on this and the facing page to ensure that the scanner reads only the bar code you intend to scan.
3. Complete the programming sequence by scanning the Enter/Exit Programming Mode bar code.



NOTE: If the incidence of multiple reads is not acceptable, increase the Timeout setting to a higher value.



2D Double Read Timeout = 300ms



2D Double Read Timeout = 400ms



2D Double Read Timeout = 600ms



★ 2D Double Read Timeout = 700ms



2D Double Read Timeout = 800ms

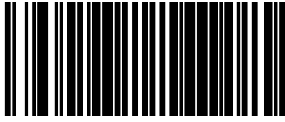

DIGITAL WATERMARK (DWM) FEATURES

Digital Watermark (DWM) Enable

Enables/Disables the ability of the scanner to decode Digital Watermarks.

To set this feature:

1. Scan the Enter/Exit Programming Mode bar code.
2. Scan your selection from the bar codes below. You'll need to cover any unused bar codes on this and the facing page to ensure that the scanner reads only the bar code you intend to scan.
3. Complete the programming sequence by scanning the Enter/Exit Programming Mode bar code.



NOTE: The Digital Watermark feature must be enabled for decode functionality.



Digital Watermark (DWM) = Disable



★ Digital Watermark (DWM) = Enable

Digitally Watermarked (DWM) Double Read Timeout

Specifies the minimum allowable time which must pass before reading the same Digitally Watermarked (DWM) label again (e.g. two identical items in succession).

To set this feature:

1. Scan the Enter/Exit Programming Mode bar code.
2. Scan your selection from the bar codes below. You'll need to cover any unused bar codes on this and the facing page to ensure that the scanner reads only the bar code you intend to scan.

Complete the programming sequence by scanning the Enter/Exit Programming Mode bar code.



NOTE: If the incidence of multiple reads is not acceptable, increase the Double Read Timeout setting to a higher value.



DWM Double Read Timeout = 0.3 Seconds



DWM Double Read Timeout = 0.4 Seconds



★ DWM Double Read Timeout = 0.5 Seconds



DWM Double Read Timeout = 0.7 Seconds



DWM Double Read Timeout = 1 Second



Digital Watermark (DWM) Operation Mode

Selects processing engine allocation for the watermark reader. Choices are:

- Dedicated - allocate a decode engine for exclusive use
- Shared with 2D - share the 2D decode engine

1. Scan the Enter/Exit Programming Mode bar code.
2. Scan your selection from the bar codes below. You'll need to cover any unused bar codes on this and the facing page to ensure that the scanner reads only the bar code you intend to scan.
3. Complete the programming sequence by scanning the Enter/Exit Programming Mode bar code.



NOTE: The Digital Watermark feature must be enabled for decode functionality.



★ Digital Watermark (DWM) Operation Mode = Dedicated



Digital Watermark (DWM) Operation Mode = Shared with 2D

Digital Watermark (DWM) Data Format

Selects the format for the watermark data. Choices are:

- Compatibility mode
- Databar Omnidirectional
- Native

1. Scan the Enter/Exit Programming Mode bar code.
2. Scan your selection from the bar codes below. You'll need to cover any unused bar codes on this and the facing page to ensure that the scanner reads only the bar code you intend to scan.
3. Complete the programming sequence by scanning the Enter/Exit Programming Mode bar code.



NOTE: The Digital Watermark feature must be enabled for decode functionality.



★ Digital Watermark (DWM) Data Format = Compatibility mode



Digital Watermark (DWM) Data Format =
Databar Omnidirectional mode



Digital Watermark (DWM) Data Format = Native mode



Digital Watermark (DWM) 2D Time

This feature specified the maximum time for 2D digital watermark decoder to process an image

1. Scan the Enter/Exit Programming Mode bar code.
2. Scan your selection from the bar codes below. You'll need to cover any unused bar codes on this and the facing page to ensure that the scanner reads only the bar code you intend to scan.
3. Complete the programming sequence by scanning the Enter/Exit Programming Mode bar code.



NOTE: The Digital Watermark feature must be enabled for decode functionality.



★ Digital Watermark Decoder Timeout = .04 seconds



Digital Watermark Decoder Timeout = .1 seconds



Digital Watermark Decoder Timeout = .25 seconds



Digital Watermark Decoder Timeout = .5 seconds

Label Gone Timeout

Specifies the amount of time in cycles (one cycle = 25ms) that data segments are stored by the software before being discarded if a label has not been successfully decoded during the current “label in volume session,” which is defined as the time between when the label gone time is first started until the label gone timer expires.



NOTE: This only applies to UPC/EAN labels when segment assembly is enabled.

1. Scan the Enter/Exit Programming Mode bar code.
2. Scan your selection from the bar codes below. You’ll need to cover any unused bar codes on this and the facing page to ensure that the scanner reads only the bar code you intend to scan.
3. Complete the programming sequence by scanning the Enter/Exit Programming Mode bar code.



★ Label Gone Timeout = 0.4 Seconds



Label Gone Timeout = 0.6 Seconds



Label Gone Timeout = 0.8 Seconds



Label Gone Timeout = 1.2 Seconds



Label Gone Timeout = 1.6 Seconds



Sleep Mode Timer

This feature specifies the amount of time of inactivity (with no label reads) before the scanner enters sleep mode.

To set this feature:

1. Scan the Enter/Exit Programming Mode bar code.
2. Scan the bar code, [Set Sleep Mode Timer](#) below. You'll need to cover any unused bar codes on this and the facing page to ensure that the scanner reads only the bar code you intend to scan.
3. Scan the appropriate digits from the [Keypad](#) in [Appendix C](#) that represent the desired time interval. The selectable range is 000-255 in 15 second increments. Pad all numbers with leading zeros to yield a three-digit entry (000-255).
4. Scan the Enter/Exit Programming Mode bar code to exit Programming Mode.



Set Sleep Mode Timer

★ Default setting for this feature is: 5 minutes

1D Inverse Read Control

This configuration item is used to toggle inverted label reading for 1D bar codes, for example, a label printed as white on black as opposed to black on white.

To set this feature:

1. Scan the Enter/Exit Programming Mode bar code.
2. Scan your selection from the bar codes below. You'll need to cover any unused bar codes on this and the facing page to ensure that the scanner reads only the bar code you intend to scan.
3. Complete the programming sequence by scanning the Enter/Exit Programming Mode bar code.



★ 1D Inverse Read Control = Disable



1D Inverse Read Control = Enable



2D Inverse Read Control

This configuration item is used to toggle inverted label reading for 2D bar codes, for example, a label printed as white on black as opposed to black on white. To set this feature:

1. Scan the Enter/Exit Programming Mode bar code.
2. Scan your selection from the bar codes below. You'll need to cover any unused bar codes on this and the facing page to ensure that the scanner reads only the bar code you intend to scan.
3. Complete the programming sequence by scanning the Enter/Exit Programming Mode bar code.



★ 2D Inverse Read Control = Disable



2D Inverse Read Control = Enable

Illumination Control

This feature allows illumination to be turned off when the scanner is disabled.

1. Scan the Enter/Exit Programming Mode bar code.
2. Scan your selection from the bar codes below:
Disable = Illumination remains on during the time the scanner is disabled.
Enable = Illumination turns off during the time the scanner is disabled.
3. Complete the programming sequence by scanning the Enter/Exit Programming Mode bar code.



★ Illumination Control = Disable



Illumination Control = Enable

2D Contrast Improvement

This feature enables / disables the scanner's ability to enhance the image contrast for scanned 2D symbologies.

To set this feature:

1. Scan the Enter/Exit Programming Mode bar code.
2. Scan your selection from the bar codes below. You'll need to cover any unused bar codes on this and the facing page to ensure that the scanner reads only the bar code you intend to scan.
3. Complete the programming sequence by scanning the Enter/Exit Programming Mode bar code.



★ 2D Contrast Improvement = Disable



2D Contrast Improvement = Enable



1D VL Shared Decode Timeout

This feature sets the 1D VL decoding timeout when the decode processor is dynamically shared with the 2D or Watermark decoders.

To set this feature:

1. Scan the Enter/Exit Programming Mode bar code.
2. Scan your selection from the bar codes below. You'll need to cover any unused bar codes on this and the facing page to ensure that the scanner reads only the bar code you intend to scan.
3. Complete the programming sequence by scanning the Enter/Exit Programming Mode bar code.



★ 1D VL Shared Decode Timeout = 0.015 seconds



1D VL Shared Decode Timeout = 0.025 seconds



1D VL Shared Decode Timeout = 0.05 seconds



1D VL Shared Decode Timeout = 0.1 seconds



1D VL Shared Decode Timeout = 0.2 seconds

LED AND BEEPER INDICATIONS

Good Read LED Idle State

This feature specifies the state of the green scanner LEDs when the scanner is idle and ready to read a label. Options are:

- Off
- On dim

To set the Scanner LEDs Idle State:

1. Scan the Enter/Exit Programming Mode bar code.
2. Scan your selection from the bar codes below. You'll need to cover any unused bar codes on this and the facing page to ensure that the scanner reads only the bar code you intend to scan.
3. Complete the programming sequence by scanning the Enter/Exit Programming Mode bar code.



Scanner LED Idle State = Off



★ Scanner LED Idle State = On Dim



Scanner Control Button Options

Configure the Scanner Control Button to one of the following modes of operation:

- Enable all functions: Volume, tone, diagnostics and reset.
- Enable only volume, tone and reset.
- Enable reset only.
- Disable all button functions

To set the desired Scanner Control Button Option:

1. Scan the Enter/Exit Programming Mode bar code.
2. Scan your selection from the bar codes below. You'll need to cover any unused bar codes on this and the facing page to ensure that the scanner reads only the bar code you intend to scan.
3. Complete the programming sequence by scanning the Enter/Exit Programming Mode bar code.



★ Scanner Control Button = Enable All Functions



Scanner Control Button = Enable Only Volume Tone and Reset



Scanner Control Button = Enable Reset Only



Scanner Control Button = Disable All Functions

Power-up Tone Control

Specifies the type of audible indication that is made when entering scanner-active mode on power-up. Choices are:

- No tone
- Play tone

To set the Power-up tone:

1. Scan the Enter/Exit Programming Mode bar code.
2. Scan your selection from the bar codes below. You'll need to cover any unused bar codes on this and the facing page to ensure that the scanner reads only the bar code you intend to scan.
3. Complete the programming sequence by scanning the Enter/Exit Programming Mode bar code.



Power-up Beep Control = No Tone



★ Power-up Beep Control = Play Tone



Good Read Beep Control

This feature enables/disables scanner beep upon successfully decoding of a label.

To set this feature:

1. Scan the Enter/Exit Programming Mode bar code.
2. Scan your selection from the bar codes below. You'll need to cover any unused bar codes on this and the facing page to ensure that the scanner reads only the bar code you intend to scan.
3. Complete the programming sequence by scanning the Enter/Exit Programming Mode bar code.



Good Read Beep Control = Disable



★ Good Read Beep Control = Enable

Good Read Beep Frequency

Adjusts the scanner's good read beep to sound at low, medium, or high frequency (controls the beeper's pitch/tone).

- Low
- Medium
- High

To set this feature:

1. Scan the Enter/Exit Programming Mode bar code.
2. Scan your selection from the bar codes below. You'll need to cover any unused bar codes on this and the facing page to ensure that the scanner reads only the bar code you intend to scan.
3. Complete the programming sequence by scanning the Enter/Exit Programming Mode bar code.



Good Read Beep Frequency = Low



★ Good Read Beep Frequency = Medium



Good Read Beep Frequency = High



Good Read Beep Length

Specifies the duration of a good read beep.

To set this feature:

1. Scan the Enter/Exit Programming Mode bar code.
2. Scan the bar code, [Set Good Read Beep Length](#). You'll need to cover any unused bar codes on this and the facing page to ensure that the scanner reads only the bar code you intend to scan.
3. Scan the appropriate digits from the keypad in [Appendix C](#) that represent the desired good read beep length setting. The selectable range is 1-255, which is the timeout in 10-millisecond increments. Times have a tolerance of +/-25%. Pad all single and double digit numbers with leading zeroes to yield a three-digit entry (001-255).
Examples:
001 = 10ms
005 = 50ms
040 = 400ms
250 = 2,500ms (2.5 seconds)
4. The scanner will automatically exit Programming Mode when the appropriate amount of digits have been scanned.



Set Good Read Beep Length

★ Default setting for this feature is:
008 - 80ms

Good Read Beep Volume

Selects the beeper volume upon a good read beep. There are five selectable volumes, with each volume increment adding approximately five decibels to the previous level:

- Low
- Medium Low
- Medium
- Medium High
- High

To set this feature:

1. Scan the Enter/Exit Programming Mode bar code.
2. Scan your selection from the bar codes below. You'll need to cover any unused bar codes on this and the facing page to ensure that the scanner reads only the bar code you intend to scan.
3. Complete the programming sequence by scanning the Enter/Exit Programming Mode bar code.



Good Read Beep Volume = Low



Good Read Beep Volume = Medium Low



Good Read Beep Volume = Medium



Good Read Beep Volume = Medium High



★ Good Read Beep Volume = High



Good Read When to Indicate

This feature specifies when the scanner will provide indication (beep and/or flash its green LEDs) upon successfully reading a bar code.

- Good Read = Indicate after decode¹
- Good Read = Indicate after transmit
- Good Read = Indicate after CTS goes inactive, then active²
- Good Read = Indicate after each output structure proofed³

1. Scan the Enter/Exit Programming Mode bar code.
2. Scan the desired mode bar code from those provided below You'll need to cover any unused bar codes on facing pages to ensure that the scanner reads only the bar code you intend to scan.
3. Complete the programming sequence by scanning the Enter/Exit Programming Mode bar code.



★ Good Read When to Indicate = After Decode



Good Read When to Indicate = After Transmit



Good Read When to Indicate = After CTS goes Inactive,
Then Active



Good Read When to Indicate = After Each Output
Structure Proofed

1. For scanner models having intelligent integrated EAS, label transmission (and hence the good read beep) is completed after the EAS logic executes.
2. The "Indicate after CTS goes inactive..." mode applies to RS-232 STD and RS-232 WN interfaces only. If set to this mode in other interfaces, "Indicate after decode" mode will be implemented.
3. When beeping after each output structure decoded, if there are multiple output structures, there is a delay after the beep has finished. This delay is equal to the [Good Read Beep Length](#).

Scale Zero Button and Scale Indicator LED

Here are the configurable options for the Scale Zero Button and Scale Indicator LED:

- Scale Zero Button and Scale Indicator LED active
- Scale Indicator LED active
- Scale Zero Button active
- Scale Zero Button and Scale Indicator LED disconnected



NOTE: The options on this page are for adaptive scale bonnet integration only.

1. Scan the Enter/Exit Programming Mode bar code.
2. Scan the desired mode bar code from those provided below You'll need to cover any unused bar codes on facing pages to ensure that the scanner reads only the bar code you intend to scan.
3. Complete the programming sequence by scanning the Enter/Exit Programming Mode bar code.



Scale Zero Button and Scale Indicator LED = Scale
Zero Button and Scale Indicator LED active



Scale Zero Button and Scale Indicator LED = Scale Indi-
cator LED active



Scale Zero Button and Scale Indicator LED =
Scale Zero Button active



★ Scale Zero Button and Scale Indicator LED = Scale Zero
Button and Scale Indicator LED disconnected



Scale Sentry

This option enables or disables the ability of the scanner to monitor items placed on the platter to ensure they are not overhanging non-weighting surfaces. See the topic [Scale Sentry™ Option](#) in the [Introduction](#) chapter for more information.

To set this feature:

1. Scan the ENTER/EXIT Programming Mode bar code.
2. Scan your selection from the bar codes below. You'll need to cover any unused bar codes on this and the facing page to ensure that the scanner reads only the bar code you intend to scan.
3. Complete the programming sequence by scanning the ENTER/EXIT Programming Mode bar code.



Scale Sentry = Disable



★ Scale Sentry = Enable

Scale Sentry Block Weight Transmission



NOTE: This feature may not apply to Adaptive Scale models.

This option enables or disables weight transmission to the host if a Scale Sentry event is active. When enabled, this feature blocks the transmission of weight data to the host if Scale Sentry has sensed an item or items overhanging the side(s) of the scale platter. Weight will be transmitted when:

- Items are repositioned on the scale platter so as to move them towards the center and away from the edges.
- The Scale Sentry Override Button is pressed.



NOTE: The Scale Sentry Override Button must be enabled to perform this function via the following feature, .

To set this feature:

1. Scan the ENTER/EXIT Programming Mode bar code.
2. Scan your selection from the bar codes below. You'll need to cover any unused bar codes on this and the facing page to ensure that the scanner reads only the bar code you intend to scan.
3. Complete the programming sequence by scanning the ENTER/EXIT Programming Mode bar code.



Scale Sentry Block Weight Transmission = Disable



★ Scale Sentry Block Weight Transmission = Enable



Scale Sentry Override Button

This option allows a press of the Scale Sentry Override Button to manually clear a Scale Sentry event.

To set this feature:

1. Scan the ENTER/EXIT Programming Mode bar code.
2. Scan your selection from the bar codes below. You'll need to cover any unused bar codes on this and the facing page to ensure that the scanner reads only the bar code you intend to scan.
3. Complete the programming sequence by scanning the ENTER/EXIT Programming Mode bar code.



Scale Sentry Override Button = Disable



★ Scale Sentry Override Button = Enable

Scale Sentry Mode

Specifies the operating mode for Scale Sentry.

To set this feature:

1. Scan the ENTER/EXIT Programming Mode bar code.
2. Scan your selection from the bar codes below. You'll need to cover any unused bar codes on this and the facing page to ensure that the scanner reads only the bar code you intend to scan.
3. Complete the programming sequence by scanning the ENTER/EXIT Programming Mode bar code.



Scale Sentry Mode = Indication Only



★ Scale Sentry Mode = Weight Integration



Scale Sentry GRI Enable

Enables/Disables use of good read indicator for scale sentry indications.

To set this feature:

1. Scan the ENTER/EXIT Programming Mode bar code.
2. Scan your selection from the bar codes below. You'll need to cover any unused bar codes on this and the facing page to ensure that the scanner reads only the bar code you intend to scan.
3. Complete the programming sequence by scanning the ENTER/EXIT Programming Mode bar code.



Scale Sentry GRI = Disable



★ Scale Sentry GRI = Enable

Scale Sentry Adaptive Scale Indication State

Defines the indication state of the adaptive Scale Sentry output pin.

To set this feature:

1. Scan the ENTER/EXIT Programming Mode bar code.
2. Scan your selection from the bar codes below. You'll need to cover any unused bar codes on this and the facing page to ensure that the scanner reads only the bar code you intend to scan.
3. Complete the programming sequence by scanning the ENTER/EXIT Programming Mode bar code.



Scale Sentry Adaptive Scale
Indication State = Active Low



★ Scale Sentry Adaptive Scale
Indication State = Active High



Adaptive Scale LED Option

Defines which LED is used for adaptive scale indication.

To set this feature:

1. Scan the ENTER/EXIT Programming Mode bar code.
2. Scan your selection from the bar codes below. You'll need to cover any unused bar codes on this and the facing page to ensure that the scanner reads only the bar code you intend to scan.
3. Complete the programming sequence by scanning the ENTER/EXIT Programming Mode bar code.



★ Adaptive Scale LED Option = Zero LED



Adaptive Scale LED Option = Scale Sentry LED

Scale Enable



NOTE: This feature does not apply to Adaptive Scale models.

Use this feature to enable or disable scale operation.



NOTE: Recalibration/recertification may be required when adding scale functionality. Consult your local Weights and Measures authority.

To set this feature:

1. Scan the Enter/Exit Programming Mode bar code.
2. Scan your selection from the bar codes below. You'll need to cover any unused bar codes on this and the facing page to ensure that the scanner reads only the bar code you intend to scan.
3. Complete the programming sequence by scanning the Enter/Exit Programming Mode bar code.



Scale = Disable



★ Scale = Enable



Scale Diagnostics Mode



NOTE: This feature does not apply to Adaptive Scale models.

Use this feature to allow or disallow the ability of an operator to initiate the advanced feature, scale diagnostics.

To set this feature:

1. Scan the Enter/Exit Programming Mode bar code.
2. Scan your selection from the bar codes below. You'll need to cover any unused bar codes on this and the facing page to ensure that the scanner reads only the bar code you intend to scan.
3. Complete the programming sequence by scanning the Enter/Exit Programming Mode bar code.



Scale Diagnostics Mode = Disable



★ Scale Diagnostics Mode = Enable

Scale Stale Weight Timeout



NOTE: This feature does not apply to Adaptive Scale models.

This option specifies the amount of time that scale data is presented to the host before being discarded.

To set this feature:

1. Scan the Enter/Exit Programming Mode bar code.
2. Scan the bar code, [Set Scale Stale Weight Timeout](#) below. You'll need to cover any unused bar codes on this and the facing page to ensure that the scanner reads only the bar code you intend to scan.
3. Scan the appropriate digits from the [Keypad](#) in [Appendix C](#) that represent the desired time interval. The selectable range is 20-33 in 10ms increments.

Scan the Enter/Exit Programming Mode bar code to exit Programming Mode.



Set Scale Stale Weight Timeout

★ Default setting for this feature is: 330 milliseconds



Scale Enforced Zero Return



NOTE: This feature does not apply to Adaptive Scale models.

This feature sets the mode of enforcing the scale re-zeroing operation:

- Disable
- Non-zero for more than 4 minutes OR below zero
- Non-zero for more than 4 minutes OR below zero OR no zero between weights

1. Scan the Enter/Exit Programming Mode bar code.
2. Scan your selection from the bar codes below. You'll need to cover any unused bar codes on this and the facing page to ensure that the scanner reads only the bar code you intend to scan. The strategy is to select the lowest possible filter level needed that allows normal scale operation.
3. Complete the programming sequence by scanning the Enter/Exit Programming Mode bar code.



Scale Enforced Zero Return = Disable



Scale Enforced Zero Return = Non Zero for More Than
4 minutes OR Below Zero



Scale Enforced Zero Return = Non Zero for More Than
4 minutes OR Below Zero OR No Zero Between
Weights



★ Scale Enforced Zero Return = Non Zero for 4 minutes

Scale Interface Type

Use this feature to select the scale interface type. Choices are:.

- No scale interface
- IBM 46XX (Port 17 ignored)
- Mettler Toledo 8217
- USB (IBM ignored)
- RS-232 - SASI
- RS-232 - ICL
- Legacy ICL
- Tesco ICL
- Avery XA9 Weigh-Only
- Avery 1791
- Toledo Brazil P05
- Toledo Brazil P05A
- Dialog04/02
- Dialog06

To set this feature:

1. Scan the Enter/Exit Programming Mode bar code.
2. Scan your selection from the bar codes below. You'll need to cover any unused bar codes on this and the facing page to ensure that the scanner reads only the bar code you intend to scan.
3. Complete the programming sequence by scanning the Enter/Exit Programming Mode bar code.



Scale Interface Type = No Scale Interface



Scale Interface Type = IBM 46XX (Port 17 Ignored)



Scale Interface Type = Mettler Toledo (8217 ignored)



Scale Interface Type (continued)



Scale Interface Type = USB (IBM ignored)



★ Scale Interface Type = RS-232 - SASI

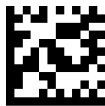

Scale Interface Type = RS-232 - ICL



Scale Interface Type = Legacy ICL



Scale Interface Type = Tesco ICL



Scale Interface Type = Avery XA9 Weigh-Only



Scale Interface Type = Avery 1791



Scale Interface Type = Toledo Brazil P05

Scale Interface Type (continued)



Scale Interface Type = Toledo Brazil P05A



Scale Interface Type = Dialog04/02



Scale Interface Type = Dialog06



Scale Baud Rate

This feature sets the RS-232 scale baud rate setting for scale interfaces that have adjustable baud rate. The options are:

- default
- 1200 baud
- 2400 baud
- 4800 baud
- 9600 baud
- 19200 baud
- 38400 baud
- 57600 baud
- 115200 baud
- 230400 baud
- 460800 baud
- 912600 baud

To set this feature:

1. Scan the Enter/Exit Programming Mode bar code.
2. Scan your selection from the bar codes below. You'll need to cover any unused bar codes on this and the facing page to ensure that the scanner reads only the bar code you intend to scan.
3. Complete the programming sequence by scanning the Enter/Exit Programming Mode bar code.



★ Scale Baud Rate = default



Scale Baud Rate = 1200



Scale Baud Rate = 2400



Scale Baud Rate = 4800

Scale Baud Rate (continued)



Scale Baud Rate = 9600



Scale Baud Rate = 19200



Scale Baud Rate = 38400



Scale Baud Rate = 57600



Scale Baud Rate = 115200



Scale Baud Rate = 230400



Scale Baud Rate = 460800



Scale Baud Rate = 912600



Scale Interface Settings

This feature sets the parity, stop bit and data bits for the scale interfaces. The options are:

Bits 0-1 = Parity

- 0 = default
- 1 = even
- 2 = odd
- 3 = none

Bit 2 = reserved

Bit 3 = word length

- 0 = 8 bit word (7 data bits if parity is set, 8 data bits if no parity)
- 1 = 9 bit word (8 data bits if parity is set, 9 data bits if no parity)

Bits 4-5 = stop bits

- 0 = 1 stop bit
- 2 = 2 stop bits

Bits 6-7 = reserved



NOTE: Default interface setting depends on the value set in “Scale Interface Type” on page 125.



★ Scale Interface Settings = default



Scale Interface Settings = even, 8, 1



Scale Interface Settings = odd, 8, 1



Scale Interface Settings = N, 8, 1

Scale Interface Options

Specifies various tare and price-weight related scale options.

- Bit 0 = Don't transmit MT8213/MT8217 decimal point
- Bit 1 = Reserved for future use
- Bit 2 = Clear the tare after every weight request
- Bit 3 = Clear the unit price after every price-weight request
- Bit 4 = Consider a zero weight as under the minimum allowable value for Dialog04 and Dialog06



★ Scale Interface Options = default



Scale Interface Options =
Don't transmit MT8213/MT8217 decimal point



Scale Interface Options =
Clear the tare after every weight request



Scale Interface Options =
Clear the unit price after every price-weight request



Scale Interface Options = Consider a zero weight as
under the minimum allowable value for Dialog04 and
Dialog06



ICL Scale Interface DC1 Character Delay

When using the RS-232 ICL scale interface type, this option enables/disables the ability of the scanner to delay DC1 response for 40 milliseconds.

To set this feature:

1. Scan the Enter/Exit Programming Mode bar code.
2. Scan your selection from the bar codes below. You'll need to cover any unused bar codes on this and the facing page to ensure that the scanner reads only the bar code you intend to scan.
3. Complete the programming sequence by scanning the Enter/Exit Programming Mode bar code.



★ ICL Scale Interface DC1 Character Delay = Disable



ICL Scale Interface DC1 Character Delay = Enable

Team POS ICL Scale Mode Enable

RS-232 Team POS ICL Scale enables/disables the ability of the scanner to enter TEAM POS ICL Scale mode.

To set this feature:

1. Scan the Enter/Exit Programming Mode bar code.
2. Scan your selection from the bar codes below. You'll need to cover any unused bar codes on this and the facing page to ensure that the scanner reads only the bar code you intend to scan.
3. Complete the programming sequence by scanning the Enter/Exit Programming Mode bar code.



★ RS-232 Team POS ICL Scale = Disable <04A000>



RS-232 Team POS ICL Scale = Enable <04A001>



Scale Calibration Notification



NOTE: This feature does not apply to Adaptive Scale models.

This option enables a notification that scale calibration has taken place.

To set this feature:

1. Scan the Enter/Exit Programming Mode bar code.
2. Scan your selection from the bar codes below. You'll need to cover any unused bar codes on this and the facing page to ensure that the scanner reads only the bar code you intend to scan.
3. Complete the programming sequence by scanning the Enter/Exit Programming Mode bar code.



★ Scale Calibration Notification = Disable



Scale Calibration Notification = Enable

Scale Intercharacter Delay



NOTE: This feature does not apply to Adaptive Scale models.

With regard to scale functions, this feature specifies a delay between the end of one character and the beginning of the next in 10-millisecond increments.

To set the Scale Intercharacter Delay:

1. Scan the Enter/Exit Programming Mode bar code.
2. Scan the bar code below, [Set Scale Intercharacter Delay](#). You'll need to cover any unused bar codes on this and the facing page to ensure that the scanner reads only the bar code you intend to scan.
3. Scan the appropriate digits from the [Keypad](#) in [Appendix C](#) that represent the desired delay. The selectable range is 0-255, which is the delay in 10-millisecond increments. Pad all single and double digit numbers with leading zeroes to yield a three-digit entry (000-255).
Examples:
001 = 10ms
005 = 50ms
040 = 400ms
100 = 1,000ms (1 second)
4. The scanner will automatically exit Programming Mode when the appropriate amount of digits have been scanned.



Set Scale Intercharacter Delay

★ Default setting for this feature is:
00 - No Intercharacter Delay



REMOTE DISPLAY — ENABLE/DISABLE

The scanner-scale can be configured to operate with or without a Remote Display.



NOTE: Recalibration/recertification may be required when adding a Remote Display. Consult your local Weights and Measures authority.

If this feature is enabled the scanner will expect that it is connected to a Remote Display, and will indicate an error if one is not. See Error Codes in the Problem Isolation section for more information.

To set this feature:

1. Scan the Enter/Exit Programming Mode bar code.
2. Scan your selection from the bar codes below. You'll need to cover any unused bar codes on this and the facing page to ensure that the scanner reads only the bar code you intend to scan.
3. Complete the programming sequence by scanning the Enter/Exit Programming Mode bar code.



Remote Display = Disable



★ Remote Display = Enable

AUXILIARY USB MODE

This option specifies the function of the USB auxiliary port.

To set this feature:

1. Scan the Enter/Exit Programming Mode bar code.
2. Scan your selection from the bar codes below. You'll need to cover any unused bar codes on this and the facing page to ensure that the scanner reads only the bar code you intend to scan.
3. Complete the programming sequence by scanning the Enter/Exit Programming Mode bar code.



★ Auxiliary USB Mode = Disable



Auxiliary USB Mode = PIR/CT Output + Diagnostics
Reporting



USB DEVICE PORT LOCATION

Chooses USB device port location (under scale platter or on back panel).

To set this feature:

1. Scan the Enter/Exit Programming Mode bar code.
2. Scan your selection from the bar codes below. You'll need to cover any unused bar codes on this and the facing page to ensure that the scanner reads only the bar code you intend to scan.
3. Complete the programming sequence by scanning the Enter/Exit Programming Mode bar code.



★ USB Device Port Location = Topside Connector



USB Device Port Location = Rear Panel Connector

PIR / CT

When PIR /CT (Productivity Index Reporting/Cashier Training) is enabled, label quality data is appended to decoded data before being presented to the POS. The PIR feature allows the scanner to provide information to an external computer indicating how easy the label was to read. CT allows the scanner to provide feedback to the cashier on how to scan in a more ergonomic fashion.

To set this feature:gm

1. Scan the Enter/Exit Programming Mode bar code.
2. Scan your selection from the bar codes below. You'll need to cover any unused bar codes on this and the facing page to ensure that the scanner reads only the bar code you intend to scan.
3. Complete the programming sequence by scanning the Enter/Exit Programming Mode bar code.



★ PIR / CT = Disable



PIR / CT = Enable

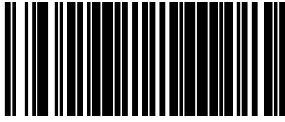

NOTES

EAS FEATURES

SECTION CONTENTS	
EAS FEATURES — SENSORMATIC starting on page 142	
<ul style="list-style-type: none">• EAS Mode• EAS Notification• EAS Security Level• EAS Good Beep Mode• EAS Beep Duration• EAS Retry Count	<ul style="list-style-type: none">• EAS Exception Button• EAS Deactivation Duration — Coupled• EAS Deactivation Duration — Retry• EAS Deactivation Duration — Exception• EAS Pre-Read Time
EAS FEATURES — CHECKPOINT starting on page 154	
<ul style="list-style-type: none">• ERI Active State	<ul style="list-style-type: none">• ERI Timeout



EAS FEATURES — SENSORMATIC



NOTE: These features control the Sensormatic® AMB-9010 or ScanMax-Pro EAS controller box. This orderable option is installed at the time of manufacture. See "EAS Features — Checkpoint" on page 154 to set options for the Checkpoint® EAS system.

EAS Mode

This controls the mode of operation for interfacing with the Sensormatic® AMB-9010 or ScanMaxPro EAS controller box. Choices are:

- Disabled = EAS deactivation turned off.
- Coupled Mode = EAS tag is deactivated only upon successful scanning of an item's bar code or via EAS Exception Button.
- Decoupled Mode = EAS deactivation is performed independently of bar code scanning.
- Hybrid Mode = EAS system is armed whenever the scanner is enabled and the deactivation beep is sounded when an EAS tag is deactivated.
- Host Coupled Mode = Fundamental controls and notification of various EAS events are provided to the POS system.



NOTE: Deactivation can only be initiated manually if the EAS Exception Button is armed to do so. Reference the feature "EAS Exception Button" on page 149 for more information.

To set this feature:

1. Scan the Enter/Exit Programming Mode bar code.
2. Scan your selection from the bar codes below. You'll need to cover any unused bar codes on this and the facing page to ensure that the scanner reads only the bar code you intend to scan.
3. Complete the programming sequence by scanning the Enter/Exit Programming Mode bar code.



EAS Mode (continued)

Remember to cover any unused bar codes on this and the facing page to ensure that the scanner reads only the bar code you intend to scan.



★ EAS Mode = Disable



EAS Mode = Coupled Mode



EAS Mode = Decoupled Mode



EAS Mode = Hybrid Mode

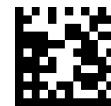

EAS Mode = Host Coupled Mode



EAS Notification

This feature specifies the output mode and activation of EAS event notification when operating in Coupled Mode.

To set this feature:

1. Scan the Enter/Exit Programming Mode bar code.
2. Scan your selection from the bar codes below. You'll need to cover any unused bar codes on this and the facing page to ensure that the scanner reads only the bar code you intend to scan.
3. Complete the programming sequence by scanning the Enter/Exit Programming Mode bar code.



★ EAS Notification = Disable



EAS Notification = Notification over POS Port



EAS Security Level

This feature defines the level of EAS security for operating in coupled mode.

To set this feature:

1. Scan the Enter/Exit Programming Mode bar code.
2. Scan your selection from the bar codes below. You'll need to cover any unused bar codes on this and the facing page to ensure that the scanner reads only the bar code you intend to scan.
3. Complete the programming sequence by scanning the Enter/Exit Programming Mode bar code.



EAS Security Level = Low



★ EAS Security Level = Medium



EAS Security Level = High



EAS Good Beep Mode

This feature sets the mode of operation for the EAS deactivation beep while operating in coupled mode.

To set this feature:

1. Scan the Enter/Exit Programming Mode bar code.
2. Scan your selection from the bar codes below. You'll need to cover any unused bar codes on this and the facing page to ensure that the scanner reads only the bar code you intend to scan.
3. Complete the programming sequence by scanning the Enter/Exit Programming Mode bar code.



★ EAS Good Beep Mode = Disable



EAS Good Beep Mode = Beep on Deactivate



EAS Good Beep Mode = Beep on Verify



EAS Beep Duration

Sets the duration of the EAS successful deactivation beep, specified in 10ms increments. The beep only occurs if EAS mode is not disabled.

To set the EAS Beep Duration:

1. Scan the Enter/Exit Programming Mode bar code.
2. Scan the bar code, [Set EAS Beep Duration](#) below. You'll need to cover any unused bar codes on this and the facing page to ensure that the scanner reads only the bar code you intend to scan.
3. Scan the appropriate digits from the [Keypad](#) in [Appendix C](#) that represent the desired EAS Beep Duration. The selectable range is 0-255, which is the timeout in 10-millisecond increments. Pad all single and double digit numbers with leading zeroes to yield a three-digit entry (000-255).

Examples:

000 = EAS beep disabled

001 = 10ms

005 = 50ms

040 = 400ms

250 = 2,500ms (2.5 seconds)

4. Complete the programming sequence by scanning the nter/Exit Programming Mode bar code.



Set EAS Beep Duration

★ Default setting for this feature is:

008 - 80ms



EAS Retry Count

This feature sets the number of times the deactivation sequence (defined by the feature, “EAS Deactivation Duration — Retry”) is restarted after a failed deactivation attempt.

To set this feature:

1. Scan the Enter/Exit Programming Mode bar code.
2. Scan the bar code, [Set EAS Retry Count](#) below. You’ll need to cover any unused bar codes on this and the facing page to ensure that the scanner reads only the bar code you intend to scan.
3. Scan the appropriate digits from the [Keypad](#) in [Appendix C](#) that represent the desired number. The selectable range is 0-15 resets. Pad all single and double digit numbers with leading zeroes to yield a two-digit entry (00-15).



NOTE: A setting of zero specifies no deactivation retries upon failed deactivation attempt.

4. Complete the programming sequence by scanning the Enter/Exit Programming Mode bar code.



Set EAS Retry Count

★ Default setting for this feature is:
03 - Retry EAS Deactivation three times



EAS Exception Button

This feature is for use in Coupled Mode¹. When it is enabled, EAS deactivation can be manually initiated by placing the item with the EAS tag downstream² of the horizontal scan window and pushing the EAS Exception Push Button.



NOTE: The scanner emits a clicking sound while in deactivation state. Duration of deactivation state is determined by the feature, EAS Deactivation Duration — Manual.

Options are:

- DISABLE — EAS Exception Button is disabled.
- ENABLE ALWAYS — The EAS Exception Button is always enabled.
- ENABLE ONLY WHEN SCANNER ENABLED — The EAS Exception Button is only available when the scanner is enabled and running.



NOTE: Statistics are collected each time the EAS Exception Button is used to deactivate an EAS tag.

To set this feature:

1. Scan the Enter/Exit Programming Mode bar code.
2. Scan your selection from the bar codes below. You'll need to cover any unused bar codes on this and the facing page to ensure that the scanner reads only the bar code you intend to scan.

Complete the programming sequence by scanning the Enter/Exit Programming Mode bar code.



EAS Exception Button = Disabled



EAS Exception Button = Enable Always



★ EAS Exception Button = Enable ONLY When Scanner Enabled

1. See "EAS Mode" on page 142 for more information about Coupled Mode.
 2. "Downstream" in this case is defined as being the downstream side of the scan window from the direction of product flow, or scanning direction.

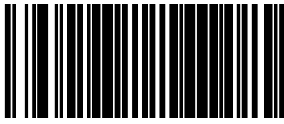

EAS Deactivation Duration — Coupled

Specifies the amount of time EAS deactivation is operative once the function has been initiated following a bar code read.



NOTE: This setting pertains only to units configured for EAS Coupled Mode. Reference the EAS Mode description for more information about Coupled and Decoupled EAS operation.

To set the EAS Deactivation Duration — Coupled:

1. Scan the Enter/Exit Programming Mode bar code.
2. Scan the bar code, [Set EAS Deactivation Duration — Coupled](#) below. You'll need to cover any unused bar codes on this and the facing page to ensure that the scanner reads only the bar code you intend to scan.
3. Scan the appropriate digits from the [Keypad](#) in [Appendix C](#) that represent the desired duration. The selectable range is 1-255, which is the duration in 10-millisecond increments. Pad all single and double digit numbers with leading zeroes to yield a three-digit entry (001-255).

Examples:

005 = 50ms

040 = 400ms

250 = 2,500ms (2.5 seconds)

4. The scanner will automatically exit Programming Mode when the appropriate amount of digits have been scanned.



Set EAS Deactivation Duration — Coupled

★ Default setting for this feature is:

040 = 400ms



EAS Deactivation Duration — Retry

Specifies the amount of time EAS deactivation is operative once the function has been initiated following EAS tag detection (prior to bar code read).



NOTE: This setting pertains only to units configured for EAS Coupled Mode. Reference the EAS Mode description for more information about Coupled and Decoupled EAS operation. Also reference EAS Retry Count.

To set the EAS Deactivation Duration — Retry:

1. Scan the Enter/Exit Programming Mode bar code.
2. Scan the bar code, [Set EAS Deactivation Duration — Retry](#) below. You'll need to cover any unused bar codes on this and the facing page to ensure that the scanner reads only the bar code you intend to scan.
3. Scan the appropriate digits from the [Keypad](#) in [Appendix C](#) that represent the desired duration. The selectable range is 1-255, which is the duration in 10-millisecond increments. Pad all single and double digit numbers with leading zeroes to yield a three-digit entry (001-255).

Examples:

005 = 50ms

040 = 400ms

250 = 2,500ms (2.5 seconds)

4. The scanner will automatically exit Programming Mode when the appropriate amount of digits have been scanned.



Set EAS Deactivation Duration — Retry

★ Default setting for this feature is:

050 -500ms

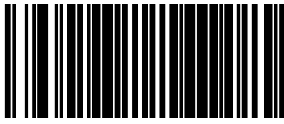

EAS Deactivation Duration — Exception

Specifies the amount of time EAS deactivation is operative upon pushing the EAS Exception Button.



NOTE: This setting pertains only to units configured for EAS Coupled Mode. Reference the EAS Mode description for more information about Coupled and Decoupled EAS operation. Also reference EAS Retry Count.

To set the EAS Deactivation Duration — Exception:

1. Scan the Enter/Exit Programming Mode bar code.
2. Scan the bar code, [Set EAS Deactivation Duration — Exception](#) below. You'll need to cover any unused bar codes on this and the facing page to ensure that the scanner reads only the bar code you intend to scan.
3. Scan the appropriate digits from the [Keypad in Appendix C](#) that represent the desired duration. The selectable range is 1-255, which is the duration in 10-millisecond increments. Pad all single and double digit numbers with leading zeroes to yield a three-digit entry (001-255).

Examples:

005 = 50ms

040 = 400ms

250 = 2,500ms (2.5 seconds)

4. The scanner will automatically exit Programming Mode when the appropriate amount of digits have been scanned.



Set EAS Deactivation Duration — Exception

★ Default setting for this feature is:

100 - 1 Second



EAS Pre-Read Time

This feature specifies the time duration that must elapse before reading a label once an EAS tag is sensed.

To set this feature:

1. Scan the Enter/Exit Programming Mode bar code.
2. Scan the bar code, [Set EAS Pre-Read Time](#) below. You'll need to cover any unused bar codes on this and the facing page to ensure that the scanner reads only the bar code you intend to scan.
3. Scan the appropriate digits from the [Keypad](#) in [Appendix C](#) that represent the desired duration. The selectable range is 000-255, which is the duration in 10-millisecond increments. Pad all single and double digit numbers with leading zeroes to yield a three-digit entry (000-255).

Examples:

005 = 50ms

040 = 400ms

250 = 2,500ms (2.5 seconds)

4. The scanner will automatically exit Programming Mode when the appropriate amount of digits have been scanned.



Set EAS Pre-Read Time

★ Default setting for this feature is:

025 = 250ms

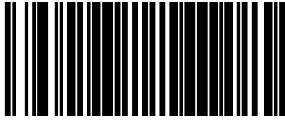

EAS FEATURES — CHECKPOINT

The features in this section apply only to Checkpoint® EAS systems. See "EAS Features — Sensormatic" on page 142 to set options for that system.

ERI Active State

Specifies the active state polarity of ERI; the inactive state is its opposite polarity. ERI output goes active during the good read of a bar code, allowing the EAS device to deactivate a tag on the product.

To set the ERI Active State:

1. Scan the Enter/Exit Programming Mode bar code.
2. Scan your selection from the bar codes below. You'll need to cover any unused bar codes on this and the facing page to ensure that the scanner reads only the bar code you intend to scan.
3. Complete the programming sequence by scanning the Enter/Exit Programming Mode bar code.



★ ERI Active State = Active Low



ERI Active State = Active High

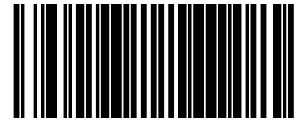

ERI Timeout

Specifies the amount of time that an ERI signal is held in its active state for a good read.

To set the ERI Timeout:

1. Scan the Enter/Exit Programming Mode bar code.
2. Scan the bar code, [Set ERI Timeout](#) below. You'll need to cover any unused bar codes on this and the facing page to ensure that the scanner reads only the bar code you intend to scan.
3. Scan the appropriate digits from the [Keypad](#) in [Appendix C](#) that represent the desired duration. The selectable range is 1-255, which is the duration in 10-millisecond increments. Pad all single and double digit numbers with leading zeros to yield a three-digit entry (001-255).

Examples:

000 = ERI timeout disabled

001 = 10ms

005 = 50ms

040 = 400ms

250 = 2,500ms (2.5 seconds)



NOTE: A setting of 0 (000) disables this feature.

4. The scanner will automatically exit Programming Mode when the appropriate amount of digits have been scanned.



Set ERI Timeout

★ Default setting for this feature is:

002 -20ms

NOTES

INTERFACE RELATED FEATURE

SECTION CONTENTS	
INTERFACE TYPE starting on page 159	
<ul style="list-style-type: none"> • RS-232 Interface Selection • USB Interface Selection 	<ul style="list-style-type: none"> • IBM Interface Selection • Keyboard Interface Selection
MAXIMUM HOST-TRANSMITTED MESSAGE LENGTH starting on page 165	
IBM FEATURES starting on page 166	
<ul style="list-style-type: none"> • IBM Interface Options • IBM Scale Address • IBM Transmit Labels in Code 39 Format 	<ul style="list-style-type: none"> • 46XX Number of Host Resets • 46XX Label Slicing Control 46XX Maximum Label Slice Length
USB OEM INTERFACE OPTIONS starting on page 172	
<ul style="list-style-type: none"> • USB OEM Scanner Device Type 	
RS-232 FEATURES starting on page 175	
<ul style="list-style-type: none"> • RS-232 Baud Rate • RS-232 Number of Data Bits • RS-232 Number of Stop Bits • RS-232 Parity • RS-232 Hardware Control • RS-232 Intercharacter Delay • RS-232 Software Flow Control • RS-232 Ignore Host Commands • RS-232 TTL • RS-232 TTL Invert 	<ul style="list-style-type: none"> • RS-232 Beep on ASCII BEL • RS-232 Beep After Weigh • Beep on Not on File • RS-232 ACK NAK Enable <ul style="list-style-type: none"> - RS-232 ACK Character - RS-232 NAK Character • RS-232 Retry on ACK NAK Timeout <ul style="list-style-type: none"> - RS-232 ACK NAK Timeout Value - RS-232 ACK NAK Retry Count - RS-232 ACK NAK Error Handling • RS-232 Indicate Transmission Failure
SINGLE CABLE RS-232 OPTIONS starting on page 197	
<ul style="list-style-type: none"> • Single Cable RS-232 Scanner Only Protocol • Single Cable RS-232 RTS CTS Selection • Single Cable RS-232 Use BCC • Single Cable RS-232 Use ACK/NAK • Single Cable RS-232 Use STX 	<ul style="list-style-type: none"> • Set Single Cable RS-232 STX Character • Single Cable RS-232 Use ETX <ul style="list-style-type: none"> - Set Single Cable RS-232 ETX Character • Single Cable RS-232 Datalogic Extensions • Single Cable RS-232 Pacesetter Plus

USB KEYBOARD AND KEYBOARD WEDGE FEATURES starting on page 209

- | | |
|---|--|
| <ul style="list-style-type: none">• USB Keyboard and Keyboard Wedge Intercharacter Delay• Keyboard Wedge No Keyboard Support• USB Keyboard and Keyboard Wedge Send Control Characters | <ul style="list-style-type: none">• USB Keyboard and Keyboard Wedge Country Mode• Keyboard Wedge Quiet Interval• USB Keyboard and Keyboard Wedge Caps Lock State |
|---|--|



INTERFACE TYPE

Specifies the current scanner interface. Selections are:

INTERFACE (I/F) TYPE	I/F I.D. NUMBER ^a
RS-232 Standard	05
RS-232 Wincor-Nixdorf	12
RS-232 Single Cable	20
USB OEM	45
IBM Port 17	04
IBM Port 5B	08
IBM Port 9B	23
USB Keyboard	35
USB-TEC	0D
USB COM	47

NOT USER-SELECTABLE	
System Interface	7-segment FRU display indicates 0 at start-up (accompanied by trill beep for approx. 2 seconds)

- a. To access a scanner's interface identification number, place the scanner in Scanner Diagnostic Mode and view the 7-segment FRU display (reference [Chapter 2, Scale Diagnostic Mode](#), for more information).



NOTE: A new scanner may have been shipped from the factory with a Null Interface (no interface type selected) to ensure system compatibility at installation. In this case, the correct Interface Type programming bar code must be scanned first before the scanner can be used with a POS system.



NOTE: If the scanner's interface type must be changed, always be sure that interface configuration is the **FIRST** item scanned during a programming session. (Selecting an interface type resets **ALL** other configuration items to the factory default for that interface type.)

To select the desired interface:



CAUTION: Great care should be taken to select the correct interface type, since you can cause damage to the scanner and/or POS terminal by attempting to change to an incompatible interface. **ALWAYS** make interface selections with the host cable **DISCONNECTED**.



NOTE: When an interface is selected, the scanner loads the configuration for that interface as the selection is made. Any custom configurations done in the previous interface will not be carried over to the configuration for the new interface.

1. Disconnect current interface cable(s) if currently connected.
2. Scan the Enter/Exit Programming Mode bar code.
3. Scan the bar code representing the appropriate interface located on the following pages. You'll need to cover any unused bar codes adjacent to and on any facing pages to ensure the scanner reads only the bar code you intend to scan.
4. Complete the programming sequence by scanning the Enter/Exit Programming Mode bar code.



NOTE: Once the correct interface has been set, it will be necessary to proceed to the appropriate pages in this manual that select parameters and options for that interface. For example, if RS-232 is selected, turn to the pages in this manual headed as features specific to the RS-232 interface.

5. Connect new interface cable(s).



RS-232 Interface Selection

Remember to cover any unused bar codes on this and the facing page to ensure that the scanner reads only the bar code you intend to scan.



CAUTION: Great care should be taken to select the correct interface type, since you can cause damage to the scanner and/or POS terminal by attempting to change to an incompatible interface. ALWAYS make interface selections with the host cable DISCONNECTED.



Interface Type = RS-232 Standard



Interface Type = RS-232 Wincor-Nixdorf



NOTE: Single cable installations require connection at the POS Terminal (host) port. The Scale Host port connection is not used for this interface.



Interface Type = RS-232 Single Cable



USB Interface Selection

Remember to cover any unused bar codes on this and the facing page to ensure that the scanner reads only the bar code you intend to scan.



CAUTION: Great care should be taken to select the correct interface type, since you can cause damage to the scanner and/or POS terminal by attempting to change to an incompatible interface. ALWAYS make interface selections with the host cable DISCONNECTED.



NOTE: Single cable installations require connection at the POS Terminal (host) port. The Scale Host port connection is not used for this interface.



Interface Type = USB OEM



Interface Type = USB TEC



Interface Type = USB COM

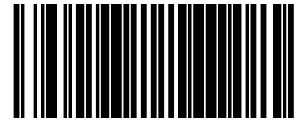

IBM Interface Selection

Remember to cover any unused bar codes on this and the facing page to ensure that the scanner reads only the bar code you intend to scan.



CAUTION: Great care should be taken to select the correct interface type, since you can cause damage to the scanner and/or POS terminal by attempting to change to an incompatible interface. ALWAYS make interface selections with the host cable DISCONNECTED.



NOTE: Single cable installations require connection at the POS Terminal (host) port. The Scale Host port connection is not used for this interface.



Interface Type = IBM Port 17



Interface Type = IBM Port 5B



Interface Type = IBM 4683 Port 9B

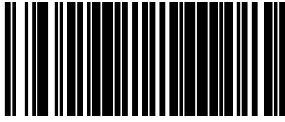

Keyboard Interface Selection

Remember to cover any unused bar codes on this and the facing page to ensure that the scanner reads only the bar code you intend to scan.



CAUTION: Great care should be taken to select the correct interface type, since you can cause damage to the scanner and/or POS terminal by attempting to change to an incompatible interface. ALWAYS make interface selections with the host cable DISCONNECTED.



Interface Type = USB Keyboard



MAXIMUM HOST-TRANSMITTED MESSAGE LENGTH

Specifies the maximum number of data characters allowed in messages transmitted to the host.

To set the Maximum Host-Transmitted Message Length:

1. Scan the Enter/Exit Programming Mode bar code.
2. Scan the bar code, [Set Maximum Host-Transmitted Message Length](#) below. You'll need to cover any unused bar codes on this and the facing page to ensure that the scanner reads only the bar code you intend to scan.
3. Scan the appropriate digits from the [Keypad](#) in [Appendix C](#) that represent the desired maximum host-transmitted message length. The selectable range is 0-249 data characters. (Labels that are longer than this length are not read.) Pad all single and double digit numbers with leading zeroes to yield a three-digit entry (000-249).



NOTE: If this configuration item is set to 0 (000), there is no general length limit imposed on data being transmitted to the host.

4. The scanner will automatically exit Programming Mode when the appropriate amount of digits have been scanned.

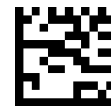

Set Maximum Host-Transmitted Message Length

★ Default setting for this feature is:
000 - No general limit imposed



IBM FEATURES

IBM Interface Options

IBM interfaces offer specific control over interaction with certain devices.



NOTE: The USB OEM interface provides its own set of options. Refer to the feature, USB OEM Interface Options, in this section.

Options for this feature are as follows:

- FULL host interface support — Accepts scanner and scale configuration host commands.
- Ignore host interface configuration of scanner and scale — Ignores all scanner and scale configuration host commands.

To set this feature:

1. Scan the Enter/Exit Programming Mode bar code.
2. Scan your selection from the bar codes below. You'll need to cover any unused bar codes on this and the facing page to ensure that the scanner reads only the bar code you intend to scan.
3. Complete the programming sequence by scanning the Enter/Exit Programming Mode bar code.



★ IBM Interface Option = Full Host Interface Support



IBM Interface Option = Ignore Host I/F Config of Scanner & Scale



IBM Scale Address



NOTE: This feature applies to IBM Port 17 ONLY.



NOTE: This feature does not apply to Adaptive Scale models.

Specifies IBM scale address for IBM Port 17. The following three addresses are available:

- 6A
- 6B
- 6E

To set the IBM Scale Address:

1. Scan the Enter/Exit Programming Mode bar code.
2. Scan the bar code below that represents the desired scale address designation.
3. Complete the programming sequence by scanning the Enter/Exit Programming Mode bar code.



IBM Scale Address = 6A



IBM Scale Address = 6b



★ IBM Scale Address = 6E



IBM Transmit Labels in Code 39 Format

This feature enables/disables scanner's ability to set a symbology identifier for a specified label to Code 39 before transmitting that label data to an IBM host. This applies to: Code 128, Code 93 and Codabar for IBM Port 5B; Code 93 and Codabar for IBM Port 9B; Code 128, Code 93 and Codabar for OEM-USB.



NOTE: When enabled, this feature has no effect on IBM Port 17.

To enable/disable the IBM Transmit Labels in Code 39 Format feature:

1. Scan the Enter/Exit Programming Mode bar code.
2. Scan either the enable or disable bar code below. You'll need to cover any unused bar codes on this and the facing page to ensure that the scanner reads only the bar code you intend to scan.
3. Complete the programming sequence by scanning the Enter/Exit Programming Mode bar code.



★ IBM Transmit Labels in Code 39 Format = Disable



IBM Transmit Labels in Code 39 Format = Enable



46XX Number of Host Resets

This setting specifies the number of consecutive resets before entering label Programming Mode to allow scanner configuration.

To set this feature:

1. Scan the Enter/Exit Programming Mode bar code.
2. Scan the bar code, [Set 46XX Number of Host Resets](#) below. You'll need to cover any unused bar codes on this and the facing page to ensure that the scanner reads only the bar code you intend to scan.
3. Scan the appropriate digits from the [Keypad](#) in [Appendix C](#) that represent the desired number of resets. The selectable range is 01-15 data characters. Pad all single digit numbers with a leading zero to yield a two-digit entry (01-15).
4. Scan the Enter/Exit Programming Mode bar code to exit Programming Mode.



Set 46XX Number of Host Resets

★ Default setting for this feature is: 06 (six resets)

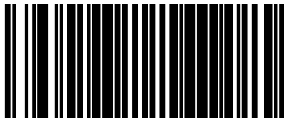

46XX Label Slicing Control

This feature enables slicing of IBM 46XX host data into multiple pieces when a label is longer than the length specified by the feature [46XX Maximum Label Slice Length](#).

To set this feature:

1. Scan the ENTER/EXIT Programming Mode bar code.
2. Scan your selection from the barcodes below. You'll need to cover any unused barcodes on this and the facing page to ensure that the scanner reads only the barcode you intend to scan.
3. Complete the programming sequence by scanning the ENTER/EXIT Programming Mode bar code.



46XX Label Slicing Control = Send Data in One Piece



★ 46XX Label Slicing Control = Slice Data Into Multiple Pieces if Necessary



46XX Maximum Label Slice Length

This feature specifies the maximum allowable length of host transmitted data in each sdhc frame.



NOTE: This setting only applies when 46XX Label Slicing Control is enabled.

To set this feature:

1. Scan the Enter/Exit Programming Mode bar code.
2. Scan the bar code, [Set 46XX Maximum Label Slice Length](#). You'll need to cover any unused bar codes on this and the facing page to ensure that the scanner reads only the bar code you intend to scan.
3. Scan the appropriate digits from the keypad in [Appendix C](#) that represent the desired length setting. The selectable range is 001-246 (a setting of 000 indicates no length limitation). Pad all single and double digit numbers with leading zeroes to yield a three-digit entry (001-246).
4. Complete the programming sequence by scanning the ENTER/EXIT Programming Mode bar code.



Set 46XX Maximum Label Slice Length

★ Default setting for this feature is:
040 - 64 Characters



USB OEM INTERFACE OPTIONS

The OEM-USB interface offers specific control over interaction with certain devices. Options for this feature are as follows:

- FULL host interface support — Accepts scanner and scale configuration host commands.
- Compatible with Magellan SL host interface support — Uses Magellan SL host interface support.
- Ignore host interface configuration of scanner and scale — Ignores all scanner and scale configuration host commands.



NOTE: This feature applies only to the USB OEM interface. For other IBM interfaces, refer to the feature, IBM Interface Options, earlier in this section.

To set this feature:

1. Scan the Enter/Exit Programming Mode bar code.
2. Scan your selection from the bar codes below. You'll need to cover any unused bar codes on this and the facing page to ensure that the scanner reads only the bar code you intend to scan.
3. Complete the programming sequence by scanning the Enter/Exit Programming Mode bar code.



USB OEM Interface Options = Full Interface Support



USB OEM Interface Options = Compatible with Magellan SL Host Interface Support



★ USB OEM Interface Options = Ignore Host Interface Configuration of Scanner and Scale



USB OEM Additional Interface Options

To set this feature:

1. Scan the Enter/Exit Programming Mode bar code.
2. Scan your selection from the bar codes below. You'll need to cover any unused bar codes on this and the facing page to ensure that the scanner reads only the bar code you intend to scan.

Complete the programming sequence by scanning the Enter/Exit Programming Mode bar code



USB OEM Interfaces Option2 =
Enable scanner at first enumeration after BusReset



★ USB OEM Interfaces Option2 =
Disable scanner at first enumeration after BusReset



USB OEM Scanner Device Type

The OEM-USB protocol allows for the scanner to be identified as one of two different types of bar code scanners. Depending on what other scanners you may already have connected to a USB POS, you may need to change this setting to enable all scanners to communicate. Options are:

- Table Top Scanner
- Handheld Scanner

To set this feature:

1. Scan the Enter/Exit Programming Mode bar code.
2. Scan your selection from the bar codes below. You'll need to cover any unused bar codes on this and the facing page to ensure that the scanner reads only the bar code you intend to scan.
3. Complete the programming sequence by scanning the Enter/Exit Programming Mode bar code.



★ USB OEM Scanner Device Type = Table Top Scanner



USB OEM Scanner Device Type = Handheld Scanner



RS-232 FEATURES

RS-232 Baud Rate

This feature selects the baud rate required for sending and receiving data.



NOTE: Single cable interfaces are limited to Baud Rate selections up to 19200. They cannot communicate at Baud Rates of 38400 and up.

To specify the RS-232 Baud Rate:

1. Scan the Enter/Exit Programming Mode bar code.
2. Scan the desired baud rate from the bar codes below and on the immediately following pages. You'll need to cover any unused bar codes on this and the facing page to ensure that the scanner reads only the bar code you intend to scan.
3. Complete the programming sequence by scanning the Enter/Exit Programming Mode bar code.



RS-232 Baud Rate = 1200



RS-232 Baud Rate = 2400



RS-232 Baud Rate = 4800



★ RS-232 Baud Rate = 9600



RS-232 Baud Rate = 19200

RS-232 Baud Rate (continued)

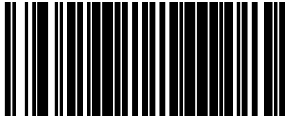

RS-232 Baud Rate = 38400



RS-232 Baud Rate = 57600



RS-232 Baud Rate = 115200



RS-232 Baud Rate = 230400



RS-232 Baud Rate = 460800



RS-232 Baud Rate = 921600



RS-232 Number of Data Bits

Specifies number of data bits required for sending and receiving data.



NOTE: A setting of 7 data bits with no parity will default to 8 data bits and no parity.

To set this feature:

1. Scan the Enter/Exit Programming Mode bar code.
2. Scan the bar code below representing the desired Data Bit setting. You'll need to cover any unused bar codes on this and the facing page to ensure that the scanner reads only the bar code you intend to scan.
3. Complete the programming sequence by scanning the Enter/Exit Programming Mode bar code.



RS-232 Number of Data Bits = 7



★ RS-232 Number of Data Bits = 8



RS-232 Number of Stop Bits

Specifies number of stop bits required for sending and receiving data.

To set this feature:

1. Scan the Enter/Exit Programming Mode bar code.
2. Scan the bar code below representing the desired Stop Bit setting. You'll need to cover any unused bar codes on this and the facing page to ensure that the scanner reads only the bar code you intend to scan.
3. Complete the programming sequence by scanning the Enter/Exit Programming Mode bar code.



★ RS-232 Number of Stop Bits = 1



RS-232 Number of Stop Bits = 2



RS-232 Parity

Specifies parity required for sending and receiving data.

Options for this setting are:

- RS-232 PARITY = NONE
- RS-232 PARITY = EVEN
- RS-232 PARITY = ODD



NOTE: A setting of no parity with 7 data bits will default to 8 data bits and no parity.

To set this feature:

1. Scan the Enter/Exit Programming Mode bar code.
2. Scan the bar code below or on the following pages representing the desired Parity setting. You'll need to cover any unused bar codes, as well as facing pages to ensure that the scanner reads only the bar code you intend to scan.
3. Complete the programming sequence by scanning the Enter/Exit Programming Mode bar code.



★ RS-232 Parity = None



RS-232 Parity = Even



RS-232 Parity = Odd



RS-232 Hardware Control

Enables/disables use of the RS-232 CTS signal for flow control and/or scan control.

Options are:

- Disable — The scanner transmits to the host regardless of any activity on the CTS line.
- Enable CTS Flow Control — The CTS signal controls transmission of data to the host.
- Enable CTS Scan Control — The CTS line must be active for scanner to read and transmit data. While the CTS line is inactive, scanner remains in a host- disabled state; following a successful label transmission, the CTS signal must transition to inactive and then to active to enable scanning for the next label.
- Enable Magellan SL CTS Scan Control — Follows the same hardware protocol as older Magellan SL scanners.

1. Scan the Enter/Exit Programming Mode bar code.
2. Scan bar code below or from the following page for the desired setting. You'll need to cover any unused bar codes on facing pages to ensure that the scanner reads only the bar code you intend to scan.
3. Complete the programming sequence by scanning the Enter/Exit Programming Mode bar code.



★RS-232 Hardware Control = Disable



RS-232 Hardware Control = Enable CTS Flow Control



RS-232 Parity = Enable CTS Scan Control



RS-232 Hardware Control = Enable MGL SL CTS Scan
Control



RS-232 Intercharacter Delay

Specifies delay between the end of one character and the beginning of the next in 10-millisecond increments.

To set the RS-232 Intercharacter Delay:

1. Scan the Enter/Exit Programming Mode bar code.
2. Scan the bar code below, [Set RS-232 Intercharacter Delay](#). You'll need to cover any unused bar codes on this and the facing page to ensure that the scanner reads only the bar code you intend to scan.
3. Scan the appropriate digits from the [Keypad](#) in [Appendix C](#) that represent the desired delay. The selectable range is 0-100, which is the delay in 10-millisecond increments. Pad all single and double digit numbers with leading zeroes to yield a three-digit entry (000-100).

Examples:

001 = 10ms

005 = 50ms

040 = 400ms

100 = 1,000ms (1 second)

4. The scanner will automatically exit Programming Mode when the appropriate amount of digits have been scanned.



Set RS-232 Intercharacter Delay

★ Default setting for this feature is:

00 - No Intercharacter Delay

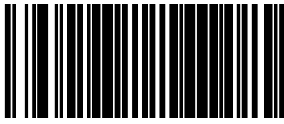

RS-232 Software Flow Control

Enables/disables RS-232 Flow Control using XON/ XOFF characters.



NOTE: This item will be ignored when the feature, RS-232 NAK Character, is enabled

To set this feature:

1. Scan the Enter/Exit Programming Mode bar code.
2. Scan either the enable or disable bar code below. You'll need to cover any unused bar codes on this and the facing page to ensure that the scanner reads only the bar code you intend to scan.
3. Complete the programming sequence by scanning the Enter/Exit Programming Mode bar code.



★ RS-232 Software Flow Control= Disable

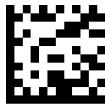

RS-232 Software Flow Control= Enable



RS-232 Ignore Host Commands

When set to ignore host commands, the scanner will ignore all host commands except for the minimum set necessary to keep the interface active, transmit labels, and transmit scale information. For normal operation of the interface, disable this feature.

To set this feature:

1. Scan the Enter/Exit Programming Mode bar code.
2. Scan your selection from the bar codes below. You'll need to cover any unused bar codes on this and the facing page to ensure that the scanner reads only the bar code you intend to scan.
3. Complete the programming sequence by scanning the Enter/Exit Programming Mode bar code.



RS-232 Ignore Host Commands = Don't Ignore



★ RS-232 Ignore Host Commands = Ignore



RS-232 TTL

Specifies whether RS-232 interface provides TTL levels on the output pins TxD and RTS.

Choices are:

- Normal RS-232 levels
- TTL levels

To set this feature:

1. Scan the Enter/Exit Programming Mode bar code.
2. Scan the bar code below which represents the desired setting for this feature. You'll need to cover any unused bar codes on this and the facing page to ensure that the scanner reads only the bar code you intend to scan.
3. Complete the programming sequence by scanning the Enter/Exit Programming Mode bar code.



★RS-232 TTL = Normal RS-232 levels



RS-232 TTL = TTL Levels

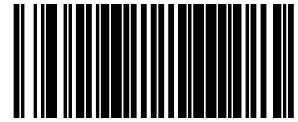

RS-232 TTL Invert

Enables/disables inversion of TTL.

To set this feature:

1. Scan the Enter/Exit Programming Mode bar code.
2. Scan the bar code below which represents the desired setting for this feature. You'll need to cover any unused bar codes on this and the facing page to ensure that the scanner reads only the bar code you intend to scan.
3. Complete the programming sequence by scanning the Enter/Exit Programming Mode bar code.



★RS-232 TTL Invert = Disable



RS-232 TTL Invert = Enable



RS-232 Beep on ASCII BEL

Enables/disables ability of scanner to beep (sound a good read tone) on receiving an ASCII BEL (07 hex).

- Disable
- Enable

To enable/disable this feature:

1. Scan the Enter/Exit Programming Mode bar code.
2. Scan either the enable or disable bar code below. You'll need to cover any unused bar codes on this and the facing page to ensure that the scanner reads only the bar code you intend to scan.
3. Complete the programming sequence by scanning the Enter/Exit Programming Mode bar code.



★RS-232 Beep on ASCII BEL = Disable



RS-232 Beep on ASCII BEL = Enable



RS-232 Beep After Weigh



NOTE: This feature does not apply to Adaptive Scale models.

Enables/disables the ability of the scanner to beep after weight data is transmitted to the host. Scale interfaces that support this item are: RS-232 ICL, RS-232 SASI, and RS-232 Single Cable.

To enable/disable the Beep After Weigh feature:

1. Scan the Enter/Exit Programming Mode bar code.
2. Scan either the enable or disable bar code below. You'll need to cover any unused bar codes on this and the facing page to ensure that the scanner reads only the bar code you intend to scan.
3. Complete the programming sequence by scanning the Enter/Exit Programming Mode bar code.



★RS-232 Beep After Weigh = Disable



RS-232 Beep After Weigh = Enable



Beep on Not on File

Select for the host to beep (or not) when a not-on-file condition is detected by the host. This feature is also applicable to single cable RS-232.

Options for this feature are:

- Muted (no beep will sound)
- Low Volume
- Medium Volume
- High Volume

To configure this feature:

1. Scan the Enter/Exit Programming Mode bar code.
2. Scan the bar code for the desired selection below. You'll need to cover any unused bar codes on this and the facing page to ensure that the scanner reads only the bar code you intend to scan.
3. Complete the programming sequence by scanning the Enter/Exit Programming Mode bar code.



RS-232 Beep on Not on File = Muted



★ RS-232 Beep on Not on File = Low Volume



RS-232 Beep on Not on File = Medium Volume



RS-232 Beep on Not on File = High Volume



RS-232 ACK NAK Enable

This enables/disables the ability of the scanner to support the RS-232 ACK/NAK protocol. When configured, the scanner and/or host sends an “ACK” when it receives data properly, and sends “NAK” when the data is in error. Selections for this option are:

- Disable ACK NAK
- Enable for Label Transmission — the scanner expects an ACK/NAK response from the host when a label is sent)
- Enable for Host Acknowledgment — Enabled for Host Commands (the scanner will respond with ACK/NAK when the host sends a command)
- Enable for Label & Host — Enabled for both Label Transmission & Host Command acknowledgment.

To select the option for RS-232 ACK NAK Enable:

1. Scan the Enter/Exit Programming Mode bar code.
2. Scan the desired option from bar codes below and on the following page. You’ll need to cover any unused bar codes on this and the facing page to ensure that the scanner reads only the bar code you intend to scan.
3. Complete the programming sequence by scanning the Enter/Exit Programming Mode bar code.



★ RS-232 ACK NAK = Disable



RS-232 ACK NAK = Enable for Label Transmission



RS-232 ACK NAK = Enable for Host Acknowledgment



RS-232 ACK NAK = Enable for Label & Host



RS-232 ACK Character

This feature specifies which ASCII character will be used as an ACK character.



NOTE: DO NOT set this feature to use previously defined characters such as XON, XOFF or host commands as this will conflict with normal operation of these characters. 8-bit data is not recognized when the feature, RS-232 Number of Data Bits, is set to 7 data bits.

To specify the RS-232 ACK Character:

1. Scan the Enter/Exit Programming Mode bar code.
2. Scan the bar code, SET RS-232 ACK Character below. You'll need to cover any unused bar codes on this and the facing page to ensure the scanner reads only the bar code you intend to scan.
3. Scan the appropriate digits from the [Keypad in Appendix C](#) that represent the hex designation for the desired character. A table containing the ASCII Character Set and their corresponding Hex Values is available in the inside back cover of this manual. ASCII parameters must be input by scanning a pair of hexadecimal digits for the desired character. For example, if ASCII "A" were the desired ACK character, you would scan the digits "4", then "1" (the ASCII corresponding hex value).
4. The scanner will automatically exit Programming Mode when the appropriate amount of digits/characters have been scanned.



Set RS-232 ACK Character

★ Default setting for this feature is:

06 - ACK



RS-232 NAK Character

This feature specifies which ASCII character will be used as a NAK character.



NOTE: DO NOT set this feature to use previously defined characters such as XON, XOFF or host commands as this will conflict with normal operation of these characters. 8-bit data is not recognized when the feature, RS-232 Number of Data Bits, is set to 7 data bits.

To specify the RS-232 NAK Character:

1. Scan the Enter/Exit Programming Mode bar code.
2. Scan the bar code, SET RS-232 NAK Character below. You'll need to cover any unused bar codes on this and the facing page to ensure the scanner reads only the bar code you intend to scan.
3. Scan the appropriate digits from the the [Keypad in Appendix C](#) that represent the hex designation for the desired character. A table containing the ASCII Character Set and their corresponding Hex Values is available in the inside back cover of this manual. ASCII parameters must be input by scanning a pair of hexadecimal digits for the desired character. For example, if ASCII "A" were the desired NAK character, you would scan the digits "4", then "1" (the ASCII corresponding hex value).
4. The scanner will automatically exit Programming Mode when the appropriate amount of digits/characters have been scanned.



Set RS-232 NAK Character

★ Default setting for this feature is:

15 - NAK

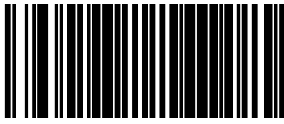

RS-232 Retry on ACK NAK Timeout

This option specifies the action scanner performs on expiration of the RS-232 ACK NAK Timeout Value.

Options are:

- Disable (transmission failure occurs)
- Enable (retry)

To set this feature:

1. Scan the Enter/Exit Programming Mode bar code.
2. Scan either the enable or disable bar code below. You'll need to cover any unused bar codes on this and the facing page to ensure that the scanner reads only the bar code you intend to scan.
3. Complete the programming sequence by scanning the Enter/Exit Programming Mode bar code.



RS-232 Retry on ACK NAK Timeout = Disable



★ RS-232 Retry on ACK NAK Timeout = Enable

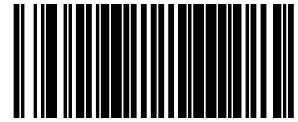

RS-232 ACK NAK Timeout Value

This item specifies the time the scanner will wait for an ACK character from the host following a label transmission.

- 0 = Infinite timeout
- 1 - 75 = Timeout in 200-millisecond increments

To set the ACK NAK Timeout Value:

1. Scan the Enter/Exit Programming Mode bar code.
2. Scan the bar code below, [Set RS-232 ACK NAK Timeout Value](#). You'll need to cover any unused bar codes on this and the facing page to ensure that the scanner reads only the bar code you intend to scan.
3. Scan the appropriate digits from the [Keypad in Appendix C](#) that represent the desired timeout. A setting of 0 specifies an infinite timeout. The remaining selectable range is 1-75, which is the timeout in 200-millisecond increments. Pad all single digit numbers with a leading zero to yield a two-digit entry (00-75).

Examples:

00 = Infinite timeout

01 = 200ms

05 = 1,000ms (1 second)

40 = 8,000ms (8 seconds)

75 = 15,000ms (15 seconds)

The scanner will automatically exit Programming Mode when the appropriate amount of digits have been scanned.



Set RS-232 ACK NAK Timeout Value

★ Default setting for this feature is:

01 - 200ms



RS-232 ACK NAK Retry Count

This feature sets the number of times for the scanner to retry a label transmission under a retry condition.

To set the RS-232 ACK NAK Retry Count:

1. Scan the Enter/Exit Programming Mode bar code.
2. Scan the bar code, [Set RS-232 ACK NAK Retry Count](#) below. You'll need to cover any unused bar codes on this and the facing page to ensure that the scanner reads only the bar code you intend to scan.
3. Scan the appropriate digits from the [Keypad](#) in [Appendix C](#) that represent the desired number. The selectable range is 000-255 resets. Pad all single and double digit numbers with leading zeroes to yield a three-digit entry (000-255).



NOTE: A setting of 255 specifies "retry forever."

4. The scanner will automatically exit Programming Mode when the appropriate amount of digits have been scanned.



Set RS-232 ACK NAK Retry Count

★ Default setting for this feature is:
003 - Three retrys

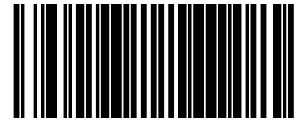

RS-232 ACK NAK Error Handling

This item specifies the method the scanner will use to handle errors detected while waiting to receive the ACK character from the host. Errors include unrecognized host commands and communication errors such as parity or framing errors.

- Ignore Errors (recommended setting)
- Assume ACK (risk of lost label data)
- Assume NAK (risk of duplicate label)

To select the option for RS-232 ACK NAK Error Handling:

1. Scan the Enter/Exit Programming Mode bar code.
2. Scan the desired option from the bar codes below. You'll need to cover any unused bar codes on this and the facing page to ensure that the scanner reads only the bar code you intend to scan.
3. Complete the programming sequence by scanning the Enter/Exit Programming Mode bar code.



★ RS-232 ACK NAK Error Handling = Ignore Errors



RS-232 ACK NAK Error Handling = Assume ACK



RS-232 ACK NAK Error Handling = Assume NAK



RS-232 Indicate Transmission Failure

This feature enables / disables the ability of the scanner to sound a bad label beep indication when a transmission failure occurs.

To set this feature:

1. Scan the Enter/Exit Programming Mode bar code.
2. Scan the desired option from the bar codes below. You'll need to cover any unused bar codes on this and the facing page to ensure that the scanner reads only the bar code you intend to scan.
3. Complete the programming sequence by scanning the Enter/Exit Programming Mode bar code.



RS-232 Indicate Transmission Failure = Disable



★ RS-232 Indicate Transmission Failure = Enable

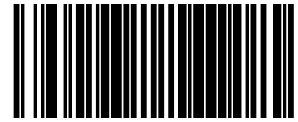

SINGLE CABLE RS-232 OPTIONS

The RS-232 Single Cable interface shares some configuration options with other RS-232 interfaces. Rather than repeat them in this section as Single Cable options, please find them referenced as follows:

- "RS-232 Baud Rate" on page 175
- "RS-232 Number of Data Bits" on page 177
- "RS-232 Number of Stop Bits" on page 178
- "RS-232 Parity" on page 179
- "RS-232 Software Flow Control" on page 182
- "RS-232 Beep After Weigh" on page 187
- "Beep on Not on File" on page 188

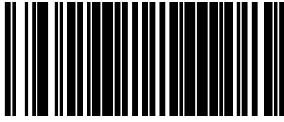

Single Cable RS-232 Scanner Only Protocol

This sets the type of interface protocol that will be used in Single Cable RS-232.

Options are:

- Scanner/scale RS-232 protocol
- Scanner only RS-232 protocol

To set this feature:

1. Scan the Enter/Exit Programming Mode bar code.
2. Scan the bar code below representing the desired option. You'll need to cover any unused bar codes on this and the facing page to ensure that the scanner reads only the bar code you intend to scan.
3. Complete the programming sequence by scanning the Enter/Exit Programming Mode bar code.



★ Single Cable RS-232 Scanner Only Protocol = Scanner/scale RS-232 protocol



Single Cable RS-232 Scanner Only Protocol = Scanner Only protocol



Single Cable RS-232 RTS CTS Selection

Specifies how RTS and CTS are used to control the data flow. RTS is controlled by the Scanner and can be continuously held high/low, or can be asserted during label transmission. The scanner looks at CTS, as the configuration values state, to determine when to send label data.

Choices are:

- Option 0 = RTS is held in low state and CTS is ignored
- Option 1 = RTS is held in high state and CTS is ignored
- Option 2 = Assert RTS and wait for CTS to be asserted
- Option 3 = Assert RTS and ignore CTS
- Option 4 = RTS held low, wait for CTS to be asserted
- Option 5 = RTS held high, wait for CTS to be asserted

To set this feature:

1. Scan the Enter/Exit Programming Mode bar code.
2. Scan a bar code below or on the following pages representing the desired option. You'll need to cover any unused bar codes, as well as facing pages to ensure that the scanner reads only the bar code you intend to scan.
3. Complete the programming sequence by scanning the Enter/Exit Programming Mode bar code.



Single Cable RS-232 RTS CTS Selection = Option 0



Single Cable RS-232 RTS CTS Selection = Option 1



Single Cable RS-232 RTS CTS Selection = Option 2



Single Cable RS-232 RTS CTS Selection = Option 3



Single Cable RS-232 RTS CTS Selection (continued)



Single Cable RS-232 RTS CTS Selection = Option 4

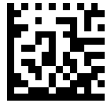

★ Single Cable RS-232 RTS CTS Selection = Option 5



Single Cable RS-232 Use BCC

Enables/disables the ability of the scanner to use BCC (Block Check Character).

To set this feature:

1. Scan the Enter/Exit Programming Mode bar code.
2. Scan either the enable or disable bar code below. You'll need to cover any unused bar codes on this and the facing page to ensure that the scanner reads only the bar code you intend to scan.
3. Complete the programming sequence by scanning the Enter/Exit Programming Mode bar code.



★ Single Cable RS-232 Use BCC = Disable



Single Cable RS-232 Use BCC = Enable



Single Cable RS-232 Use ACK/NAK

Enables/disables the ability of the scanner to use ACK/NAK.

To set this feature:

1. Scan the Enter/Exit Programming Mode bar code.
2. Scan either the enable or disable bar code below. You'll need to cover any unused bar codes on this and the facing page to ensure that the scanner reads only the bar code you intend to scan.
3. Complete the programming sequence by scanning the Enter/Exit Programming Mode bar code.



★ Single Cable RS-232 Use ACK/NAK = Disable



Single Cable RS-232 Use ACK/NAK = Enable

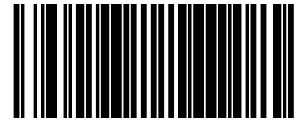

Single Cable RS-232 Use STX

Enables/disables the ability of the scanner to use STX.

To set this feature:

1. Scan the Enter/Exit Programming Mode bar code.
2. Scan either the enable or disable bar code below. You'll need to cover any unused bar codes on this and the facing page to ensure that the scanner reads only the bar code you intend to scan.
3. Complete the programming sequence by scanning the Enter/Exit Programming Mode bar code.



Single Cable RS-232 Use STX = Disable



★ Single Cable RS-232 Use STX = Enable

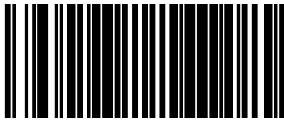

Set Single Cable RS-232 STX Character

This feature selects the STX character.

To specify the STX Character:

1. Scan the Enter/Exit Programming Mode bar code.
2. Scan the bar code, [Set Single Cable RS-232 STX Character](#) below. You'll need to cover any unused bar codes on this and the facing page to ensure the scanner reads only the bar code you intend to scan.
3. Scan the appropriate characters/digits from the [Keypad](#) in [Appendix C](#) that represent the decimal designation for the desired character. A table containing the ASCII Character Set and their corresponding decimal values is available in the inside back cover of this manual. ASCII parameters must be input by scanning decimal digits for each character. Pad all numbers with leading zeroes to yield a three-digit entry (001-127). Thus, to set a single character value of A, bar codes containing the digits '0', '6' and '5' must be scanned. The selectable range for this option is any decimal value from 001 to 127.
4. The scanner will automatically exit Programming Mode when the appropriate amount of digits have been scanned.



Set Single Cable RS-232 STX Character

★ Default setting for this feature is:

053 - S

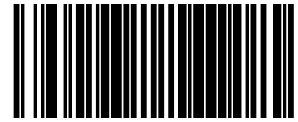

Single Cable RS-232 Use ETX

Enables/disables the ability of the scanner to use ETX.

To set this feature:

1. Scan the Enter/Exit Programming Mode bar code.
2. Scan either the enable or disable bar code below. You'll need to cover any unused bar codes on this and the facing page to ensure that the scanner reads only the bar code you intend to scan.
3. Complete the programming sequence by scanning the Enter/Exit Programming Mode bar code.

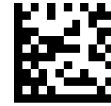

Single Cable RS-232 Use ETX = Disable



★ Single Cable RS-232 Use ETX = Enable

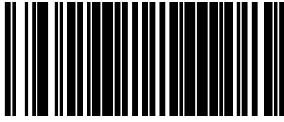

Set Single Cable RS-232 ETX Character

Allows selection of the ETX character.

To specify the ETX Character:

1. Scan the Enter/Exit Programming Mode bar code.
2. Scan the bar code, [Set Single Cable RS-232 ETX Character](#) below. You'll need to cover any unused bar codes on this and the facing page to ensure the scanner reads only the bar code you intend to scan.
3. Scan the appropriate characters/digits from the [Keypad](#) in [Appendix C](#) that represent the decimal designation for the desired character. A table containing the ASCII Character Set and their corresponding decimal values is available in the inside back cover of this manual. ASCII parameters must be input by scanning decimal digits for each character. Pad all numbers with leading zeroes to yield a three-digit entry (001-127). Thus, to set a single character value of A, bar codes containing the digits '0', '6' and '5' must be scanned. The selectable range for this option is any decimal value from 001 to 127.
4. The scanner will automatically exit Programming Mode when the appropriate amount of digits have been scanned.



Set Single Cable RS-232 ETX Character

★ Default setting for this feature is:

00D - CR



Single Cable RS-232 Datalogic Extensions

When Datalogic extensions are enabled, scale calibration mode information is communicated to the host. Contact Customer Support for the format of this information. Choices for this feature are:

- Standard Protocol
- Support Datalogic Extensions to Protocol

To set this feature:

1. Scan the Enter/Exit Programming Mode bar code.
2. Scan your selection from the bar codes below. You'll need to cover any unused bar codes on this and the facing page to ensure that the scanner reads only the bar code you intend to scan.
3. Complete the programming sequence by scanning the Enter/Exit Programming Mode bar code.



★ Single Cable RS-232 Datalogic Extensions = Standard Protocol



Single Cable RS-232 Datalogic Extensions = Support Datalogic Extensions to Protocol



Single Cable RS-232 Pacesetter Plus

This option enables the scanner's ability to send Pacesetter Plus information as trailers to UPC/EAN bar codes.

To set this feature:

1. Scan the Enter/Exit Programming Mode bar code.
2. Scan your selection from the bar codes below. You'll need to cover any unused bar codes on this and the facing page to ensure that the scanner reads only the bar code you intend to scan.
3. Complete the programming sequence by scanning the Enter/Exit Programming Mode bar code.



★ Single Cable RS-232 Pacesetter Plus = Do Not Send



Single Cable RS-232 Pacesetter Plus = Send

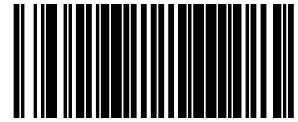

USB KEYBOARD AND KEYBOARD WEDGE FEATURES

USB Keyboard and Keyboard Wedge Intercharacter Delay

Specifies a time delay between characters.

To set this feature:

1. Scan the [USB Keyboard and Keyboard Wedge Intercharacter Delay](#) bar code.
2. Scan the appropriate characters/digits from the [Keypad](#) in [Appendix C](#) that represent the desired delay. The selectable range for this option is any decimal value from 00 (no delay) to 99 in 10 ms increments. A table containing the ASCII Character Set and their corresponding decimal values is available in the inside back cover of this manual. ASCII parameters must be input by scanning decimal digits for each character. Pad all single digit numbers with leading zero to yield a two-digit entry (00-99). Thus, to set an intercharacter delay of 70ms, bar codes containing the digits '0' and '7' must be scanned.
3. Complete the programming sequence by scanning the Enter/Exit Programming Mode bar code.



Set USB Keyboard/Keyboard Wedge Intercharacter
Delay

★ Default setting for this feature is: 01 (10ms)



Keyboard Wedge No Keyboard Support

Enables the scanner to perform host communications normally performed by an attached keyboard.

To set this feature:

1. Scan the Enter/Exit Programming Mode bar code.
2. Scan either the enable or disable bar code below. You'll need to cover any unused bar codes on this and the facing page to ensure that the scanner reads only the bar code you intend to scan.
3. Complete the programming sequence by scanning the Enter/Exit Programming Mode bar code.



★ Keyboard Wedge No Keyboard Support = Disable



Keyboard Wedge No Keyboard Support = Enable

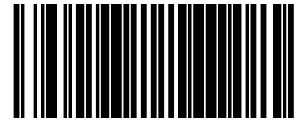

USB Keyboard and Keyboard Wedge Send Control Characters

This feature specifies how the scanner transmits ASCII control characters to the host.



NOTE: Affects suffix and prefix characters. When disabled, only ASCII characters between 20H and 127H inclusive (space... delete) plus special characters 0DH (carriage return), 08H (backspace), 27H (ESC), 09H (right tab) and 0BH (left tab) are transmitted.

Choices are:

Disable: No control characters are sent to the host.

Enable transmission of control characters to host: Control characters are sent to the host.

Send characters between 00H and 1FH: Send characters between 00H and 1FH according to special function-key mapping table (This is used to send keys that are not in normal ASCII set; a unique set is provided for each available scancode set)

To set this feature:

1. Scan the Enter/Exit Programming Mode bar code.
2. Scan the bar code for the desired setting below. You'll need to cover any unused bar codes on this and the facing page to ensure that the scanner reads only the bar code you intend to scan.
3. Complete the programming sequence by scanning the Enter/Exit Programming Mode bar code.



★ Keyboard Send Control Characters = Disable



Keyboard Send Control Characters =
Enable transmission of control characters to host



USB Keyboard/Keybd Wedge No Keyboard Support =
Send characters between 00H and 1FH



USB Keyboard and Keyboard Wedge Country Mode

This feature specifies the country/language that will be supported by the keyboard.



★ USB Keyboard and Keyboard Wedge Country Mode =
USA

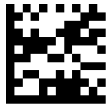

USB Keyboard and Keyboard Wedge Country Mode =
Belgium



USB Keyboard and Keyboard Wedge Country Mode =
Britain



USB Keyboard and Keyboard Wedge Country Mode =
Denmark



USB Keyboard and Keyboard Wedge Country Mode =
France



USB Keyboard and Keyboard Wedge Country Mode =
Germany



USB Keyboard and Keyboard Wedge Country Mode (continued)



USB Keyboard and Keyboard Wedge Country Mode =
Italy



USB Keyboard and Keyboard Wedge Country Mode =
Norway



USB Keyboard and Keyboard Wedge Country Mode =
Portugal



USB Keyboard and Keyboard Wedge Country Mode =
Spain



USB Keyboard and Keyboard Wedge Country Mode =
Sweden



USB Keyboard and Keyboard Wedge Country Mode =
Switzerland



USB Keyboard and Keyboard Wedge Country Mode (continued)



USB Keyboard and Keyboard Wedge Country Mode =
Japanese 106-key



USB Keyboard and Keyboard Wedge Country Mode =
Hungary



USB Keyboard and Keyboard Wedge Country Mode =
Czech Republic



USB Keyboard and Keyboard Wedge Country Mode =
Slovakia



USB Keyboard and Keyboard Wedge Country Mode =
Romania



USB Keyboard and Keyboard Wedge Country Mode =
Croatia



USB Keyboard and Keyboard Wedge Country Mode =
Poland

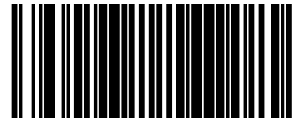

USB Keyboard and Keyboard Wedge Country Mode (continued)



USB Keyboard and Keyboard Wedge Country Mode =
French Canadian



USB Keyboard and Keyboard Wedge Country Mode =
Turkish



Keyboard Wedge Quiet Interval

This setting specifies the amount of time to monitor for keyboard activity before breaking the keyboard connection.

To set this feature:

1. Scan the Enter/Exit Programming Mode bar code.
2. Scan the bar code, [Keyboard Wedge Quiet Interval](#). You'll need to cover any unused bar codes on this and the facing page to ensure that the scanner reads only the bar code you intend to scan.
3. Scan the appropriate digits from the [Keypad](#) in [Appendix C](#) that represent the desired time interval. The selectable range is 001-100, which is the interval in 10-millisecond increments. Pad all single and double digit numbers with leading zeroes to yield a three-digit entry (001-100).

Examples:

001 = 10ms

005 = 50ms

040 = 400ms

100 = 1,000ms (1 second)

4. The scanner will automatically exit Programming Mode when the appropriate amount of digits have been scanned.



Set Keyboard Wedge Quiet Interval

★ Default setting for this feature is:

00A - 100ms

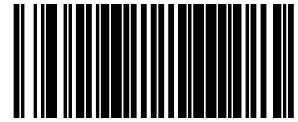

USB Keyboard and Keyboard Wedge Caps Lock State

This feature specifies the format in which the scanner sends character data. Selections are:

Caps Lock OFF: Send character data in normal format

Caps Lock ON: Send character data in reverse case

Shift Lock Mode: Send character data in shifted case. This only applies to Wedge G. For other interfaces, this setting results in a Caps Lock OFF functionality.

Caps Lock Compensation Mode: This only applies to USB Keyboard. For other interfaces, this setting results in a Caps Lock OFF functionality.

1. Scan the Enter/Exit Programming Mode bar code.
2. Scan the desired selection from the bar codes below. You'll need to cover any unused bar codes on this and the facing page to ensure that the scanner reads only the bar code you intend to scan.
3. Complete the programming sequence by scanning the Enter/Exit Programming Mode bar code.

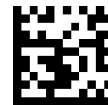

★ USB Keyboard and Keyboard Wedge Caps Lock State = Caps Lock OFF



USB Keyboard and Keyboard Wedge Caps Lock State = Caps Lock ON



USB Keyboard and Keyboard Wedge Caps Lock State = Shift Lock Mode



USB Keyboard and Keyboard Wedge Caps Lock State = Caps Lock Comensation

NOTES

DATA EDITING

SECTION CONTENTS	
DATA EDITING OVERVIEW starting on page 220	
CASE CONVERSION starting on page 221	
CHARACTER CONVERSION starting on page 222	
GLOBAL PREFIX/SUFFIX starting on page 223	
<ul style="list-style-type: none">• Global Prefix	Global Suffix
GLOBAL AIM ID ENABLE starting on page 225	
LABEL ID CONTROL starting on page 226	
<ul style="list-style-type: none">• Setting Label ID• 1D Symbologies	<ul style="list-style-type: none">• 2D Symbologies• Global Mid-Label ID



DATA EDITING OVERVIEW



CAUTION: These features are not supported by the USB-OEM interface.

When a bar code is scanned, additional information can be sent to the host computer along with the bar code data. This combination of bar code data and supplementary user-defined data is called a “message string.” The features in this chapter can be used to build specific user-defined data into a message string.

There are several types of selectable data characters that can be sent before and after scanned data. You can specify if they should be sent with all symbologies, or only with specific symbologies. Figure 1 shows the available elements you can add to a message string.

Figure 1. Breakdown of a Message String

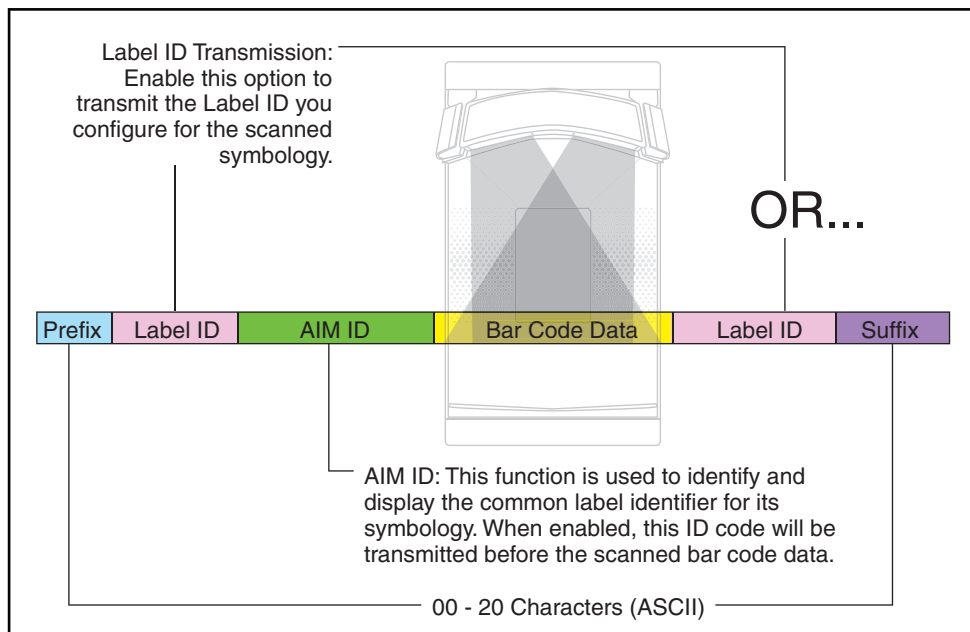

Additional data editing options include the features [Case Conversion](#) and [Character Conversion](#).



Please Keep In Mind...

- Modifying a message string is not a mandatory requirement. Data editing is a sophisticated feature allowing highly customizable output for advanced users. Factory default settings for data editing is typically set to NONE.
- A prefix or suffix may be applied (reference the [1D Symbology Programming](#) or [2D Symbology Programming](#) chapter for these settings) across all symbologies (set via the Global features in this chapter).
- You can add any character from the [ASCII Character Set](#) (from 00-7F) on the inside back cover of this manual as a prefix, suffix or Label ID.
- Enter prefixes and suffixes in the order in which you want them to appear on the output.

CASE CONVERSION

This option can change the case of all alphabetic characters to upper or lower case.

To set this feature:

1. Scan the Enter/Exit Programming Mode bar code.
2. Scan bar code for the desired option below. You'll need to cover any unused bar codes on this and the facing page to ensure that the scanner reads only the bar code you intend to scan.
3. Complete the programming sequence by scanning the Enter/Exit Programming Mode bar code.



★ Case Conversion = No Case Conversion



Case Conversion = Upper Case



Case Conversion = Lower Case



CHARACTER CONVERSION

Character conversion is an 8-byte configuration item. The 8 bytes are 4-character pairs represented in hexadecimal ASCII values. The first character in the pair is the character to be converted, the second character is the character to convert to. If the character to convert in a pair is FF, then no conversion is done.

For example, if you have the character conversion configuration item set to the following:

41423132FFFFFFFF

The first pair is 4142 or AB (41 hex is an ASCII capital A, 42 hex is an ASCII capital B) and the second pair is 3132 or 12 (31 hex is an ASCII 1, 32 is an ASCII 2). The other two pairs are FFFF and FFFF.

With the label, AG15TA81, it would look as follows after the character conversion: BG25TB82.

The A characters were converted to the B character and the 1 characters were converted to the numeral 2 character. Nothing is done with the last two character pairs, since they are all FF.

To set Character Conversion:

1. Scan the Enter/Exit Programming Mode bar code.
2. Scan the Character Conversion bar code.
3. Determine the desired string. Up to 16 positions can be determined as shown above. Next, turn to the ASCII Chart on the inside back cover of this manual and find the equivalent hex digits needed to fulfill the string.



NOTE: The positions not used must be filled with the character 'F'.

4. Turn to the [Keypad](#) in [Appendix C](#) and scan the bar codes representing the hex characters determined in the previous step. When the last character is scanned, the scanner will sound a triple beep.
5. Complete the programming sequence by scanning the Enter/Exit Programming Mode bar code.



Set Character Conversion

★ Default setting for this feature is:

FFFFFFFFFFFFFFFF (No Character Conversion)



GLOBAL PREFIX/SUFFIX

Global Prefix

This feature applies to RS-232 interfaces (Standard, Wincor-Nixdorf, and Single Cable). It specifies the prefix that is added to beginning of label transmission.

1. Scan the Enter/Exit Programming Mode bar code.
2. Scan the bar code, [Set Global Prefix](#) below. You'll need to cover any unused bar codes to ensure the scanner reads only the bar code you intend to scan.
3. Scan the appropriate characters/digits from the [Keypad](#) that represent the hex designation for the desired character(s). A table containing the ASCII Character Set and their corresponding Hex Values is available in the inside back cover of this manual. ASCII parameters must be input by scanning a pair of hexadecimal digits for each character. Thus, to set a two-character value of AB, bar codes containing the digits '4', '1', '4', and '2' must be scanned. The selectable range for this option is any hex value from 00 to FF. Up to 20 hex pairs can be designated.



NOTE: To specify "no Global Prefix," scan 00.

4. If designating the full 20 hex pairs, the scanner will automatically exit Programming Mode when the appropriate amount of digits have been scanned. If designating less than 20 hex pairs, you can end the programming sequence early by scanning the [Terminate Sequence](#) bar code.
5. Complete the programming sequence by scanning the Enter/Exit Programming Mode bar code.



Set Global Prefix



Terminate Sequence

★ Default setting for this feature is:
00 - No Global Prefix



Global Suffix

This feature applies to RS-232 interfaces (Standard, Wincor-Nixdorf, and Single Cable). It specifies the suffix that is added to end of a label transmission. Three standard options are available below. Contact your dealer for other alternate settings for this feature.

- No Global Suffix
- CR — Carriage Return
- CR LF — Carriage Return, Line Feed

To set the Global Suffix:

1. Scan the Enter/Exit Programming Mode bar code.
2. Scan your selection from the bar codes below.
3. Complete the programming sequence by scanning the Enter/Exit Programming Mode bar code.



Global Suffix = No Global Suffix



★ Global Suffix = CR



Global Suffix = CR LF



GLOBAL AIM ID ENABLE

This option enables or disables the addition of the AIM ID to all bar code types except for EAN 128.

To set this option:

1. Scan the Enter/Exit Programming Mode bar code.
2. Scan either the enable or disable bar code below. You'll need to cover any unused bar codes on this and the facing page to ensure that the scanner reads only the bar code you intend to scan.
3. Complete the programming sequence by scanning the Enter/Exit Programming Mode bar code.



★ Global AIM ID = Disable



Global AIM ID = Enable



LABEL ID

Label ID Control

This feature specifies whether or not Label IDs are transmitted to the host and if so, whether to attach them as a prefix or suffix.

Choices are:

- Disable
- Enable as a Prefix
- Enable as a Suffix

To select the option for Label ID Control:

1. Scan the Enter/Exit Programming Mode bar code.
2. Scan the desired option from the bar codes below. You'll need to cover any unused bar codes on this and the facing page to ensure that the scanner reads only the bar code you intend to scan.
3. Complete the programming sequence by scanning the Enter/Exit Programming Mode bar code.



Label ID Control = Disable



★ Label ID Control = Enable as a Prefix



Label ID Control = Enable as a Suffix

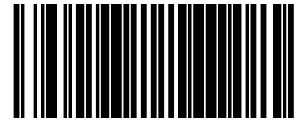

Setting Label ID

This feature allows the setting of custom Label ID character(s) for each available symbology type if other than the default Label ID is desired.

To set this feature:

1. Scan the Enter/Exit Programming Mode bar code.
2. Scan the bar code for the desired symbology below. You'll need to cover any unused bar codes on this and the facing page to ensure the scanner reads only the bar code you intend to scan.
3. Scan the appropriate digits from the [Keypad](#) in [Appendix C](#) that represent the desired Label ID characters; entered as two hex pairs. A table containing the ASCII Character Set and their corresponding Hex Values is available in the inside back cover of this manual. ASCII parameters must be input by scanning a pair of hexadecimal digits for each character. Thus, to set a two-character value of AB, bar codes containing the digits '4', '1', '4', and '2' must be scanned. The selectable range for this option is any hex value from 00 to FF.

Complete the programming sequence by scanning the Enter/Exit Programming Mode bar code.

1D Symbologies

Default Label ID for this symbology is:
41 = A



Set UPC-A Label ID



Set UPC-A 2-Digit Supplemental Label ID

Default Label ID for this symbology is:
41 = A



Set UPC-A 5-Digit Supplemental Label ID

Default Label ID for this symbology is:
41 = A



Set UPC-E Label ID

Default Label ID for this symbology is:
45 = E



Setting Label ID (continued)

Default Label ID for this symbology is:
45 = E



Set UPC-E 2-Digit Supplemental Label ID



Set UPC-E 5-Digit Supplemental Label ID

Default Label ID for this symbology is:
45 = E

Default Label ID for this symbology is:
46 = F

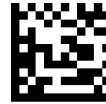

Set EAN-13 Label ID



Set EAN-13 2-Digit Supplemental Label ID

Default Label ID for this symbology is:
46 = F

Default Label ID for this symbology is:
46 = F



Set EAN-13 5-Digit Supplemental Label ID



Set EAN-8 Label ID

Default Label ID for this symbology is:
4646 = FF

Default Label ID for this symbology is:
4646 = FF



Set EAN-8 2-Digit Supplemental Label ID

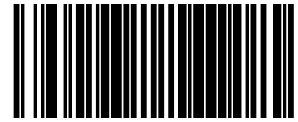

Setting Label ID (continued)



Set EAN-8 5-Digit Supplemental Label ID

Default Label ID for this symbology is:
4646 = FF

Default Label ID for this symbology is:
47 = G



Set GTIN Label ID

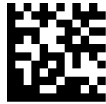

Set GTIN 2-Digit Supplemental Label ID

Default Label ID for this symbology is:
4732 = G2

Default Label ID for this symbology is:
4735 = G5



Set GTIN 5-Digit Supplemental Label ID



Set GTIN Code 128 Supplemental Label ID

Default Label ID for this symbology is:
4738 = G8

Default Label ID for this symbology is:
5234 = R4



Set DataBar Omnidirectional Label ID



Set DataBar Omnidirectional Composite Label ID

Default Label ID for this symbology is:
5234 = R4



Setting Label ID (continued)

Default Label ID for this symbology is:
5258 = RX



Set DataBar Expanded Label ID



Set DataBar Expanded Composite Label ID

Default Label ID for this symbology is:
524C = RL



Set DataBar Limited Label ID



Set DataBar Limited Composite Label ID

Default Label ID for this symbology is:
2A = *



Code 39 Label ID



Code 32 Label ID

Default Label ID for this symbology is:
41 = A



Code 128 Label ID

Default Label ID for this symbology is:
23 = #



EAN 128 Label ID

Default Label ID for this symbology is:
50 = P



Setting Label ID (continued)

Default Label ID for this symbology is:
69 = i



1 2 of 5 Label ID



Codabar Label ID

Default Label ID for this symbology is:
25 = %



Code 93 Label ID

Default Label ID for this symbology is:
26 = &



MSI Label ID

Default Label ID for this symbology is:
40 = @



Standard 2 of 5 Label ID

Default Label ID for this symbology is:
73 = s



ISBN Label ID

Default Label ID for this symbology is:
49 = l



2D Symbolologies

Default Label ID for this symbology is:
446D = Dm



Data Matrix Label ID



PDF 417 Label ID

Default Label ID for this symbology is:
50 = P



Micro PDF 417 Label ID

Default Label ID for this symbology is:
6D50 = mP



QR Code Label ID

Default Label ID for this symbology is:
5152 = QR



Micro QR Code Label ID

Default Label ID for this symbology is:
2451 = \$Q



Aztec Label ID

Default Label ID for this symbology is:
417A = Az



GS1 Datamatrix label ID

Default Label ID for this symbology is:
4467 = Dg



GS1 QR Code label ID

Default Label ID for this symbology is:
5147 = QG

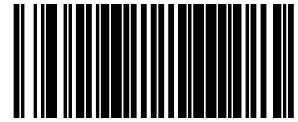

GLOBAL MID-LABEL ID

This feature specifies a global mid-label ID that is added between two bar codes for transmission.

To set this feature:

1. Scan the Enter/Exit Programming Mode bar code.
2. Scan the [Set Global Mid-Label ID](#) bar code below. You'll need to cover any unused bar codes on this and the facing page to ensure the scanner reads only the bar code you intend to scan.
3. Scan the appropriate digits from the [Keypad](#) in [Appendix C](#) that represent the desired mid-label ID characters; entered as two hex pairs. A table containing the ASCII Character Set and their corresponding Hex Values is available in the inside back cover of this manual. ASCII parameters must be input by scanning a pair of hexadecimal digits for each character. Thus, to set a two-character value of AB, bar codes containing the digits '4', '1', '4', and '2' must be scanned. The selectable range for this option is any hex value from 00 to FF.

Complete the programming sequence by scanning the Enter/Exit Programming Mode bar code.



Set Global Mid-Label ID

★ Default Label ID for this symbology is:

00 = No Global Mid-label ID

NOTES



1D SYMBOLOGY PROGRAMMING

1D SYMBOLOGIES



NOTE: If the scanner’s interface type must be changed, always be sure that interface configuration is the **FIRST** item scanned during a programming session. (Selecting an interface type resets **ALL** other configuration items — including symbology programming — to the factory default for that interface type.)

The following pages contain configuration information concerning the various bar code types (symbologies) the scanner supports.

SECTION CONTENTS	
COUPON CONTROL starting on page 236	DATABAR EXPANDED ENABLE starting on page 293
UPC-A starting on page 237	CODE 39 ENABLE starting on page 305
UPC-E ENABLE starting on page 243	CODE 32 ITALIAN PHARMACODE ENABLE starting on page 317
EAN-13 ENABLE starting on page 249	CODE 128 ENABLE starting on page 320
EAN-8 starting on page 254	EAN-128 ENABLE starting on page 329
OTHER UPC/EAN OPTIONS starting on page 266	INTERLEAVED 2 OF 5 (I 2 OF 5) ENABLE starting on page 330
GTIN ENABLE starting on page 287	CODABAR ENABLE starting on page 339
GS1 DATABAR starting on page 288	CODE 93 ENABLE starting on page 352
DATABAR OMNIDIRECTIONAL ENABLE starting on page 288	MSI ENABLE starting on page 359
DATABAR LIMITED starting on page 301	STANDARD 2 OF 5 ENABLE starting on page 369



Coupon Control

This feature is used to control the method of processing coupon labels. For the purposes of this feature, coupon labels are defined as:

1. UPC-A labels that start with a '5'
2. GS1 DataBar Expanded labels that start with '8110'

The options for this setting are:

- Disable — Coupon Control is turned off.
- Enable UPC-A Coupons — UPC-A coupon labels will decode but GS1 DataBar Expanded coupon labels will not. GS1 DataBar Expanded labels that are not coupon labels will decode and all UPC-A labels will decode.
- Enable GS1 DataBar Expanded Coupons — GS1 DataBar Expanded coupon labels will decode but UPC-A coupon labels will not. UPC-A labels that are not coupon labels will decode and all GS1 DataBar Expanded labels will decode.

To set this feature:

1. Scan the Enter/Exit Programming Mode bar code.
2. Scan your choice from the Coupon Control selections below. Cover any unused bar codes on this and the facing page so the scanner reads only the bar code you intend to scan.
3. Complete the programming sequence by scanning the Enter/Exit Programming Mode bar code.



Coupon Control = Disable



★ Coupon Control = Enable UPC-A Coupons



Coupon Control = Enable GS1 DataBar Expanded Coupons

Coupon Label Priority Timer

This feature sets the duration of the UPCA / DataBar coupon label priority timer.



To set this feature:

1. Scan the Enter/Exit Programming Mode bar code.
2. Scan your selection from the bar codes below. You'll need to cover any unused bar codes on this and the facing page to ensure that the scanner reads only the bar code you intend to scan.
3. Complete the programming sequence by scanning the Enter/Exit Programming Mode bar code.



Coupon Label Priority Timer = 0.1 Seconds



★ Coupon Label Priority Timer = 0.2 Seconds



Coupon Label Priority Timer = 0.3 Seconds



Coupon Label Priority Timer = 0.4 Seconds



Coupon Label Priority Timer = 0.5 Second



Coupon Label Priority Timer = 1 Second

UPC-A

- [UPC-A Number System Character Transmission](#)



- UPC-A Check Character Transmission
- UPC-A Minimum Read
- Expand UPC-A to EAN-13

UPC-A Enable

Enables/disables the ability of the scanner to decode UPC-A labels.

To set this feature:

1. Scan the Enter/Exit Programming Mode bar code.
2. Scan either the enable or disable bar code below. You'll need to cover any unused bar codes on this and the facing page to ensure that the scanner reads only the bar code you intend to scan.
3. Complete the programming sequence by scanning the Enter/Exit Programming Mode bar code.



UPC-A = Disable



★UPC-A = Enable



UPC-A Number System Character Transmission

Enables/disables transmission of a UPC-A number system character.



NOTE: This feature MUST be enabled for IBM interfaces for proper function. This item is ignored when the advanced feature, Full Label Edit, is enabled.

To set this feature:

1. Scan the Enter/Exit Programming Mode bar code.
2. Scan either the enable or disable bar code below. You'll need to cover any unused bar codes on this and the facing page to ensure that the scanner reads only the bar code you intend to scan.
3. Complete the programming sequence by scanning the Enter/Exit Programming Mode bar code.



UPC-A Number System Character Transmission =
Disable



★ UPC-A Number System Character Transmission =
Enable



UPC-A Check Character Transmission

Enables/disables transmission of a UPC-A check character.



NOTE: This item is ignored when the advanced feature, Full Label Edit, is enabled.

To set this feature:

1. Scan the Enter/Exit Programming Mode bar code.
2. Scan either the enable or disable bar code below. You'll need to cover any unused bar codes on this and the facing page to ensure that the scanner reads only the bar code you intend to scan.
3. Complete the programming sequence by scanning the Enter/Exit Programming Mode bar code.



UPC-A Check Character Transmission = Disable



★ UPC-A Check Character Transmission = Enable



UPC-A Minimum Read

This feature specifies the minimum number of consecutive UPC-A decodes before is accepted as good read.

To set this feature:

1. Scan the ENTER/EXIT Programming Mode bar code.
2. Scan your selection from the bar codes below. You'll need to cover any unused bar codes on this and the facing page to ensure that the scanner reads only the bar code you intend to scan.
3. Complete the programming sequence by scanning the ENTER/EXIT Programming Mode bar code.



★ UPC-A Minimum Read = 1



UPC-A Minimum Read = 2



UPC-A Minimum Read = 3



UPC-A Minimum Read = 4



Expand UPC-A to EAN-13

Enables/disables expansion of UPC-A labels to EAN/JAN-13.

To set this feature:

1. Scan the Enter/Exit Programming Mode bar code.
2. Scan either the enable or disable bar code below. You'll need to cover any unused bar codes on this and the facing page to ensure that the scanner reads only the bar code you intend to scan.
3. Complete the programming sequence by scanning the Enter/Exit Programming Mode bar code.



★ Expand UPC-A to EAN-13 = Disable



Expand UPC-A to EAN-13 = Enable



UPC-E ENABLE

Enables/disables the ability of the scanner to decode UPC-E labels.

To set this feature:

1. Scan the Enter/Exit Programming Mode bar code.
2. Scan either the enable or disable bar code below. You'll need to cover any unused bar codes on this and the facing page to ensure that the scanner reads only the bar code you intend to scan.
3. Complete the programming sequence by scanning the Enter/Exit Programming Mode bar code.



UPC-E = Disable



★UPC-E = Enable



UPC-E Number System Character Transmission

Enables/disables transmission of a UPC-E number system character.



NOTE: This item is ignored when the advanced feature, Full Label Edit, is enabled.

To set this feature:

1. Scan the Enter/Exit Programming Mode bar code.
2. Scan either the enable or disable bar code below. You'll need to cover any unused bar codes on this and the facing page to ensure that the scanner reads only the bar code you intend to scan.
3. Complete the programming sequence by scanning the Enter/Exit Programming Mode bar code.



UPC-E Number System Character Transmission =
Disable



★ UPC-E Number System Character Transmission =
Enable



UPC-E Check Character Transmission

Enables/disables transmission of a UPC-E check character.



NOTE: This item is ignored when the advanced feature, Full Label Edit, is enabled.

To set this feature:

1. Scan the Enter/Exit Programming Mode bar code.
2. Scan either the enable or disable bar code below. You'll need to cover any unused bar codes on this and the facing page to ensure that the scanner reads only the bar code you intend to scan.
3. Complete the programming sequence by scanning the Enter/Exit Programming Mode bar code.



UPC-E Check Character Transmission = Disable



★ UPC-E Check Character Transmission = Enable



Expand UPC-E to UPC-A

Enables/disables expansion of UPC-E labels to UPC-A.

To set this feature:

1. Scan the Enter/Exit Programming Mode bar code.
2. Scan either the enable or disable bar code below. You'll need to cover any unused bar codes on this and the facing page to ensure that the scanner reads only the bar code you intend to scan.
3. Complete the programming sequence by scanning the Enter/Exit Programming Mode bar code.



★ Expand UPC-E to UPC-A = Disable



Expand UPC-E to UPC-A = Enable



Expand UPC-E to EAN-13

Enables/disables expansion of UPC-E labels to EAN/JAN-13.

To set this feature:

1. Scan the Enter/Exit Programming Mode bar code.
2. Scan either the enable or disable bar code below. You'll need to cover any unused bar codes on this and the facing page to ensure that the scanner reads only the bar code you intend to scan.
3. Complete the programming sequence by scanning the Enter/Exit Programming Mode bar code.



★ Expand UPC-E to EAN-13 = Disable



Expand UPC-E to EAN-13 = Enable



UPC-E Minimum Read

This feature specifies the minimum number of consecutive UPC-E decodes before is accepted as good read.

To set this feature:

1. Scan the ENTER/EXIT Programming Mode bar code.
2. Scan your selection from the bar codes below. You'll need to cover any unused bar codes on this and the facing page to ensure that the scanner reads only the bar code you intend to scan.
3. Complete the programming sequence by scanning the ENTER/EXIT Programming Mode bar code.



★ UPC-E Minimum Read = 1



UPC-E Minimum Read = 2



UPC-E Minimum Read = 3



UPC-E Minimum Read = 4



EAN-13 ENABLE

Enables/disables the ability of the scanner to decode EAN/JAN-13 labels.

To set this feature:

1. Scan the Enter/Exit Programming Mode bar code.
2. Scan either the enable or disable bar code below. You'll need to cover any unused bar codes on this and the facing page to ensure that the scanner reads only the bar code you intend to scan.
3. Complete the programming sequence by scanning the Enter/Exit Programming Mode bar code.



EAN-13 = Disable



★ EAN-13 = Enable



EAN-13 First Character Transmission

Enables/disables transmission of EAN/JAN-13 first character.



NOTE: This item is ignored when the advanced feature, Full Label Edit, is enabled.

To set this feature:

1. Scan the Enter/Exit Programming Mode bar code.
2. Scan either the enable or disable bar code below. You'll need to cover any unused bar codes on this and the facing page to ensure that the scanner reads only the bar code you intend to scan.
3. Complete the programming sequence by scanning the Enter/Exit Programming Mode bar code.



EAN-13 First Character Transmission = Disable



★ EAN-13 First Character Transmission = Enable



EAN-13 Check Character Transmission

Enables/disables transmission of an EAN/JAN-13 check character.



NOTE: This item is ignored when the advanced feature, Full Label Edit, is enabled.

To set this feature:

1. Scan the Enter/Exit Programming Mode bar code.
2. Scan either the enable or disable bar code below. You'll need to cover any unused bar codes on this and the facing page to ensure that the scanner reads only the bar code you intend to scan.
3. Complete the programming sequence by scanning the Enter/Exit Programming Mode bar code.



EAN-13 Check Character Transmission = Disable



★ EAN-13 Check Character Transmission = Enable



EAN-13 ISBN Conversion Enable

Enables/disables conversion of EAN/JAN-13 labels starting with 978 to Bookland ISBN labels.

To set this feature:

1. Scan the Enter/Exit Programming Mode bar code.
2. Scan either the enable or disable bar code below. You'll need to cover any unused bar codes on this and the facing page to ensure that the scanner reads only the bar code you intend to scan.
3. Complete the programming sequence by scanning the Enter/Exit Programming Mode bar code.



★ EAN-13 ISBN Conversion = Disable



EAN-13 ISBN Conversion = Enable



EAN-13 Minimum Read

This feature specifies the minimum number of consecutive EAN-13 decodes before is accepted as good read.

To set this feature:

1. Scan the ENTER/EXIT Programming Mode bar code.
2. Scan your selection from the bar codes below. You'll need to cover any unused bar codes on this and the facing page to ensure that the scanner reads only the bar code you intend to scan.
3. Complete the programming sequence by scanning the ENTER/EXIT Programming Mode bar code.



★ EAN-13 Minimum Read = 1



EAN-13 Minimum Read = 2



EAN-13 Minimum Read = 3



EAN-13 Minimum Read = 4



EAN-8

- EAN-8 Check Character Transmission
- Expand EAN-8 to EAN-13
- EAN-8 Minimum Read
- EAN-8 Minimum Segment Length
- EAN-8 Guard Insertion
- EAN-8 Guard Substitution
- EAN-8/Jan-8 Both Guards Substitution
- EAN-8 Stitch Exact Label Halves
- EAN-8 Stitch Unlike Label Halves
- EAN-8 Decoding Levels

EAN-8 Enable

Enables/disables the ability of the scanner to decode EAN/JAN-8 labels.

To set this feature:

1. Scan the Enter/Exit Programming Mode bar code.
2. Scan either the enable or disable bar code below. You'll need to cover any unused bar codes on this and the facing page to ensure that the scanner reads only the bar code you intend to scan.
3. Complete the programming sequence by scanning the Enter/Exit Programming Mode bar code.



EAN-8 = Disable



★ EAN-8 = Enable



EAN-8 Check Character Transmission

Enables/disables transmission of an EAN/JAN-8 check character.



NOTE: This item is ignored when the advanced feature, Full Label Edit, is enabled.

To set this feature:

1. Scan the Enter/Exit Programming Mode bar code.
2. Scan either the enable or disable bar code below. You'll need to cover any unused bar codes on this and the facing page to ensure that the scanner reads only the bar code you intend to scan.
3. Complete the programming sequence by scanning the Enter/Exit Programming Mode bar code.



EAN-8 Check Character Transmission = Disable



★ EAN-8 Check Character Transmission = Enable



Expand EAN-8 to EAN-13

Enables/disables expansion of EAN/JAN-8 labels to EAN/JAN-13.

To set this feature:

1. Scan the Enter/Exit Programming Mode bar code.
2. Scan either the enable or disable bar code below. You'll need to cover any unused bar codes on this and the facing page to ensure that the scanner reads only the bar code you intend to scan.
3. Complete the programming sequence by scanning the Enter/Exit Programming Mode bar code.



★ Expand EAN-8 to EAN-13 = Disable



Expand EAN-8 to EAN-13 = Enable



EAN-8 Minimum Read

This feature specifies the minimum number of consecutive EAN-8 decodes before is accepted as good read.

To set this feature:

1. Scan the ENTER/EXIT Programming Mode bar code.
2. Scan your selection from the bar codes below. You'll need to cover any unused bar codes on this and the facing page to ensure that the scanner reads only the bar code you intend to scan.
3. Complete the programming sequence by scanning the ENTER/EXIT Programming Mode bar code.



★ EAN-8 Minimum Read = 1



EAN-8 Minimum Read = 2



EAN-8 Minimum Read = 3



EAN-8 Minimum Read = 4



EAN-8 Minimum Segment Length

Specifies the minimum number of characters necessary in an EAN-8/JAN-8 label segment in order for the scanner to accept a label for decoding. Selectable from 5 to 15 characters. Default setting for this feature is: 08 (8 characters).



EAN-8 Minimum Segment Length = 5 characters



EAN-8 Minimum Segment Length = 6 characters



EAN-8 Minimum Segment Length = 7 characters



★ EAN-8 Minimum Segment Length = 8 characters



EAN-8 Minimum Segment Length = 9 characters



EAN-8 Minimum Segment Length = 10 characters



EAN-8 Minimum Segment Length = 11 characters

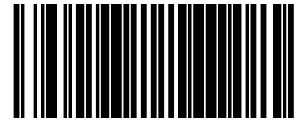

EAN-8 Minimum Segment Length = 12 characters



EAN-8 Minimum Segment Length = 13 characters



EAN-8 Minimum Segment Length = 14 characters



EAN-8 Minimum Segment Length = 15 characters



EAN-8 Guard Insertion

This setting enables the insertion of either a missing leading or trailing guard to a scanned bar code.

To set this feature:

1. Scan the Enter/Exit Programming Mode bar code.
2. Scan either the enable or disable bar code below. You'll need to cover any unused bar codes on this and the facing page to ensure that the scanner reads only the bar code you intend to scan.
3. Complete the programming sequence by scanning the Enter/Exit Programming Mode bar code.



★ EAN-8 Guard Insertion = Disable

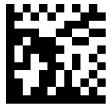

EAN-8 Guard Insertion = Enable



EAN-8 Guard Substitution

This setting enables the scanner to substitute a guard pattern for even-parity 6 for EAN8/JAN8 labels.

To set this feature:

1. Scan the Enter/Exit Programming Mode bar code.
2. Scan either the enable or disable bar code below. You'll need to cover any unused bar codes on this and the facing page to ensure that the scanner reads only the bar code you intend to scan.
3. Complete the programming sequence by scanning the Enter/Exit Programming Mode bar code.



★ EAN-8 Guard Insertion = Disable



EAN-8 Guard Insertion = Enable

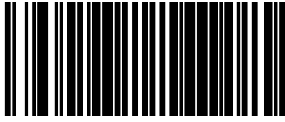

EAN-8/Jan-8 Both Guards Substitution

Enables/disables the ability of the scanner to find an EAN/JAN8 guard pattern in cases where the EAN/JAN8 margin makes the guard look like a character.

To set this feature:

1. Scan the Enter/Exit Programming Mode bar code.
2. Scan either the enable or disable bar code below. You'll need to cover any unused bar codes on this and the facing page to ensure that the scanner reads only the bar code you intend to scan.
3. Complete the programming sequence by scanning the Enter/Exit Programming Mode bar code.



★ EAN-8/JAN-8 Both Guards Substitution = Disable



EAN-8/JAN-8 Both Guards Substitution = Enable



EAN-8 Stitch Exact Label Halves

This setting enables the stitching of exact EAN-8 label halves with no overlapping characters.

To set this feature:

1. Scan the Enter/Exit Programming Mode bar code.
2. Scan either the enable or disable bar code below. You'll need to cover any unused bar codes on this and the facing page to ensure that the scanner reads only the bar code you intend to scan.
3. Complete the programming sequence by scanning the Enter/Exit Programming Mode bar code.



★ EAN-8 Stitch Exact Label Halves = Disable



EAN-8 Stitch Exact Label Halves = Enable



EAN-8 Stitch Unlike Label Halves

This setting enables the stitching of two EAN-8 label halves together that may have different characters.

To set this feature:

1. Scan the Enter/Exit Programming Mode bar code.
2. Scan either the enable or disable bar code below. You'll need to cover any unused bar codes on this and the facing page to ensure that the scanner reads only the bar code you intend to scan.
3. Complete the programming sequence by scanning the Enter/Exit Programming Mode bar code.



★ EAN-8 Stitch Unlike Label Halves = Disable



EAN-8 Stitch Unlike Label Halves = Enable



EAN-8 Decoding Levels

Decoding levels allow the decoder to be set to perform at one of four selectable levels:

- Very Conservative — Slower scan time, virtually eliminates misreads. The most secure setting.
- Slightly More Aggressive — Faster scanning, more aggressive, yet minimizes misreads.
- Moderately Aggressive — Even faster scanning, even more aggressive.
- Very Aggressive — Fastest scan speed, most aggressive.



CAUTION: Use caution when setting this feature, as more aggressive settings for this feature allow a higher potential for misreads.



★ EAN-8 Decoding Level = Very Conservative



EAN-8 Decoding Level = Slightly More Aggressive



EAN-8 Decoding Level = Moderately Aggressive



EAN-8 Decoding Level = Very Aggressive

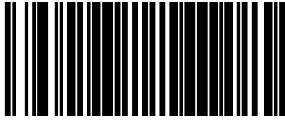

OTHER UPC/EAN OPTIONS

The following pages contain other selectable features for UPC/EAN symbologies:

- In-Store Printed Label Minimum Read
- UPC/EAN Reconstruction
- UPC/EAN Correlation
- UPC/EAN Guard Insertion
- UPC/EAN Stitch Exact Label Halves
- UPC/EAN Stitch Unlike Label Halves
- UPC/EAN Minimum Segment Length
- Price Weight Check
- Enable EAN Two Label
- Addons



In-Store Printed Label Minimum Read

This feature specifies the minimum number of consecutive In-Store Printed Label decodes before is accepted as good read.

To set this feature:

1. Scan the ENTER/EXIT Programming Mode bar code.
2. Scan your selection from the bar codes below. You'll need to cover any unused bar codes on this and the facing page to ensure that the scanner reads only the bar code you intend to scan.
3. Complete the programming sequence by scanning the ENTER/EXIT Programming Mode bar code.



★ In-Store Printed Label Minimum Read = 1



In-Store Printed Label Minimum Read = 2



In-Store Printed Label Minimum Read = 3



In-Store Printed Label Minimum Read = 4



UPC/EAN Reconstruction

Enables/disables the ability of the scanner to decode a class of UPC/EAN labels with voids. The label voids may be caused by printing defects or physical damage. This feature may be helpful in environments with in-store printed labels.



CAUTION: Enabling this feature increases the potential of misreads.

To set this feature:

1. Scan the Enter/Exit Programming Mode bar code.
2. Scan either the enable or disable bar code below. You'll need to cover any unused bar codes on this and the facing page to ensure that the scanner reads only the bar code you intend to scan.
3. Complete the programming sequence by scanning the Enter/Exit Programming Mode bar code.



★ UPC/EAN Reconstruction = Disable



UPC/EAN Reconstruction = Enable



UPC/EAN Correlation

Enables/disables character correlation for UPC/EAN.

To set this feature:

1. Scan the ENTER/EXIT Programming Mode bar code.
2. Scan either the enable or disable barcode below. You'll need to cover any unused barcodes on this and the facing page to ensure that the scanner reads only the barcode you intend to scan.
3. Complete the programming sequence by scanning the ENTER/EXIT Programming Mode bar code.

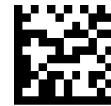

★ UPC/EAN Correlation = Disable



UPC/EAN Correlation = Enable



UPC/EAN Guard Insertion

This setting enables the insertion of either a missing leading or trailing guard to a scanned bar code.

To set this feature:

1. Scan the Enter/Exit Programming Mode bar code.
2. Scan either the enable or disable bar code below. You'll need to cover any unused bar codes on this and the facing page to ensure that the scanner reads only the bar code you intend to scan.
3. Complete the programming sequence by scanning the Enter/Exit Programming Mode bar code.



★ UPC/EAN Guard Insertion = Disable



UPC/EAN Guard Insertion = Enable



UPC/EAN Stitch Exact Label Halves

This setting enables the stitching of exact UPC-A/EAN-13 label halves with no overlapping characters.

To set this feature:

1. Scan the Enter/Exit Programming Mode bar code.
2. Scan either the enable or disable bar code below. You'll need to cover any unused bar codes on this and the facing page to ensure that the scanner reads only the bar code you intend to scan.
3. Complete the programming sequence by scanning the Enter/Exit Programming Mode bar code.



★ UPC/EAN Stitch Exact Label Halves = Disable

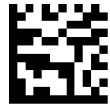

UPC/EAN Stitch Exact Label Halves = Enable



UPC/EAN Stitch Unlike Label Halves

This setting enables the stitching of two UPC-A/EAN-13 label halves together that may have different characters.

To set this feature:

1. Scan the Enter/Exit Programming Mode bar code.
2. Scan either the enable or disable bar code below. You'll need to cover any unused bar codes on this and the facing page to ensure that the scanner reads only the bar code you intend to scan.
3. Complete the programming sequence by scanning the Enter/Exit Programming Mode bar code.



★ UPC/EAN Stitch Unlike Label Halves = Disable



UPC/EAN Stitch Unlike Label Halves = Enable



UPC/EAN Minimum Segment Length

This feature specifies the minimum number of characters needed in a UPC/EAN segment in order to be accepted for decoding.

To set this feature:

1. Scan the Enter/Exit Programming Mode bar code.
2. Scan the bar code for the desired setting below. You'll need to cover any unused bar codes on this and the facing page to ensure that the scanner reads only the bar code you intend to scan.
3. Complete the programming sequence by scanning the Enter/Exit Programming Mode bar code.



★ UPC/EAN Minimum Segment Length = 5 Characters



UPC/EAN Minimum Segment Length = 6 Characters



UPC/EAN Minimum Segment Length = 7 Characters



UPC/EAN Minimum Segment Length = 8 Characters



UPC/EAN Minimum Segment Length = 9 Characters



UPC/EAN Minimum Segment Length (continued)



UPC/EAN Minimum Segment Length = 10 Characters



UPC/EAN Minimum Segment Length = 11 Characters



UPC/EAN Minimum Segment Length = 12 Characters



UPC/EAN Minimum Segment Length = 13 Characters



UPC/EAN Minimum Segment Length = 14 Characters



UPC/EAN Minimum Segment Length = 15 Characters

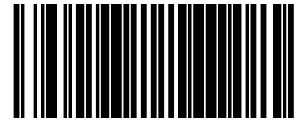

Price Weight Check

Enables/disables calculation and verification of price/weight check digits. Applies to all UPC-A and EAN/JAN-13 labels with eligible¹ Number System/First Character digits.

Options are:

- Disable
- 4-digit price/weight
- 5-digit price/weight
- 4-digit European price/weight
- 5-digit European price/weight

To set this feature:

1. Scan the Enter/Exit Programming Mode bar code.
2. Scan the barcode representing the desired option below or on the following pages. You'll need to cover any unused barcodes on facing pages to ensure that the scanner reads only the barcode you intend to scan.
3. Complete the programming sequence by scanning the Enter/Exit Programming Mode bar code.



★ Price Weight Check = Disable



Price Weight Check = 4-digit price/weight



Price Weight Check = 5-digit price/weight

1. Price Weight Check generally applies to UPC-A labels with a Number System Digit of 2 and EAN/JAN-13 labels with a First Character of 2. There are a total of six flag digits corresponding to the six types. Checking applies depending upon which type is enabled.

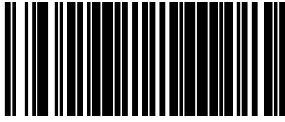

Price Weight Check (continued)



Price Weight Check = 4-digit European price/weight



Price Weight Check = 5-digit European price/weight



Enable EAN Two Label

Enables/disables the ability of the scanner to decode EAN two-label pairs.

To set this feature:

1. Scan the Enter/Exit Programming Mode bar code.
2. Scan either the enable or disable barcode below. You'll need to cover any unused barcodes on this and the facing page to ensure that the scanner reads only the barcode you intend to scan.
3. Complete the programming sequence by scanning the Enter/Exit Programming Mode bar code.



NOTE: Contact Customer Support for details about advanced programming for this feature.



★ EAN Two Label = Disable



EAN Two Label = Enable



EAN Two Label Minimum Read

This feature specifies the minimum number of consecutive EAN Two Label decodes before is accepted as good read.

To set this feature:

1. Scan the ENTER/EXIT Programming Mode bar code.
2. Scan your selection from the bar codes below. You'll need to cover any unused bar codes on this and the facing page to ensure that the scanner reads only the bar code you intend to scan.
3. Complete the programming sequence by scanning the ENTER/EXIT Programming Mode bar code.



★ EAN Two Label Minimum Read = 1



EAN Two Label Minimum Read = 2



EAN Two Label Minimum Read = 3



EAN Two Label Minimum Read = 4



EAN Two Label Combined Transmission

Enables/disables the transmitting of an EAN two label pair as one label.

To set this feature:

1. Scan the Enter/Exit Programming Mode bar code.
2. Scan either the enable or disable bar code below. You'll need to cover any unused bar codes on this and the facing page to ensure that the scanner reads only the bar code you intend to scan.
3. Complete the programming sequence by scanning the Enter/Exit Programming Mode bar code.



★ EAN Two Label Combined Transmission = Disable



EAN Two Label Combined Transmission = Enable

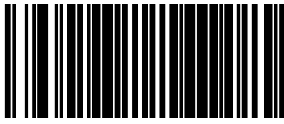

Addons

The scanner is capable of processing different types of addon codes, including:

- 2-Digit Supplemental
- 5-Digit Supplemental

Options are provided on the following pages for your convenience:

- Disable all addons — The scanner will not look for or read addons.
- Optional 2-Digit and 5-Digit Supplemental — Barcodes can be read which include 2-Digit or 5-Digit Supplementals, however, it is not required that addons be included in barcodes.



NOTE: Contact customer support for advanced programming of optional and conditional addons.

To set this feature:

1. Scan the Enter/Exit Programming Mode bar code.
2. Scan the barcode representing the desired option on this and the following page. You'll need to cover any unused barcodes on facing pages to ensure that the scanner reads only the barcode you intend to scan.
3. Complete the programming sequence by scanning the Enter/Exit Programming Mode bar code.



★ Addons = Disable All Addons



Addons = Optional 2-Digit and 5-Digit Supplemental



P2 Addon Minimum Read

This feature specifies the minimum number of times a P2 addon must decode before it is marked valid.

To set this feature:

1. Scan the Enter/Exit Programming Mode bar code.
2. Scan the barcode representing the desired option on this and the following page. You'll need to cover any unused barcodes on facing pages to ensure that the scanner reads only the barcode you intend to scan.
3. Complete the programming sequence by scanning the Enter/Exit Programming Mode bar code.



★ P2 Addon Minimum Read = 2



P2 Addon Minimum Read = 3



P2 Addon Minimum Read = 4



P2 Addon Minimum Read = 5



P2 Addon Minimum Read = 6



P2 Addon Minimum Read (continued)



P2 Addon Minimum Read = 7



P2 Addon Minimum Read = 8



P2 Addon Minimum Read = 9



P2 Addon Minimum Read = 10



P2 Addon Minimum Read = 11



P2 Addon Minimum Read = 12



P2 Addon Minimum Read = 13



P2 Addon Minimum Read (continued)



P2 Addon Minimum Read = 14



P2 Addon Minimum Read = 15



P5 Addon Minimum Read

This feature specifies the minimum number of times a P5 addon must decode before it is marked valid.

To set this feature:

1. Scan the Enter/Exit Programming Mode bar code.
2. Scan the barcode representing the desired option on this and the following page. You'll need to cover any unused barcodes on facing pages to ensure that the scanner reads only the barcode you intend to scan.
3. Complete the programming sequence by scanning the Enter/Exit Programming Mode bar code.



★ P5 Addon Minimum Read = 1



P5 Addon Minimum Read = 2



P5 Addon Minimum Read = 3



P5 Addon Minimum Read = 4



P5 Addon Minimum Read = 5



P5 Addon Minimum Read = 6

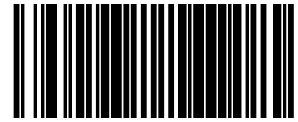

P5 Addon Minimum Read (continued)



P5 Addon Minimum Read = 7



P5 Addon Minimum Read = 8



P5 Addon Minimum Read = 9



P5 Addon Minimum Read = 10



P5 Addon Minimum Read = 11



P5 Addon Minimum Read = 12



P5 Addon Minimum Read = 13

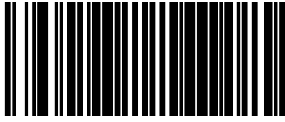

P5 Addon Minimum Read (continued)



P5 Addon Minimum Read = 14



P5 Addon Minimum Read = 15



GTIN ENABLE

Enables/Disables the ability to convert UPCE, UPCA, EAN8, and EAN13 labels into the GTIN 14-character format.



NOTE: If add-on information is present on the base label prior to the conversion taking place, the add-on information will be appended to the converted GTIN barcode.

To set this feature:

1. Scan the Enter/Exit Programming Mode bar code.
2. Scan either the enable or disable barcode below. You'll need to cover any unused bar codes on this and the facing page to ensure that the scanner reads only the bar code you intend to scan.
3. Complete the programming sequence by scanning the Enter/Exit Programming Mode bar code.



★ GTIN = Disable



GTIN = Enable

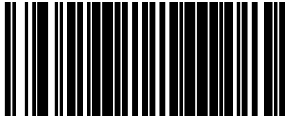

GS1 DATABAR

The symbology family, GS1 DataBar™, was formerly known as Reduced Space Symbology (RSS). For the purpose of simplicity, GS1 DataBar variants are listed in this manual as “DataBar.”

DATABAR OMNIDIRECTIONAL ENABLE

Enables/disables the ability of the scanner to decode DataBar Omnidirectional labels.



NOTE: This value-added feature is a factory-programmed option. Contact your dealer for information about upgrading your system to include this advanced capability.

To set this feature:

1. Scan the ENTER/EXIT Programming Mode bar code.
2. Scan either the enable or disable barcode below. You'll need to cover any unused bar codes on this and the facing page to ensure that the scanner reads only the bar code you intend to scan.
3. Complete the programming sequence by scanning the ENTER/EXIT Programming Mode bar code.



★ DataBar Omnidirectional = Disable



DataBar Omnidirectional = Enable



DataBar Omnidirectional/EAN-128 Emulation

Enables/disables the ability of DataBar Omnidirectional to be transmitted as EAN-128.

1. To set this feature:
2. Scan the ENTER/EXIT Programming Mode bar code.
3. Scan either the enable or disable barcode below. You'll need to cover any unused barcodes on this and the facing page to ensure that the scanner reads only the barcode you intend to scan.
4. Complete the programming sequence by scanning the ENTER/EXIT Programming Mode bar code.



★ DataBar Omnidirectional/EAN-128 Emulation = Disable



DataBar Omnidirectional/EAN-128 Emulation = Enable

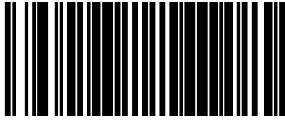

DataBar Omnidirectional 2D Component Enable

When this feature is enabled, the software will not decode an DataBar Omnidirectional barcode with a 2D component associated with it, and the 2D component will be discarded.

To set this feature:

1. Scan the ENTER/EXIT Programming Mode bar code.
2. Scan your selection from the barcodes below. You'll need to cover any unused barcodes on this and the facing page to ensure that the scanner reads only the barcode you intend to scan.
3. Complete the programming sequence by scanning the ENTER/EXIT Programming Mode bar code.



★ DataBar Omnidirectional 2D Component = Disable



DataBar Omnidirectional 2D Component = Enable



DataBar Omnidirectional Minimum Read

This feature specifies the minimum number of consecutive DataBar Omnidirectional decodes before is accepted as good read.

To set this feature:

1. Scan the ENTER/EXIT Programming Mode bar code.
2. Scan your selection from the bar codes below. You'll need to cover any unused bar codes on this and the facing page to ensure that the scanner reads only the bar code you intend to scan.
3. Complete the programming sequence by scanning the ENTER/EXIT Programming Mode bar code.



★ DataBar Omnidirectional Minimum Read = 1



DataBar Omnidirectional Minimum Read = 2



DataBar Omnidirectional Minimum Read = 3



DataBar Omnidirectional Minimum Read = 4



DataBar Omnidirectional Double Read Timeout

Specifies the minimum allowable time which must pass before reading the same DataBar Omnidirectional label again (e.g. two identical items in succession).

To set this feature:

1. Scan the Enter/Exit Programming Mode bar code.
2. Scan your selection from the bar codes below. You'll need to cover any unused bar codes on this and the facing page to ensure that the scanner reads only the bar code you intend to scan.

Complete the programming sequence by scanning the Enter/Exit Programming Mode bar code.



DataBar Omnidirectional Double Read
Timeout = 0.5 Seconds



DataBar Omnidirectional Double Read
Timeout = 1 Second



★ DataBar Omnidirectional Double Read
Timeout = 2.5 Seconds



DataBar Omnidirectional Double Read
Timeout = 3 Seconds



DataBar Omnidirectional Double Read
Timeout = 3.5 Seconds



DATABAR EXPANDED ENABLE

Enables/disables the ability of the scanner to decode DataBar Expanded labels.



NOTE: This value-added feature is a factory-programmed option. Contact your dealer for information about upgrading your system to include this advanced capability.

To set this feature:

1. Scan the ENTER/EXIT Programming Mode bar code.
2. Scan either the enable or disable barcode below. You'll need to cover any unused barcodes on this and the facing page to ensure that the scanner reads only the barcode you intend to scan.
3. Complete the programming sequence by scanning the ENTER/EXIT Programming Mode bar code.



★ DataBar Expanded = Disable



DataBar Expanded = Enable



DataBar Expanded EAN-128 Emulation

Enables/disables EAN 128 emulation for DataBar Expanded.

To set this feature:

1. Scan the ENTER/EXIT Programming Mode bar code.
2. Scan either the enable or disable barcode below. You'll need to cover any unused barcodes on this and the facing page to ensure that the scanner reads only the barcode you intend to scan.
3. Complete the programming sequence by scanning the ENTER/EXIT Programming Mode bar code.



★ DataBar Expanded EAN-128 Emulation = Disable



DataBar Expanded EAN-128 Emulation = Enable



DataBar Expanded 2D Component Enable

When this feature is enabled, the software will not decode an DataBar Expanded bar code with a 2D component associated with it, and the 2D component will be discarded.

To set this feature:

1. Scan the ENTER/EXIT Programming Mode bar code.
2. Scan your selection from the barcodes below. You'll need to cover any unused barcodes on this and the facing page to ensure that the scanner reads only the barcode you intend to scan.
3. Complete the programming sequence by scanning the ENTER/EXIT Programming Mode bar code.



★ DataBar Expanded 2D Component = Disable



DataBar Expanded 2D Component = Enable



DataBar Expanded Minimum Read

This feature specifies the minimum number of consecutive DataBar Expanded decodes before is accepted as good read.

To set this feature:

1. Scan the ENTER/EXIT Programming Mode bar code.
2. Scan your selection from the bar codes below. You'll need to cover any unused bar codes on this and the facing page to ensure that the scanner reads only the bar code you intend to scan.
3. Complete the programming sequence by scanning the ENTER/EXIT Programming Mode bar code.



★ DataBar Expanded Minimum Read = 1



DataBar Expanded Minimum Read = 2



DataBar Expanded Minimum Read = 3



DataBar Expanded Minimum Read = 4



DataBar Expanded Length Control

This feature specifies either variable-length or fixed-length decoding for DataBar Expanded.

To set this feature:

1. Scan the ENTER/EXIT Programming Mode bar code.
2. Scan your selection from the barcodes below. You'll need to cover any unused barcodes on this and the facing page to ensure that the scanner reads only the barcode you intend to scan.
3. Complete the programming sequence by scanning the ENTER/EXIT Programming Mode bar code.



★ DataBar Expanded Length Control = Variable Length



DataBar Expanded Length Control = Fixed Length

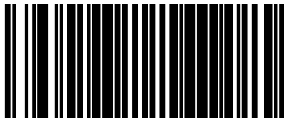

DataBar Expanded Length 1

Length 1 is the minimum label length if in variable length mode, or the first fixed length if in fixed length mode. Length includes the bar code's data characters only.

To set this feature:

1. Scan the ENTER/EXIT Programming Mode bar code.
2. Scan the barcode, [Set DataBar Expanded Length 1](#) below. You'll need to cover any unused barcodes on this and the facing page to ensure that the scanner reads only the barcode you intend to scan.
3. Scan the appropriate digits from the [Keypad](#) in [Appendix C](#) that represent the desired label length. The selectable range for this option is 00 to 74. Pad all single digit numbers with a leading zero to yield a two-digit entry (00-74).
4. Complete the programming sequence by scanning the ENTER/EXIT Programming Mode bar code.



Set DataBar Expanded Length 1

★ Default setting for this feature = 01



DataBar Expanded Length 2

Length 2 is the maximum label length if in variable length mode, or the second fixed length if in fixed length mode. Length includes the barcode's data characters only.



NOTE: When in Fixed Length mode, if Length 2 is set to the value of 00 (zero), then only Length 1 will apply.

To set this feature:

1. Scan the ENTER/EXIT Programming Mode bar code.
2. Scan the barcode, [Set DataBar Expanded Length 2](#) below. You'll need to cover any unused barcodes on this and the facing page to ensure that the scanner reads only the barcode you intend to scan.
3. Scan the appropriate digits from the [Keypad](#) in [Appendix C](#) that represent the desired label length. The selectable range for this option is 00 to 74. Pad all single digit numbers with a leading zero to yield a two-digit entry (00-74).
4. Complete the programming sequence by scanning the ENTER/EXIT Programming Mode bar code.



Set DataBar Expanded Length 2

★ Default setting for this feature = 74



DataBar Expanded Reverse Retry Enable

Enables/disables the reading of out of specification labels where the last row has been printed in reverse.

- When enabled, DataBar Expanded Stacked labels that have the last row incorrectly printed in reverse will be re-decoded.
- When disabled, DataBar Expanded Stacked labels that have the last row incorrectly printed in reverse will not be read.

To set this feature:

1. Scan the ENTER/EXIT Programming Mode bar code.
2. Scan your selection from the bar codes below. You'll need to cover any unused bar codes on this and the facing page to ensure that the scanner reads only the bar code you intend to scan.
3. Complete the programming sequence by scanning the ENTER/EXIT Programming Mode bar code.



★ DataBar Expanded Reverse Retry = Disable



DataBar Expanded Reverse Retry = Enable



DATABAR LIMITED

DataBar Limited Enable

Enables/disables the ability of the scanner to decode DataBar Limited labels.

To set this feature:

1. Scan the ENTER/EXIT Programming Mode bar code.
2. Scan either the enable or disable bar code below. You'll need to cover any unused bar codes on this and the facing page to ensure that the scanner reads only the bar code you intend to scan.
3. Complete the programming sequence by scanning the ENTER/EXIT Programming Mode bar code.



★ Databar Limited = Disable



Databar Limited = Enable



DataBar Limited Minimum Read

This feature specifies the minimum number of consecutive Databar Limited decodes before is accepted as good read.

To set this feature:

1. Scan the ENTER/EXIT Programming Mode bar code.
2. Scan either the enable or disable bar code below. You'll need to cover any unused bar codes on this and the facing page to ensure that the scanner reads only the bar code you intend to scan.
3. Complete the programming sequence by scanning the ENTER/EXIT Programming Mode bar code.



★ Databar Limited Minimum Read = 1



Databar Limited Minimum Read = 2



Databar Limited Minimum Read = 3



Databar Limited Minimum Read = 4



DataBar Limited 2D Component Enable

This feature controls if a 2D label component be decoded when a Databar Limited base label is decoded.

To set this feature:

1. Scan the ENTER/EXIT Programming Mode bar code.
2. Scan either the enable or disable bar code below. You'll need to cover any unused bar codes on this and the facing page to ensure that the scanner reads only the bar code you intend to scan.
3. Complete the programming sequence by scanning the ENTER/EXIT Programming Mode bar code.



★ Databar Limited 2D Component = Disable



Databar Limited 2D Component = Enable



DataBar Limited EAN128 Emulation Enable

Enables/disables GS1-EAN128 emulation for GS1 Databar Limited.

To set this feature:

1. Scan the ENTER/EXIT Programming Mode bar code.
2. Scan either the enable or disable bar code below. You'll need to cover any unused bar codes on this and the facing page to ensure that the scanner reads only the bar code you intend to scan.
3. Complete the programming sequence by scanning the ENTER/EXIT Programming Mode bar code.



★ Databar Limited EAN128 Emulation = disable



Databar Limited EAN128 Emulation = enable



CODE 39 ENABLE

Enables/disables the ability of the scanner to decode Code 39 labels.

To set this feature:

1. Scan the ENTER/EXIT Programming Mode bar code.
2. Scan either the enable or disable barcode below. You'll need to cover any unused barcodes on this and the facing page to ensure that the scanner reads only the barcode you intend to scan.
3. Complete the programming sequence by scanning the ENTER/EXIT Programming Mode bar code.



Code 39 = Disable



★ Code 39 = Enable



Code 39 Start Stop Character Transmission

Enables/disables transmission of Code 39 start and stop characters.



NOTE: This item is ignored when the advanced feature, Full Label Edit, is enabled

To set this feature:

1. Scan the ENTER/EXIT Programming Mode bar code.
2. Scan either the enable or disable barcode below. You'll need to cover any unused barcodes on this and the facing page to ensure that the scanner reads only the barcode you intend to scan.
3. Complete the programming sequence by scanning the ENTER/EXIT Programming Mode bar code.



★ Code 39 Start Stop Character Transmission = Disable



Code 39 Start Stop Character Transmission = Enable



Code 39 Check Character Calculation

Enables/disables calculation and verification of an optional Code 39 check character. When disabled, any check character in label is treated as a data character.



NOTE: If check calculation is disabled, the risk is increased that a mis-read can occur.

To set this feature:

1. Scan the ENTER/EXIT Programming Mode bar code.
2. Scan either the enable or disable barcode below. You'll need to cover any unused barcodes on this and the facing page to ensure that the scanner reads only the barcode you intend to scan.
3. Complete the programming sequence by scanning the ENTER/EXIT Programming Mode bar code.



★ Code 39 Check Character Calculation = Disable



Code 39 Check Character Calculation = Enable



Code 39 Check Character Transmission

Enables/disables transmission of optional Code 39 check character.



NOTE: This item is ignored when the advanced feature, Full Label Edit, is enabled

To set this feature:

1. Scan the ENTER/EXIT Programming Mode bar code.
2. Scan either the enable or disable barcode below. You'll need to cover any unused barcodes on this and the facing page to ensure that the scanner reads only the barcode you intend to scan.
3. Complete the programming sequence by scanning the ENTER/EXIT Programming Mode bar code.



Code 39 Check Character Transmission = Disable



★ Code 39 Check Character Transmission = Enable



Code 39 Full ASCII

Enables/disables the ability of the scanner to translate to Code 39 full ASCII labels.

To set this feature:

1. Scan the ENTER/EXIT Programming Mode bar code.
2. Scan either the enable or disable barcode below. You'll need to cover any unused barcodes on this and the facing page to ensure that the scanner reads only the barcode you intend to scan.
3. Complete the programming sequence by scanning the ENTER/EXIT Programming Mode bar code.



★ Code 39 Full ASCII = Disable



Code 39 Full ASCII = Enable



Code 39 Minimum Read

This feature specifies the minimum number of consecutive Code 39 decodes before is accepted as good read.

To set this feature:

1. Scan the ENTER/EXIT Programming Mode bar code.
2. Scan your selection from the bar codes below. You'll need to cover any unused bar codes on this and the facing page to ensure that the scanner reads only the bar code you intend to scan.
3. Complete the programming sequence by scanning the ENTER/EXIT Programming Mode bar code.



★ Code 39 Minimum Read = 1



Code 39 Minimum Read = 2



Code 39 Minimum Read = 3



Code 39 Minimum Read = 4



Code 39 Correlation

Enables/disables character correlation for Code 39.

To set this feature:

1. Scan the ENTER/EXIT Programming Mode bar code.
2. Scan either the enable or disable barcode below. You'll need to cover any unused barcodes on this and the facing page to ensure that the scanner reads only the barcode you intend to scan.
3. Complete the programming sequence by scanning the ENTER/EXIT Programming Mode bar code.



★ Code 39 Correlation = Disable



Code 39 Correlation = Enable



Code 39 Length Control

This feature specifies whether variable-length or fixed-length decoding will be set for Code 39.

To set this feature:

1. Scan the ENTER/EXIT Programming Mode bar code.
2. Scan your selection from the barcodes below. You'll need to cover any unused barcodes on this and the facing page to ensure that the scanner reads only the barcode you intend to scan.
3. Complete the programming sequence by scanning the ENTER/EXIT Programming Mode bar code.



★ Code 39 Length Control = Variable Length



Code 39 Length Control = Fixed Length

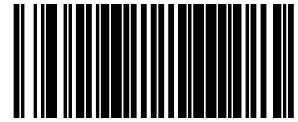

Code 39 Length 1

If Code 39 Length Control is set to Fixed-Length decoding, this feature specifies Code 39 first fixed length. If Code 39 Length Control is set to Variable-Length decoding, this feature specifies the minimum label length.

To set this feature:

1. Scan the ENTER/EXIT Programming Mode bar code.
2. Scan the barcode, [Set Code 39 Length 1](#) below. You'll need to cover any unused barcodes on this and the facing page to ensure that the scanner reads only the barcode you intend to scan.
3. Scan the appropriate digits from the [Keypad](#) in [Appendix C](#) that represent the desired label length. The selectable range for this option is 00 to 50. Pad all single digit numbers with a leading zero to yield a two-digit entry (00-50).
4. Complete the programming sequence by scanning the ENTER/EXIT Programming Mode bar code.



Set Code 39 Length 1

★ Default setting for this feature = 02

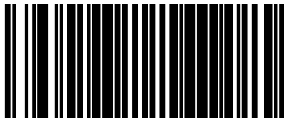

Code 39 Length 2

If Code 39 Length Control is set to Fixed-Length decoding, this feature specifies Code 39 second fixed length. If Code 39 Length Control is set to Variable-Length decoding, this feature specifies the maximum label length.



NOTE: When in Fixed Length mode, if Length 2 is set to the value of 00, then only Length 1 will apply

To set this feature:

1. Scan the ENTER/EXIT Programming Mode bar code.
2. Scan the barcode, [Set Code 39 Length 2](#) below. You'll need to cover any unused barcodes on this and the facing page to ensure that the scanner reads only the barcode you intend to scan.
3. Scan the appropriate digits from the [Keypad](#) in [Appendix C](#) that represent the desired label length. The selectable range for this option is 00, no second fixed length, or 01 to 50. Pad all single digit numbers with a leading zero to yield a two-digit entry (00-50).
4. Complete the programming sequence by scanning the ENTER/EXIT Programming Mode bar code.



Set Code 39 Length 2

★ Default setting for this feature = 50



Code 39 Stitching

Enables/disables stitching for Code 39 labels. When parts of a Code 39 barcode are presented to the scanner with this feature enabled, the barcode parts will be assembled by the scanner's software, and the data will be decoded if all barcode proofing requirements are met.

To set this feature:

1. Scan the ENTER/EXIT Programming Mode bar code.
2. Scan your selection from the barcodes below. You'll need to cover any unused barcodes on this and the facing page to ensure that the scanner reads only the barcode you intend to scan.
3. Complete the programming sequence by scanning the ENTER/EXIT Programming Mode bar code.



Code 39 Stitching = Disable



★ Code 39 Stitching = Enable

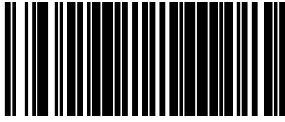

Code 39 Require Margins

Enables/disables the requirement that quiet zones be present in a Code 39 bar code.

To set this feature:

1. Scan the ENTER/EXIT Programming Mode bar code.
2. Scan either the enable or disable bar code below. You'll need to cover any unused bar codes on this and the facing page to ensure that the scanner reads only the bar code you intend to scan.
3. Complete the programming sequence by scanning the ENTER/EXIT Programming Mode bar code.



★ Code 39 Require Margins = Quiet Zones Not Required



Code 39 Require Margins = Quiet Zones Required



CODE 32 ITALIAN PHARMACODE ENABLE

Enables/disables the ability of the scanner to decode Italian Pharmaceutical Code 39 labels.

To set this feature:

1. Scan the ENTER/EXIT Programming Mode bar code.
2. Scan either the enable or disable barcode below. You'll need to cover any unused barcodes on this and the facing page to ensure that the scanner reads only the barcode you intend to scan.
3. Complete the programming sequence by scanning the ENTER/EXIT Programming Mode bar code.



★ Code 32 Italian Pharmacode Enable = Disable



Code 32 Italian Pharmacode Enable = Enable



Code 32 Start Stop Character Transmission

Enables/ disables transmission of start and stop characters for Code 32.



NOTE: This item is ignored when the advanced feature, Full Label Edit, is enabled

To set this feature:

1. Scan the ENTER/EXIT Programming Mode bar code.
2. Scan either the enable or disable barcode below. You'll need to cover any unused barcodes on this and the facing page to ensure that the scanner reads only the barcode you intend to scan.
3. Complete the programming sequence by scanning the ENTER/EXIT Programming Mode bar code.



★ Code 32 Start Stop Character Transmission = Disable



Code 32 Start Stop Character Transmission = Enable



Code 32 Check Character Transmission

Enables/disables transmission of Code 32 check character.



NOTE: This item is ignored when the advanced feature, Full Label Edit, is enabled

To set this feature:

1. Scan the ENTER/EXIT Programming Mode bar code.
2. Scan either the enable or disable barcode below. You'll need to cover any unused barcodes on this and the facing page to ensure that the scanner reads only the barcode you intend to scan.
3. Complete the programming sequence by scanning the ENTER/EXIT Programming Mode bar code.



★ Code 32 Check Character Transmission = Disable



Code 32 Check Character Transmission = Enable



CODE 128 ENABLE

Enables/disables the ability of the scanner to decode Code 128 labels.

To set this feature:

1. Scan the ENTER/EXIT Programming Mode bar code.
2. Scan either the enable or disable barcode below. You'll need to cover any unused barcodes on this and the facing page to ensure that the scanner reads only the barcode you intend to scan.
3. Complete the programming sequence by scanning the ENTER/EXIT Programming Mode bar code.



Code 128 = Disable



★ Code 128 = Enable



Code 128 Transmit Function Characters

Enables/disables transmission of Code 128 function characters 1, 2, 3, and 4.



NOTE: Disabled is the recommended setting for all interfaces.

To set this feature:

1. Scan the ENTER/EXIT Programming Mode bar code.
2. Scan either the enable or disable barcode below. You'll need to cover any unused barcodes on this and the facing page to ensure that the scanner reads only the barcode you intend to scan.
3. Complete the programming sequence by scanning the ENTER/EXIT Programming Mode bar code.



★ Code 128 Transmit Function Characters = Disable



Code 128 Transmit Function Characters = Enable



Expand Code 128 to Code 39

Enables/disables expansion of Code 128 labels to Code 39.

To set this feature:

1. Scan the ENTER/EXIT Programming Mode bar code.
2. Scan either the enable or disable barcode below. You'll need to cover any unused barcodes on this and the facing page to ensure that the scanner reads only the barcode you intend to scan.
3. Complete the programming sequence by scanning the ENTER/EXIT Programming Mode bar code.



★ Expand Code 128 to Code 39 = Disable



Expand Code 128 to Code 39 = Enable



Code 128 Minimum Read

This feature specifies the minimum number of consecutive Code 128 decodes before is accepted as good read.

To set this feature:

1. Scan the ENTER/EXIT Programming Mode bar code.
2. Scan your selection from the bar codes below. You'll need to cover any unused bar codes on this and the facing page to ensure that the scanner reads only the bar code you intend to scan.
3. Complete the programming sequence by scanning the ENTER/EXIT Programming Mode bar code.



★ Code 128 Minimum Read = 1



Code 128 Minimum Read = 2



Code 128 Minimum Read = 3



Code 128 Minimum Read = 4



Code 128 Correlation

Enables/disables character correlation for Code 128.

To set this feature:

1. Scan the ENTER/EXIT Programming Mode bar code.
2. Scan either the enable or disable barcode below. You'll need to cover any unused barcodes on this and the facing page to ensure that the scanner reads only the barcode you intend to scan.
3. Complete the programming sequence by scanning the ENTER/EXIT Programming Mode bar code.



★ Code 128 Correlation = Disable



Code 128 Correlation = Enable



Code 128 Length Control

This feature specifies whether variable-length or fixed-length decoding will be set for Code 128.

To set this feature:

1. Scan the ENTER/EXIT Programming Mode bar code.
2. Scan your selection from the barcodes below. You'll need to cover any unused barcodes on this and the facing page to ensure that the scanner reads only the barcode you intend to scan.
3. Complete the programming sequence by scanning the ENTER/EXIT Programming Mode bar code.



★ Code 128 Length Control = Variable Length



Code 128 Length Control = Fixed Length



Code 128 Length 1

If Code 128 Length Control is set to Fixed-Length decoding, this feature specifies Code 128 first fixed length. If Code 128 Length Control is set to Variable-Length decoding, this feature specifies the minimum label length.

To set this feature:

1. Scan the ENTER/EXIT Programming Mode bar code.
2. Scan the barcode, [Set Code 128 Length 1](#) below. You'll need to cover any unused barcodes on this and the facing page to ensure that the scanner reads only the barcode you intend to scan.
3. Scan the appropriate digits from the [Keypad](#) in [Appendix C](#) that represent the desired label length. The selectable range for this option is 01 to 80. Pad all single digit numbers with a leading zero to yield a two-digit entry (01-80).
4. Complete the programming sequence by scanning the ENTER/EXIT Programming Mode bar code.



Set Code 128 Length 1

★ Default setting for this feature = 01



Code 128 Length 2

If Code 128 Length Control is set to Fixed-Length decoding, this feature specifies Code 128 second fixed length. If Code 128 Length Control is set to Variable-Length decoding, this feature specifies the maximum label length.



NOTE: When in Fixed Length mode, if Length 2 is set to the value of 00 (zero), then only Length 1 will apply.

To set this feature:

1. Scan the ENTER/EXIT Programming Mode bar code.
2. Scan the barcode, [Set Code 128 Length 2](#) below. You'll need to cover any unused barcodes on this and the facing page to ensure that the scanner reads only the barcode you intend to scan.
3. Scan the appropriate digits from the [Keypad](#) in [Appendix C](#) that represent the desired label length. The selectable range for this option is 01 to 80. Pad all single digit numbers with a leading zero to yield a two-digit entry (01-80).
4. Complete the programming sequence by scanning the ENTER/EXIT Programming Mode bar code.



Set Code 128 Length 2

★ Default setting for this feature = 80



Code 128 Stitching

Enables/disables stitching for Code 128 labels. When parts of a Code 128 barcode are presented to the scanner with this feature enabled, the barcode parts will be assembled by the scanner's software, and the data will be decoded if all barcode proofing requirements are met.

To set this feature:

1. Scan the ENTER/EXIT Programming Mode bar code.
2. Scan your selection from the barcodes below. You'll need to cover any unused barcodes on this and the facing page to ensure that the scanner reads only the barcode you intend to scan.
3. Complete the programming sequence by scanning the ENTER/EXIT Programming Mode bar code.



Code 128 Stitching = Disable



★ Code 128 Stitching = Enable

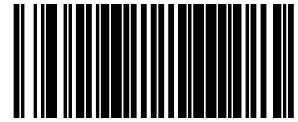

EAN-128 ENABLE

Enables/disables the ability of the scanner to translate EAN128 labels to the EAN128 data format.

To set this feature:

1. Scan the ENTER/EXIT Programming Mode bar code.
2. Scan either the enable or disable barcode below. You'll need to cover any unused barcodes on this and the facing page to ensure that the scanner reads only the barcode you intend to scan.
3. Complete the programming sequence by scanning the ENTER/EXIT Programming Mode bar code.



★ EAN-128 = Transmit EAN128 labels in Code128 data format



EAN-128 = Transmit EAN128 labels in EAN128 data format



INTERLEAVED 2 OF 5 (I 2 OF 5) ENABLE

Enables/disables the ability of the scanner to decode Interleaved 2 of 5 labels.

To set this feature:

1. Scan the ENTER/EXIT Programming Mode bar code.
2. Scan either the enable or disable barcode below. You'll need to cover any unused barcodes on this and the facing page to ensure that the scanner reads only the barcode you intend to scan.
3. Complete the programming sequence by scanning the ENTER/EXIT Programming Mode bar code.



★ I 2 of 5 = Disable



I 2 of 5 = Enable



I 2 of 5 Check Character Calculation

Enables/disables calculation and verification of an optional Interleaved 2 of 5 check character.



NOTE: If check character calculation is disabled, the risk is increased that a misread can occur. When disabled, any check characters in a barcode are treated as data characters.

1. To set this feature:
2. Scan the ENTER/EXIT Programming Mode bar code.
3. Scan either the enable or disable barcode below. You'll need to cover any unused barcodes on this and the facing page to ensure that the scanner reads only the barcode you intend to scan.
4. Complete the programming sequence by scanning the ENTER/EXIT Programming Mode bar code.



★ I 2 of 5 Check Character Calculation = Disable



I 2 of 5 Check Character Calculation = Enable



I 2 of 5 Check Character Transmission

Enables/disables transmission of an optional Interleaved 2 of 5 check character.



NOTE: This feature applies only when I 2 of 5 Check Character Calculation is enabled. This item is ignored when the advanced feature, Full Label Edit, is enabled.

To set this feature:

1. Scan the ENTER/EXIT Programming Mode bar code.
2. Scan either the enable or disable barcode below. You'll need to cover any unused barcodes on this and the facing page to ensure that the scanner reads only the barcode you intend to scan.
3. Complete the programming sequence by scanning the ENTER/EXIT Programming Mode bar code.



I 2 of 5 Check Character Transmission = Disable



★ I 2 of 5 Check Character Transmission = Enable



I 2 of 5 Minimum Read

This feature specifies the minimum number of consecutive I 2 of 5 decodes before is accepted as good read.

To set this feature:

1. Scan the ENTER/EXIT Programming Mode bar code.
2. Scan your selection from the bar codes below. You'll need to cover any unused bar codes on this and the facing page to ensure that the scanner reads only the bar code you intend to scan.
3. Complete the programming sequence by scanning the ENTER/EXIT Programming Mode bar code.



★ I 2 of 5 Minimum Read = 1



I 2 of 5 Minimum Read = 2



I 2 of 5 Minimum Read = 3



I 2 of 5 Minimum Read = 4



I 2 of 5 Correlation

Enables/disables character correlation for I 2 of 5.

To set this feature:

1. Scan the ENTER/EXIT Programming Mode bar code.
2. Scan either the enable or disable barcode below. You'll need to cover any unused barcodes on this and the facing page to ensure that the scanner reads only the barcode you intend to scan.
3. Complete the programming sequence by scanning the ENTER/EXIT Programming Mode bar code.



★ I 2 of 5 Correlation = Disable

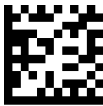

I 2 of 5 Correlation = Enable



I 2 of 5 Length Control

This feature specifies whether variable-length or fixed-length decoding will be set for I 2 of 5.

To set this feature:

1. Scan the ENTER/EXIT Programming Mode bar code.
2. Scan your selection from the barcodes below. You'll need to cover any unused barcodes on this and the facing page to ensure that the scanner reads only the barcode you intend to scan.
3. Complete the programming sequence by scanning the ENTER/EXIT Programming Mode bar code.



★ I 2 of 5 Length Control = Variable Length



I 2 of 5 Length Control = Fixed Length



I 2 of 5 Length 1

If I 2 of 5 Length Control is set to Fixed-Length decoding, this feature specifies I 2 of 5 first fixed length. If I 2 of 5 Length Control is set to Variable-Length decoding, this feature specifies the minimum label length.

To set this feature:

1. Scan the ENTER/EXIT Programming Mode bar code.
2. Scan the barcode, [Set I 2 of 5 Length 1](#) below. You'll need to cover any unused barcodes on this and the facing page to ensure that the scanner reads only the barcode you intend to scan.
3. Scan the appropriate digits from the [Keypad](#) in [Appendix C](#) that represent the desired label length. The selectable range for this option is 02 to 50, even numbers only. Pad all single digit numbers with a leading zero to yield a two-digit entry (02-50).
4. Complete the programming sequence by scanning the ENTER/EXIT Programming Mode bar code.



Set I 2 of 5 Length 1

★ Default setting for this feature = 06

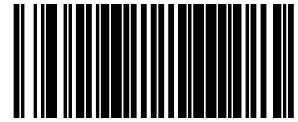

I 2 of 5 Length 2

If I 2 of 5 Length Control is set to Fixed-Length decoding, this feature specifies I 2 of 5 second fixed length. If I 2 of 5 Length Control is set to Variable-Length decoding, this feature specifies the maximum label length.



NOTE: When in Fixed Length mode, if Length 2 is set to the value of 00 (zero), then only Length 1 will apply.

To set this feature:

1. Scan the ENTER/EXIT Programming Mode bar code.
2. Scan the barcode, [Set I 2 of 5 Length 2](#) below. You'll need to cover any unused barcodes on this and the facing page to ensure that the scanner reads only the barcode you intend to scan.
3. Scan the appropriate digits from the [Keypad](#) in [Appendix C](#) that represent the desired label length. The selectable range for this option is 00, or 02 to 50; even numbers only. Pad all single digit numbers with a leading zero to yield a two-digit entry (02-50).
4. Complete the programming sequence by scanning the ENTER/EXIT Programming Mode bar code.



Set I 2 of 5 Length 2

★ Default setting for this feature = 50



I 2 of 5 Stitching

Enables/disables stitching for I 2 of 5 labels. When parts of an I 2 of 5 barcode are presented to the scanner with this feature enabled, the barcode parts will be assembled by the scanner's software, and the data will be decoded if all barcode proofing requirements are met.

To set this feature:

1. Scan the ENTER/EXIT Programming Mode bar code.
2. Scan your selection from the barcodes below. You'll need to cover any unused barcodes on this and the facing page to ensure that the scanner reads only the barcode you intend to scan.
3. Complete the programming sequence by scanning the ENTER/EXIT Programming Mode bar code.



★ I 2 of 5 Stitching = Disable



I 2 of 5 Stitching = Enable



CODABAR ENABLE

Enables/disables the ability of the scanner to decode Codabar labels.

To set this feature:

1. Scan the ENTER/EXIT Programming Mode bar code.
2. Scan either the enable or disable barcode below. You'll need to cover any unused barcodes on this and the facing page to ensure that the scanner reads only the barcode you intend to scan.
3. Complete the programming sequence by scanning the ENTER/EXIT Programming Mode bar code.



★ Codabar = Disable



Codabar = Enable



Codabar Start Stop Character Transmission

Enables/disables transmission of Codabar start and stop characters.



NOTE: This item is ignored when the advanced feature, Full Label Edit, is enabled.

To set this feature:

1. Scan the ENTER/EXIT Programming Mode bar code.
2. Scan either the enable or disable barcode below. You'll need to cover any unused barcodes on this and the facing page to ensure that the scanner reads only the barcode you intend to scan.
3. Complete the programming sequence by scanning the ENTER/EXIT Programming Mode bar code.



Codabar Start Stop Character Transmission = Disable



★ Codabar Start Stop Character Transmission = Enable



Codabar Start Stop Character Set

This feature specifies the format of transmitted Codabar start/stop characters.

Options are:

- ABCD/TN* E
- ABCD/ABCD
- abcd/tn* e
- abcd/abcd

To set this feature:

1. Scan the ENTER/EXIT Programming Mode bar code.
2. Scan the barcode below or from the following page representing the desired option. You'll need to cover any unused barcodes and facing pages to ensure that the scanner reads only the barcode you intend to scan.
3. Complete the programming sequence by scanning the ENTER/EXIT Programming Mode bar code.



Codabar Start Stop Character Set = ABCD/TN* E



Codabar Start Stop Character Set = ABCD/ABCD



Codabar Start Stop Character Set = abcd/tn* e



★ Codabar Start Stop Character Set = abcd/abcd



Codabar Start Stop Character Match

Enables/disables the requirement that start and stop characters match.

To set this feature:

1. Scan the ENTER/EXIT Programming Mode bar code.
2. Scan either the enable or disable barcode below. You'll need to cover any unused barcodes on this and the facing page to ensure that the scanner reads only the barcode you intend to scan.
3. Complete the programming sequence by scanning the ENTER/EXIT Programming Mode bar code.



★ Codabar Start Stop Character Match = Disable



Codabar Start Stop Character Match = Enable



Codabar Check Character Calculation

Enables/disables calculation and verification of an optional Codabar check character.



NOTE: If check character calculation is disabled, the risk is increased that a misread can occur. When disabled, any check characters in a barcode are treated as data characters.

To set this feature:

1. Scan the ENTER/EXIT Programming Mode bar code.
2. Scan either the enable or disable barcode below. You'll need to cover any unused barcodes on this and the facing page to ensure that the scanner reads only the barcode you intend to scan.
3. Complete the programming sequence by scanning the ENTER/EXIT Programming Mode bar code.



★ Codabar Check Character Calculation = Disable



Codabar Check Character Calculation = Enable



Codabar Check Character Transmission

Enables/disables transmission of an optional Codabar check character.



NOTE: Applies only when Codabar Check Character Calculation is enabled. This item is ignored when the advanced feature, Full Label Edit, is enabled.

To set this feature:

1. Scan the ENTER/EXIT Programming Mode bar code.
2. Scan either the enable or disable barcode below. You'll need to cover any unused barcodes on this and the facing page to ensure that the scanner reads only the barcode you intend to scan.
3. Complete the programming sequence by scanning the ENTER/EXIT Programming Mode bar code.



Codabar Check Character Transmission = Disable



★ Codabar Check Character Transmission = Enable



Codabar Minimum Read

This feature specifies the minimum number of consecutive Codabar decodes before is accepted as good read.

To set this feature:

1. Scan the ENTER/EXIT Programming Mode bar code.
2. Scan your selection from the bar codes below. You'll need to cover any unused bar codes on this and the facing page to ensure that the scanner reads only the bar code you intend to scan.
3. Complete the programming sequence by scanning the ENTER/EXIT Programming Mode bar code.



★ Codabar Minimum Read = 1



Codabar Minimum Read = 2



Codabar Minimum Read = 3



Codabar Minimum Read = 4



Codabar Correlation

Enables/disables character correlation for Codabar.

To set this feature:

1. Scan the ENTER/EXIT Programming Mode bar code.
2. Scan either the enable or disable barcode below. You'll need to cover any unused barcodes on this and the facing page to ensure that the scanner reads only the barcode you intend to scan.
3. Complete the programming sequence by scanning the ENTER/EXIT Programming Mode bar code.



★ Codabar Correlation = Disable



Codabar Correlation = Enable



Codabar Length Control

This feature specifies whether variable-length or fixed-length decoding will be set for Codabar.

To set this feature:

1. Scan the ENTER/EXIT Programming Mode bar code.
2. Scan your selection from the barcodes below. You'll need to cover any unused barcodes on this and the facing page to ensure that the scanner reads only the barcode you intend to scan.
3. Complete the programming sequence by scanning the ENTER/EXIT Programming Mode bar code.



★ Codabar Length Control = Variable Length



Codabar Length Control = Fixed Length

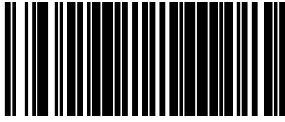

Codabar Length 1

If Codabar Length Control is set to Fixed-Length decoding, this feature specifies Codabar first fixed length. If Codabar Length Control is set to Variable-Length decoding, this feature specifies the minimum label length.

To set this feature:

1. Scan the ENTER/EXIT Programming Mode bar code.
2. Scan the barcode, [Set Codabar Length 1](#) below. You'll need to cover any unused barcodes on this and the facing page to ensure that the scanner reads only the barcode you intend to scan.
3. Scan the appropriate digits from the [Keypad](#) in [Appendix C](#) that represent the desired label length. The selectable range for this option is 03 to 50. Pad all single digit numbers with a leading zero to yield a two-digit entry (03-50).
4. Complete the programming sequence by scanning the ENTER/EXIT Programming Mode bar code.



Set Codabar Length 1

★ Default setting for this feature = 03



Codabar Length 2

If Codabar Length Control is set to Fixed-Length decoding, this feature specifies Codabar second fixed length. If Codabar Length Control is set to Variable-Length decoding, this feature specifies the maximum label length.



NOTE: When in Fixed Length mode, if Length 2 is set to the value of 00 (zero), then only Length 1 will apply.

To set this feature:

1. Scan the ENTER/EXIT Programming Mode bar code.
2. Scan the barcode, [Set Codabar Length 2](#) below. You'll need to cover any unused barcodes on this and the facing page to ensure that the scanner reads only the barcode you intend to scan.
3. Scan the appropriate digits from the [Keypad](#) in [Appendix C](#) that represent the desired label length. The selectable range for this option is 00 (meaning ignore this length), or 03 to 50. Pad all single digit numbers with a leading zero to yield a two-digit entry (03-50).
4. Complete the programming sequence by scanning the ENTER/EXIT Programming Mode bar code.



Set Codabar Length 2

★ Default setting for this feature = 50



Codabar Stitching

Enables/disables stitching for Codabar labels. When parts of a Codabar barcode are presented to the scanner with this feature enabled, the barcode parts will be assembled by the scanner's software, and the data will be decoded if all barcode proofing requirements are met.

To set this feature:

1. Scan the ENTER/EXIT Programming Mode bar code.
2. Scan your selection from the barcodes below. You'll need to cover any unused barcodes on this and the facing page to ensure that the scanner reads only the barcode you intend to scan.
3. Complete the programming sequence by scanning the ENTER/EXIT Programming Mode bar code.



★ Codabar Stitching = Disable



Codabar Stitching = Enable



Codabar Require Margins

Enables/disables the requirement that quiet zones be present in a Codabar bar code.

To set this feature:

1. Scan the ENTER/EXIT Programming Mode bar code.
2. Scan either the enable or disable bar code below. You'll need to cover any unused bar codes on this and the facing page to ensure that the scanner reads only the bar code you intend to scan.
3. Complete the programming sequence by scanning the ENTER/EXIT Programming Mode bar code.



★ Codabar Require Margins = Quiet Zones Not Required



Codabar Require Margins = Quiet Zones Required



CODE 93 ENABLE

Enables/disables the ability of the scanner to decode Code 93 labels.

To set this feature:

1. Scan the ENTER/EXIT Programming Mode bar code.
2. Scan either the enable or disable barcode below. You'll need to cover any unused barcodes on this and the facing page to ensure that the scanner reads only the barcode you intend to scan.
3. Complete the programming sequence by scanning the ENTER/EXIT Programming Mode bar code.



★ Code 93 = Disable



Code 93 = Enable



Code 93 Minimum Read

This feature specifies the minimum number of consecutive Code 93 decodes before is accepted as good read.

To set this feature:

1. Scan the ENTER/EXIT Programming Mode bar code.
2. Scan your selection from the bar codes below. You'll need to cover any unused bar codes on this and the facing page to ensure that the scanner reads only the bar code you intend to scan.
3. Complete the programming sequence by scanning the ENTER/EXIT Programming Mode bar code.



★ Code 93 Minimum Read = 1



Code 93 Minimum Read = 2



Code 93 Minimum Read = 3



Code 93 Minimum Read = 4



Code 93 Correlation

Enables/disables character correlation for Code 93.

To set this feature:

1. Scan the ENTER/EXIT Programming Mode bar code.
2. Scan either the enable or disable barcode below. You'll need to cover any unused barcodes on this and the facing page to ensure that the scanner reads only the barcode you intend to scan.
3. Complete the programming sequence by scanning the ENTER/EXIT Programming Mode bar code.



★ Code 93 Correlation = Disable



Code 93 Correlation = Enable



Code 93 Length Control

This feature specifies whether variable-length or fixed-length decoding will be set for Code 93.

To set this feature:

1. Scan the ENTER/EXIT Programming Mode bar code.
2. Scan your selection from the barcodes below. You'll need to cover any unused barcodes on this and the facing page to ensure that the scanner reads only the barcode you intend to scan.
3. Complete the programming sequence by scanning the ENTER/EXIT Programming Mode bar code.



★ Codabar Length Control = Variable Length



Codabar Length Control = Fixed Length

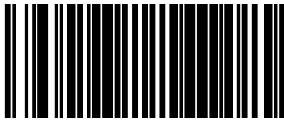

Code 93 Length 1

If Code 93 Length Control is set to Fixed-Length decoding, this feature specifies Code 93 first fixed length. If Code 93 Length Control is set to Variable-Length decoding, this feature specifies the minimum label length.

To set this feature:

1. Scan the ENTER/EXIT Programming Mode bar code.
2. Scan the barcode, [Set Code 93 Length 1](#) below. You'll need to cover any unused barcodes on this and the facing page to ensure that the scanner reads only the barcode you intend to scan.
3. Scan the appropriate digits from the [Keypad](#) in [Appendix C](#) that represent the desired label length. The selectable range for this option is 01 to 50. Pad all single digit numbers with a leading zero to yield a two-digit entry (01-50).
4. Complete the programming sequence by scanning the ENTER/EXIT Programming Mode bar code.



Set Code 93 Length 1

★ Default setting for this feature = 01



Code 93 Length 2

If Code 93 Length Control is set to Fixed-Length decoding, this feature specifies Code 93 second fixed length. If Code 93 Length Control is set to Variable-Length decoding, this feature specifies the maximum label length.



NOTE: When in Fixed Length mode, if Fixed Length 2 is set to the value of 00 (zero), then only Length 1 will apply.

To set this feature:

1. Scan the ENTER/EXIT Programming Mode bar code.
2. Scan the barcode, [Set Code 93 Length 2](#) below. You'll need to cover any unused barcodes on this and the facing page to ensure that the scanner reads only the barcode you intend to scan.
3. Scan the appropriate digits from the [Keypad](#) in [Appendix C](#) that represent the desired label length. The selectable range for this option is 00 (meaning ignore this length), or 01 to 50. Pad all single digit numbers with a leading zero to yield a two-digit entry (01-50).
4. Complete the programming sequence by scanning the ENTER/EXIT Programming Mode bar code.



Set Code 93 Length 2

★ Default setting for this feature = 50



Code 93 Stitching

Enables/disables stitching for Code 93 labels. When parts of a Code 93 barcode are presented to the scanner with this feature enabled, the barcode parts will be assembled by the scanner's software, and the data will be decoded if all barcode proofing requirements are met.

To set this feature:

1. Scan the ENTER/EXIT Programming Mode bar code.
2. Scan your selection from the barcodes below. You'll need to cover any unused barcodes on this and the facing page to ensure that the scanner reads only the barcode you intend to scan.
3. Complete the programming sequence by scanning the ENTER/EXIT Programming Mode bar code.



Code 93 Stitching = Disable



★ Code 93 Stitching = Enable



MSI ENABLE

Enables/disables the ability of the scanner to decode MSI labels.

To set this feature:

1. Scan the ENTER/EXIT Programming Mode bar code.
2. Scan either the enable or disable barcode below. You'll need to cover any unused barcodes on this and the facing page to ensure that the scanner reads only the barcode you intend to scan.
3. Complete the programming sequence by scanning the ENTER/EXIT Programming Mode bar code.



★ MSI = Disable



MSI = Enable



MSI Check Character Calculation

Enables/disables calculation and verification of optional MSI check characters.



NOTE: If check character calculation is disabled, the risk is increased that a misread can occur. When disabled, any check characters in a barcode are treated as data characters.

To set this feature:

1. Scan the ENTER/EXIT Programming Mode bar code.
2. Scan either the enable or disable barcode below. You'll need to cover any unused barcodes on this and the facing page to ensure that the scanner reads only the barcode you intend to scan.
3. Complete the programming sequence by scanning the ENTER/EXIT Programming Mode bar code.



MSI Check Character Calculation = Disable



★ MSI Check Character Calculation = Enable



MSI Number of Check Characters

Specifies number of MSI check characters to be calculated and verified.



NOTE: Check characters are always modulus 10.

To set this feature:

1. Scan the ENTER/EXIT Programming Mode bar code.
2. Scan the barcode below representing the desired number of MSI check characters to be calculated and verified. You'll need to cover any unused barcodes on this and the facing page to ensure that the scanner reads only the barcode you intend to scan.
3. Complete the programming sequence by scanning the ENTER/EXIT Programming Mode bar code.



★ MSI Number of Check Characters = 1



MSI Number of Check Characters = 2



MSI Check Character Transmission

Enables/disables transmission of optional MSI check characters.



NOTE: This feature applies only when MSI Check Character Calculation is enabled. This item is ignored when the advanced feature, Full Label Edit, is enabled.

To set this feature:

1. Scan the ENTER/EXIT Programming Mode bar code.
2. Scan either the enable or disable barcode below. You'll need to cover any unused barcodes on this and the facing page to ensure that the scanner reads only the barcode you intend to scan.
3. Complete the programming sequence by scanning the ENTER/EXIT Programming Mode bar code.



MSI Check Character Transmission = Disable



★ MSI Check Character Transmission = Enable



MSI Minimum Read

This feature specifies the minimum number of consecutive MSI decodes before is accepted as good read.

To set this feature:

1. Scan the ENTER/EXIT Programming Mode bar code.
2. Scan your selection from the bar codes below. You'll need to cover any unused bar codes on this and the facing page to ensure that the scanner reads only the bar code you intend to scan.
3. Complete the programming sequence by scanning the ENTER/EXIT Programming Mode bar code.



★ MSI Minimum Read = 1



MSI Minimum Read = 2



MSI Minimum Read = 3



MSI Minimum Read = 4



MSI Correlation

Enables/disables character correlation for MSI.

To set this feature:

1. Scan the ENTER/EXIT Programming Mode bar code.
2. Scan either the enable or disable barcode below. You'll need to cover any unused barcodes on this and the facing page to ensure that the scanner reads only the barcode you intend to scan.
3. Complete the programming sequence by scanning the ENTER/EXIT Programming Mode bar code.



★ MSI Correlation = Disable



MSI Correlation = Enable



MSI Length Control

This feature specifies whether variable-length or fixed-length decoding will be set for MSI.

To set this feature:

1. Scan the ENTER/EXIT Programming Mode bar code.
2. Scan your selection from the barcodes below. You'll need to cover any unused barcodes on this and the facing page to ensure that the scanner reads only the barcode you intend to scan.
3. Complete the programming sequence by scanning the ENTER/EXIT Programming Mode bar code.



★ MSI Length Control = Variable Length



MSI Length Control = Fixed Length

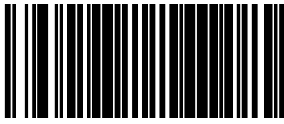

MSI Length 1

If MSI Length Control is set to Fixed-Length decoding, this feature specifies MSI first fixed length. If MSI Length Control is set to Variable-Length decoding, this feature specifies the minimum label length.

To set this feature:

1. Scan the ENTER/EXIT Programming Mode bar code.
2. Scan the barcode, [Set MSI Length 1](#) below. You'll need to cover any unused barcodes on this and the facing page to ensure that the scanner reads only the barcode you intend to scan.
3. Scan the appropriate digits from the [Keypad](#) in [Appendix C](#) that represent the desired label length. The selectable range for this option is 4 to 16. Pad all single digit numbers with a leading zero to yield a two-digit entry (04-16).
4. Complete the programming sequence by scanning the ENTER/EXIT Programming Mode bar code.



Set MSI Length 1

★ Default setting for this feature = 04



MSI Length 2

If MSI Length Control is set to Fixed-Length decoding, this feature specifies MSI second fixed length. If MSI Length Control is set to Variable-Length decoding, this feature specifies the maximum label length.



NOTE: When in Fixed Length mode, if Length 2 is set to the value 00 (zero), then only Length 1 will apply.

To set this feature:

1. Scan the ENTER/EXIT Programming Mode bar code.
2. Scan the barcode, [Set MSI Length 2](#) below. You'll need to cover any unused barcodes on this and the facing page to ensure that the scanner reads only the barcode you intend to scan.
3. Scan the appropriate digits from the [Keypad](#) in [Appendix C](#) that represent the desired label length. The selectable range for this option is 00 (meaning ignore this length), or 04 to 16. Pad all single digit numbers with a leading zero to yield a two-digit entry (00, 04-16).
4. Complete the programming sequence by scanning the ENTER/EXIT Programming Mode bar code.



Set MSI Length 2

★ Default setting for this feature = 16



MSI Stitching

Enables/disables stitching for MSI labels. When parts of an MSI barcode are presented to the scanner with this feature enabled, the barcode parts will be assembled by the scanner's software, and the data will be decoded if all barcode proofing requirements are met.

To set this feature:

1. Scan the ENTER/EXIT Programming Mode bar code.
2. Scan your selection from the barcodes below. You'll need to cover any unused barcodes on this and the facing page to ensure that the scanner reads only the barcode you intend to scan.
3. Complete the programming sequence by scanning the ENTER/EXIT Programming Mode bar code.



★ MSI Stitching = Disable



MSI Stitching = Enable



STANDARD 2 OF 5 ENABLE

Enables/disables the ability of the scanner to decode Standard 2 of 5 labels.

To set this feature:

1. Scan the ENTER/EXIT Programming Mode bar code.
2. Scan either the enable or disable barcode below. You'll need to cover any unused barcodes on this and the facing page to ensure that the scanner reads only the barcode you intend to scan.
3. Complete the programming sequence by scanning the ENTER/EXIT Programming Mode bar code.



★ Standard 2 of 5 = Disable



Standard 2 of 5 = Enable



Standard 2 of 5 Check Character Calculation

Enables/disables calculation and verification of an optional Standard 2 of 5 check character.



NOTE: If check character calculation is disabled, the risk is increased that a misread can occur. When disabled, any check character in a barcode is treated as data character.

To set this feature:

1. Scan the ENTER/EXIT Programming Mode bar code.
2. Scan either the enable or disable barcode below. You'll need to cover any unused barcodes on this and the facing page to ensure that the scanner reads only the barcode you intend to scan.
3. Complete the programming sequence by scanning the ENTER/EXIT Programming Mode bar code.



★ Standard 2 of 5 Check Character Calculation = Disable



Standard 2 of 5 Check Character Calculation = Enable

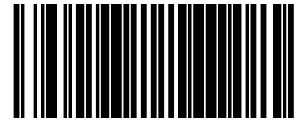

Standard 2 of 5 Check Character Transmission

Enables/disables transmission of an optional Standard 2 of 5 check character.



NOTE: This feature applies only when Standard 2 of 5 Check Character Calculation is enabled. This item is ignored when the advanced feature, Full Label Edit, is enabled.

To set this feature:

1. Scan the ENTER/EXIT Programming Mode bar code.
2. Scan either the enable or disable barcode below. You'll need to cover any unused barcodes on this and the facing page to ensure that the scanner reads only the barcode you intend to scan.
3. Complete the programming sequence by scanning the ENTER/EXIT Programming Mode bar code.



Standard 2 of 5 Check Character Transmission = Disable



★ Standard 2 of 5 Check Character Transmission = Enable



Standard 2 of 5 Minimum Read

This feature specifies the minimum number of consecutive Standard 2 of 5 decodes before is accepted as good read.

To set this feature:

1. Scan the ENTER/EXIT Programming Mode bar code.
2. Scan your selection from the bar codes below. You'll need to cover any unused bar codes on this and the facing page to ensure that the scanner reads only the bar code you intend to scan.
3. Complete the programming sequence by scanning the ENTER/EXIT Programming Mode bar code.



★ Standard 2 of 5 Minimum Read = 1



Standard 2 of 5 Minimum Read = 2



Standard 2 of 5 Minimum Read = 3



Standard 2 of 5 Minimum Read = 4

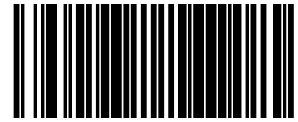

Standard 2 of 5 Correlation

Enables/disables character correlation for Standard 2 of 5.

To set this feature:

1. Scan the ENTER/EXIT Programming Mode bar code.
2. Scan either the enable or disable barcode below. You'll need to cover any unused barcodes on this and the facing page to ensure that the scanner reads only the barcode you intend to scan.
3. Complete the programming sequence by scanning the ENTER/EXIT Programming Mode bar code.



★ Standard 2 of 5 Correlation = Disable



Standard 2 of 5 Correlation = Enable



Standard 2 of 5 Length Control

This feature specifies whether variable-length or fixed-length decoding will be set for Standard 2 of 5.

To set this feature:

1. Scan the ENTER/EXIT Programming Mode bar code.
2. Scan your selection from the barcodes below. You'll need to cover any unused barcodes on this and the facing page to ensure that the scanner reads only the barcode you intend to scan.
3. Complete the programming sequence by scanning the ENTER/EXIT Programming Mode bar code.



★ Standard 2 of 5 Length Control = Variable Length

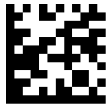

Standard 2 of 5 Length Control = Fixed Length



Standard 2 of 5 Length 1

If Standard 2 of 5 Length Control is set to Fixed-Length decoding, this feature specifies Standard 2 of 5 first fixed length. If Standard 2 of 5 Length Control is set to Variable-Length decoding, this feature specifies the minimum label length.

To set this feature:

1. Scan the ENTER/EXIT Programming Mode bar code.
2. Scan the barcode, [Set Standard 2 of 5 Length 1](#) below. You'll need to cover any unused barcodes on this and the facing page to ensure that the scanner reads only the barcode you intend to scan.
3. Scan the appropriate digits from the [Keypad](#) in [Appendix C](#) that represent the desired label length. The selectable range for this option is 1 to 50. Pad all single digit numbers with a leading zero to yield a two-digit entry (01-50).
4. Complete the programming sequence by scanning the ENTER/EXIT Programming Mode bar code.



Set Standard 2 of 5 Length 1

★ Default setting for this feature = 08

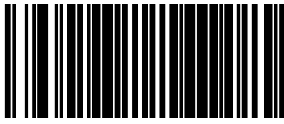

Standard 2 of 5 Length 2

If Standard 2 of 5 Length Control is set to Fixed-Length decoding, this feature specifies Standard 2 of 5 second fixed length. If Standard 2 of 5 Length Control is set to Variable-Length decoding, this feature specifies the maximum label length.



NOTE: When in Fixed Length mode, if Length 2 is set to the value of 00 (zero), then only Length 1 will apply.

To set this feature:

1. Scan the ENTER/EXIT Programming Mode bar code.
2. Scan the barcode, [Set Standard 2 of 5 Length 2](#) below. You'll need to cover any unused barcodes on this and the facing page to ensure that the scanner reads only the barcode you intend to scan.
3. Scan the appropriate digits from the [Keypad](#) in [Appendix C](#) that represent the desired label length. The selectable range for this option is 1 to 50. Pad all single digit numbers with a leading zero to yield a two-digit entry (01-50).
4. Complete the programming sequence by scanning the ENTER/EXIT Programming Mode bar code.



Set Standard 2 of 5 Length 2

★ Default setting for this feature = 50



Standard 2 of 5 Stitching

Enables/disables stitching for Standard 2 of 5 labels. When parts of a Standard 2 of 5 barcode are presented to the scanner with this feature enabled, the barcode parts will be assembled by the scanner's software, and the data will be decoded if all barcode proofing requirements are met.



NOTE: This applies when Standard 2 of 5 Length Control is set to fixed-length decoding.

To set this feature:

1. Scan the ENTER/EXIT Programming Mode bar code.
2. Scan your selection from the barcodes below. You'll need to cover any unused barcodes on this and the facing page to ensure that the scanner reads only the barcode you intend to scan.
3. Complete the programming sequence by scanning the ENTER/EXIT Programming Mode bar code.



★ Standard 2 of 5 Stitching = Disable



Standard 2 of 5 Stitching = Enable

NOTES

2D SYMBOLOGY PROGRAMMING

2D SYMBOLOGIES



NOTE: If the scanner’s interface type must be changed, always be sure that interface configuration is the **FIRST** item scanned during a programming session. (Selecting an interface type resets **ALL** other configuration items — including symbology programming — to the factory default for that interface type.)

The following pages contain configuration information concerning the various 2D bar code types (symbologies) the scanner supports.

SECTION CONTENTS	
DATA MATRIX ENABLE starting on page 380	GS1 QR CODE ENABLE starting on page 395
PDF 417 ENABLE starting on page 384	MICRO QR CODE ENABLE starting on page 397
MICRO PDF 417 ENABLE starting on page 388	AZTEC ENABLE starting on page 400
QR CODE ENABLE starting on page 392	



DATA MATRIX ENABLE

Enables/disables the ability of the scanner to decode Data Matrix labels.

To set this feature:

1. Scan the Enter/Exit Programming Mode bar code.
2. Scan either the enable or disable bar code below. You'll need to cover any unused bar codes on this and the facing page to ensure that the scanner reads only the bar code you intend to scan.
3. Complete the programming sequence by scanning the Enter/Exit Programming Mode bar code.



★ Data Matrix = Disable



Data Matrix = Enable



Data Matrix Length Control

Fixed Length Decoding: When fixed length decoding is enabled, the scanner will decode a bar code if the label length matches one of the configurable fixed lengths.

Variable Length Decoding: When variable length decoding is enabled, the scanner will decode a ar code if the label length falls in the range of the configurable minimum and maximum length.

Configuring Fixed Length Decoding:

1. Scan the ENTER/EXIT Programming Mode bar code.
2. Scan the Fixed Length Decoding bar code.
3. Scan the ENTER/EXIT Programming Mode bar code.
4. Set Length 1 to the first fixed length using the [Data Matrix Length 1, Length 2 Programming Instructions](#) that follow this page.
5. Set Length 2 to the second fixed length (or to '0000' if there is only one fixed length) using the [Data Matrix Length 1, Length 2 Programming Instructions](#).

Configuring Variable Length Decoding:

1. Scan the ENTER/EXIT Programming Mode bar code.
2. Scan the Variable Length Decoding bar code.
3. Scan the ENTER/EXIT Programming Mode bar code.
4. Set Length 1 to the minimum length using the [Data Matrix Length 1, Length 2 Programming Instructions](#) that follow this page.
5. Set Length 2 to the maximum length using the [Data Matrix Length 1, Length 2 Programming Instructions](#).



★ Data Matrix Length Control = Variable Length



Data Matrix Length Control = Fixed Length



Data Matrix Length 1, Length 2 Programming Instructions

If Data Matrix Length Control is set to Fixed-Length decoding, this feature specifies Data Matrix first fixed length. If Data Matrix Length Control is set to Variable-Length decoding, this feature specifies the minimum label length.



NOTE: For Data Matrix bar codes, only the data characters are included in the length calculations.

To set this feature:

1. Scan the ENTER/EXIT Programming Mode bar code.
2. Scan the barcode, [Set Data Matrix Length 1](#) or [Set Data Matrix Length 2](#) below. You'll need to cover any unused barcodes on this and the facing page to ensure that the scanner reads only the bar code you intend to scan.
3. Scan the appropriate digits from the [Keypad](#) in [Appendix C](#) that represent the desired label length. The selectable range for this option is 0001 to 3116. Pad all numbers with leading zeros to yield a four-digit entry (0001-3116).
4. Complete the programming sequence by scanning the ENTER/EXIT Programming Mode bar code.

Default setting for this feature = 0001



Set Data Matrix Length 1



Set Data Matrix Length 2

Default setting for this feature = 0800



GS1 Datamatrix Enable

Enables/disables the ability of the scanner to decode GS1 Datamatrix labels.

To set this feature:

1. Scan the Enter/Exit Programming Mode bar code.
2. Scan either the enable or disable bar code below. You'll need to cover any unused bar codes on this and the facing page to ensure that the scanner reads only the bar code you intend to scan.
3. Complete the programming sequence by scanning the Enter/Exit Programming Mode bar code.



★ GS1 Datamatrix disabled



GS1 Datamatrix enabled



PDF 417 ENABLE

Enables the processing of PDF417 labels read by the scanner.

To set this feature:

1. Scan the Enter/Exit Programming Mode bar code.
2. Scan either the enable or disable bar code below. You'll need to cover any unused bar codes on this and the facing page to ensure that the scanner reads only the bar code you intend to scan.
3. Complete the programming sequence by scanning the Enter/Exit Programming Mode bar code.



PDF 417 = Disable



★ PDF 417 = Enable



PDF 417 Length Control

Fixed Length Decoding: When fixed length decoding is enabled, the scanner will decode a bar code if the label length matches one of the configurable fixed lengths.

Variable Length Decoding: When variable length decoding is enabled, the scanner will decode a bar code if the label length falls in the range of the configurable minimum and maximum length.

Configuring Fixed Length Decoding:

1. Scan the ENTER/EXIT Programming Mode bar code.
2. Scan the Fixed Length Decoding bar code.
3. Scan the ENTER/EXIT Programming Mode bar code.
4. Set Length 1 to the first fixed length using the [PDF 417 Length 1, Length 2 Programming Instructions](#) that follow this page.
5. Set Length 2 to the second fixed length (or to '0000' if there is only one fixed length) using the [PDF 417 Length 1, Length 2 Programming Instructions](#).

Configuring Variable Length Decoding:

1. Scan the ENTER/EXIT Programming Mode bar code.
2. Scan the Variable Length Decoding bar code.
3. Scan the ENTER/EXIT Programming Mode bar code.
4. Set Length 1 to the minimum length using the [PDF 417 Length 1, Length 2 Programming Instructions](#) that follow this page.
5. Set Length 2 to the maximum length using the [PDF 417 Length 1, Length 2 Programming Instructions](#).



★ PDF 417 Length Control = Variable Length



PDF 417 Length Control = Fixed Length



PDF 417 Length 1, Length 2 Programming Instructions

If PDF417 Length Control is set to Fixed-Length decoding, this feature specifies PDF417 first fixed length. If PDF417 Length Control is set to Variable-Length decoding, this feature specifies the minimum label length.



NOTE: This tag is only valid for units with a model ID that supports PDF.

Length 1 is the minimum label length if in variable length mode, or the first fixed length if in fixed length mode. Length 2 is the maximum label length if in variable length mode, or the second fixed length if in fixed length mode. Length includes the barcode's data characters only. Any value > 2710 will be considered to be 2710.

To set this feature:

1. Scan the ENTER/EXIT Programming Mode bar code.
2. Scan the barcode, [Set PDF 417 Length 1](#) or [Set PDF 417 Length 2](#) below. You'll need to cover any unused barcodes on this and the facing page to ensure that the scanner reads only the bar code you intend to scan.
3. Scan the appropriate digits from the [Keypad](#) in [Appendix C](#) that represent the desired label length. The selectable range for this option is 0001 to 2710. Pad all numbers with leading zeros to yield a four-digit entry (0001-2710).
4. Complete the programming sequence by scanning the ENTER/EXIT Programming Mode bar code.

Default setting for this feature = 0001



Set PDF 417 Length 1



Set PDF 417 Length 2

Default setting for this feature = 2710

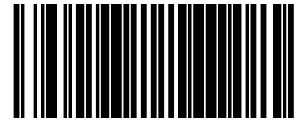

PDF 417 Read Option

This feature specifies an additional read control option for PDF 417 bar codes.

To set this feature:

1. Scan the Enter/Exit Programming Mode bar code.
2. Scan either the enable or disable bar code below. You'll need to cover any unused bar codes on this and the facing page to ensure that the scanner reads only the bar code you intend to scan.
3. Complete the programming sequence by scanning the Enter/Exit Programming Mode bar code.



★ PDF 417 Read Option = None



PDF 417 Read Option = Turn Off Codeword
Length Checking



MICRO PDF 417 ENABLE

Enables/disables the ability of the scanner to decode Micro PDF 417 labels.

To set this feature:

1. Scan the Enter/Exit Programming Mode bar code.
2. Scan either the enable or disable bar code below. You'll need to cover any unused bar codes on this and the facing page to ensure that the scanner reads only the bar code you intend to scan.
3. Complete the programming sequence by scanning the Enter/Exit Programming Mode bar code.



★ Micro PDF 417 = Disable



Micro PDF 417 = Enable

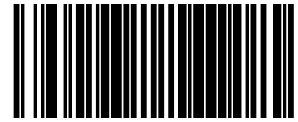

Micro PDF 417 Length Control

Fixed Length Decoding: When fixed length decoding is enabled, the scanner will decode a bar code if the label length matches one of the configurable fixed lengths.

Variable Length Decoding: When variable length decoding is enabled, the scanner will decode a ar code if the label length falls in the range of the configurable minimum and maximum length.

Configuring Fixed Length Decoding:

1. Scan the ENTER/EXIT Programming Mode bar code.
2. Scan the Fixed Length Decoding bar code.
3. Scan the ENTER/EXIT Programming Mode bar code.
4. Set Length 1 to the first fixed length using the [Micro PDF 417 Length 1, Length 2 Programming Instructions](#) that follow this page.
5. Set Length 2 to the second fixed length (or to '0000' if there is only one fixed length) using the [Micro PDF 417 Length 1, Length 2 Programming Instructions](#).

Configuring Variable Length Decoding:

1. Scan the ENTER/EXIT Programming Mode bar code.
2. Scan the Variable Length Decoding bar code.
3. Scan the ENTER/EXIT Programming Mode bar code.
4. Set Length 1 to the minimum length using the [Micro PDF 417 Length 1, Length 2 Programming Instructions](#) that follow this page.
5. Set Length 2 to the maximum length using the [Micro PDF 417 Length 1, Length 2 Programming Instructions](#).



★ Micro PDF 417 Length Control = Variable Length



Micro PDF 417 Length Control = Fixed Length

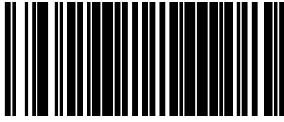

Micro PDF 417 Length 1, Length 2 Programming Instructions

If Micro PDF 417 Length Control is set to Fixed-Length decoding, this feature specifies Micro PDF 417 first fixed length. If Micro PDF 417 Length Control is set to Variable-Length decoding, this feature specifies the minimum label length.



NOTE: This tag is only valid for units with a model ID that supports PDF.

Length 1 is the minimum label length if in variable length mode, or the first fixed length if in fixed length mode. Length 2 is the maximum label length if in variable length mode, or the second fixed length if in fixed length mode. Length includes the barcode's data characters only. Any value > 0366 will be considered to be 0366.

To set this feature:

1. Scan the ENTER/EXIT Programming Mode bar code.
2. Scan the barcode, [Set Micro PDF 417 Length 1](#) or [Set Micro PDF 417 Length 2](#) below. You'll need to cover any unused barcodes on this and the facing page to ensure that the scanner reads only the bar code you intend to scan.
3. Scan the appropriate digits from the [Keypad](#) in [Appendix C](#) that represent the desired label length. The selectable range for this option is 0001 to 0366. Pad all numbers with leading zeros to yield a four-digit entry (0001-0366).
4. Complete the programming sequence by scanning the ENTER/EXIT Programming Mode bar code.

Default setting for this feature = 0001



Set Micro PDF 417 Length 1



Set Micro PDF 417 Length 2

Default setting for this feature = 0366



Micro PDF 417 128 Emulation

This feature specifies which AIM ID to use for Micro PDF 417 labels when performing Code 128 or EAN 128 emulation.

To set this feature:

1. Scan the Enter/Exit Programming Mode bar code.
2. Scan the bar code below for the desired setting. You'll need to cover any unused bar codes on this and the facing page to ensure that the scanner reads only the bar code you intend to scan.
3. Complete the programming sequence by scanning the Enter/Exit Programming Mode bar code.



★ Micro PDF 417 128 Emulation = Micro PDF AIM ID and label type when emulating EAN128 or Code 128



Micro PDF 417 128 Emulation = Code 128 / EAN128
AIM ID and label type when emulating EAN128 or Code
128



QR CODE ENABLE

Enables/disables the ability of the scanner to decode QRCode labels.

To set this feature:

1. Scan the Enter/Exit Programming Mode bar code.
2. Scan either the enable or disable bar code below. You'll need to cover any unused bar codes on this and the facing page to ensure that the scanner reads only the bar code you intend to scan.
3. Complete the programming sequence by scanning the Enter/Exit Programming Mode bar code.



★ QR Code = Disable



QR Code = Enable



QR Code Length Control

Fixed Length Decoding: When fixed length decoding is enabled, the scanner will decode a bar code if the label length matches one of the configurable fixed lengths.

Variable Length Decoding: When variable length decoding is enabled, the scanner will decode a QR code if the label length falls in the range of the configurable minimum and maximum length.

Configuring Fixed Length Decoding:

1. Scan the ENTER/EXIT Programming Mode bar code.
2. Scan the Fixed Length Decoding bar code.
3. Scan the ENTER/EXIT Programming Mode bar code.
4. Set Length 1 to the first fixed length using the [QR Code Length 1, Length 2 Programming Instructions](#) that follow this page.
5. Set Length 2 to the second fixed length (or to '0000' if there is only one fixed length) using the [QR Code Length 1, Length 2 Programming Instructions](#).

Configuring Variable Length Decoding:

1. Scan the ENTER/EXIT Programming Mode bar code.
2. Scan the Variable Length Decoding bar code.
3. Scan the ENTER/EXIT Programming Mode bar code.
4. Set Length 1 to the minimum length using the [QR Code Length 1, Length 2 Programming Instructions](#) that follow this page.
5. Set Length 2 to the maximum length using the [QR Code Length 1, Length 2 Programming Instructions](#).



★ QR Code Length Control = Variable Length



QR Code Length Control = Fixed Length



QR Code Length 1, Length 2 Programming Instructions

If QR Code Length Control is set to Fixed-Length decoding, this feature specifies QR Code first fixed length. If QR Code Length Control is set to Variable-Length decoding, this feature specifies the minimum label length.



NOTE: Length 1 is the minimum label length if in variable length mode, or the first fixed length if in fixed length mode. Length 2 is the maximum label length if in variable length mode, or the second fixed length if in fixed length mode. Length includes the barcode's data characters only. Any value > 2710 will be considered to be 2710.

To set this feature:

1. Scan the ENTER/EXIT Programming Mode bar code.
2. Scan the barcode, [Set QR Code Length 1](#) or [Set QR Code Length 2](#) below. You'll need to cover any unused barcodes on this and the facing page to ensure that the scanner reads only the bar code you intend to scan.
3. Scan the appropriate digits from the [Keypad](#) in [Appendix C](#) that represent the desired label length. The selectable range for this option is 0001 to 2710. Pad all numbers with leading zeros to yield a four-digit entry (001-02710).
4. Complete the programming sequence by scanning the ENTER/EXIT Programming Mode bar code.

Default setting for this feature = 0001



Set QR Code Length 1



Set QR Code Length 2

Default setting for this feature = 2710



GS1 QR Code Enable

This feature controls the ability of the scanner to decode GS1 QR Code labels.

To set this feature:

1. Scan the Enter/Exit Programming Mode bar code.
2. Scan either the enable or disable bar code below. You'll need to cover any unused bar codes on this and the facing page to ensure that the scanner reads only the bar code you intend to scan.
3. Complete the programming sequence by scanning the Enter/Exit Programming Mode bar code.



★ GS1 QR Code = Disable



GS1 QR Code = Enable



QR Code URL Link Enable

Enables/Disables the decoding of QR codes with a URL link on imagers other than the optional Customer Service Scanner (CSS).

To set this feature:

1. Scan the Enter/Exit Programming Mode bar code.
2. Scan either the enable or disable bar code below. You'll need to cover any unused bar codes on this and the facing page to ensure that the scanner reads only the bar code you intend to scan.
3. Complete the programming sequence by scanning the Enter/Exit Programming Mode bar code.



★ QR Code URL Link = Disable



QR Code URL Link = Enable



MICRO QR CODE ENABLE

Enables/disables the ability of the scanner to decode Micro QRCode labels.

To set this feature:

1. Scan the Enter/Exit Programming Mode bar code.
2. Scan either the enable or disable bar code below. You'll need to cover any unused bar codes on this and the facing page to ensure that the scanner reads only the bar code you intend to scan.
3. Complete the programming sequence by scanning the Enter/Exit Programming Mode bar code.



★ Micro QR Code = Disable



Micro QR Code = Enable

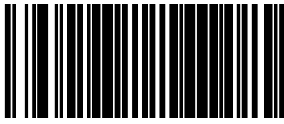

Micro QR Code Length Control

Fixed Length Decoding: When fixed length decoding is enabled, the scanner will decode a bar code if the label length matches one of the configurable fixed lengths.

Variable Length Decoding: When variable length decoding is enabled, the scanner will decode a ar code if the label length falls in the range of the configurable minimum and maximum length.

Configuring Fixed Length Decoding:

1. Scan the ENTER/EXIT Programming Mode bar code.
2. Scan the Fixed Length Decoding bar code.
3. Scan the ENTER/EXIT Programming Mode bar code.
4. Set Length 1 to the first fixed length using the [Micro QR Code Length 1, Length 2 Programming Instructions](#) that follow this page.
5. Set Length 2 to the second fixed length (or to '0000' if there is only one fixed length) using the [Micro QR Code Length 1, Length 2 Programming Instructions](#).

Configuring Variable Length Decoding:

1. Scan the ENTER/EXIT Programming Mode bar code.
2. Scan the Variable Length Decoding bar code.
3. Scan the ENTER/EXIT Programming Mode bar code.
4. Set Length 1 to the minimum length using the [Micro QR Code Length 1, Length 2 Programming Instructions](#) that follow this page.
5. Set Length 2 to the maximum length using the [Micro QR Code Length 1, Length 2 Programming Instructions](#).



★ Micro QR Code Length Control = Variable Length



Micro QR Code Length Control = Fixed Length



Micro QR Code Length 1, Length 2 Programming Instructions

If Micro QR Code Length Control is set to Fixed-Length decoding, this feature specifies Micro QR Code first fixed length. If Micro QR Code Length Control is set to Variable-Length decoding, this feature specifies the minimum label length.



NOTE: Length 1 is the minimum label length if in variable length mode, or the first fixed length if in fixed length mode. Length 2 is the maximum label length if in variable length mode, or the second fixed length if in fixed length mode. Length includes the barcode's data characters only. Any value > 3700 will be considered to be 3700.

To set this feature:

1. Scan the ENTER/EXIT Programming Mode bar code.
2. Scan the barcode, [Set Aztec Length 1](#) or [Set Micro QR Code Length 2](#) below. You'll need to cover any unused barcodes on this and the facing page to ensure that the scanner reads only the bar code you intend to scan.
3. Scan the appropriate digits from the [Keypad](#) in [Appendix C](#) that represent the desired label length. The selectable range for this option is 0001 to 3700. Pad all numbers with leading zeros to yield a four-digit entry (0001-3700).
4. Complete the programming sequence by scanning the ENTER/EXIT Programming Mode bar code.

Default setting for this feature = 0001



Set Micro QR Code Length 1



Set Micro QR Code Length 2

Default setting for this feature = 3700



AZTEC ENABLE

Enables/disables the ability of the scanner to decode Aztec labels.

To set this feature:

1. Scan the Enter/Exit Programming Mode bar code.
2. Scan either the enable or disable bar code below. You'll need to cover any unused bar codes on this and the facing page to ensure that the scanner reads only the bar code you intend to scan.
3. Complete the programming sequence by scanning the Enter/Exit Programming Mode bar code.



★ Aztec = Disable



Aztec = Enable

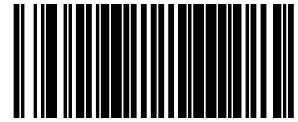

Aztec Length Control

Fixed Length Decoding: When fixed length decoding is enabled, the scanner will decode a bar code if the label length matches one of the configurable fixed lengths.

Variable Length Decoding: When variable length decoding is enabled, the scanner will decode a bar code if the label length falls in the range of the configurable minimum and maximum length.

Configuring Fixed Length Decoding:

1. Scan the ENTER/EXIT Programming Mode bar code.
2. Scan the Fixed Length Decoding bar code.
3. Scan the ENTER/EXIT Programming Mode bar code.
4. Set Length 1 to the first fixed length using the [Aztec Length 1, Length 2 Programming Instructions](#) that follow this page.
5. Set Length 2 to the second fixed length (or to '0000' if there is only one fixed length) using the [Aztec Length 1, Length 2 Programming Instructions](#).

Configuring Variable Length Decoding:

1. Scan the ENTER/EXIT Programming Mode bar code.
2. Scan the Variable Length Decoding bar code.
3. Scan the ENTER/EXIT Programming Mode bar code.
4. Set Length 1 to the minimum length using the [Aztec Length 1, Length 2 Programming Instructions](#) that follow this page.
5. Set Length 2 to the maximum length using the [Aztec Length 1, Length 2 Programming Instructions](#).



★ Aztec Length Control = Variable Length



Aztec Length Control = Fixed Length

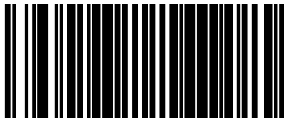

Aztec Length 1, Length 2 Programming Instructions

If Aztec Length Control is set to Fixed-Length decoding, this feature specifies Aztec first fixed length. If Aztec Length Control is set to Variable-Length decoding, this feature specifies the minimum label length.



NOTE: Length 1 is the minimum label length if in variable length mode, or the first fixed length if in fixed length mode. Length 2 is the maximum label length if in variable length mode, or the second fixed length if in fixed length mode. Length includes the barcode's data characters only. Any value > 3700 will be considered to be 3700.

To set this feature:

1. Scan the ENTER/EXIT Programming Mode bar code.
2. Scan the barcode, [Set Aztec Length 1](#) or [Set Aztec Length 2](#) below. You'll need to cover any unused barcodes on this and the facing page to ensure that the scanner reads only the bar code you intend to scan.
3. Scan the appropriate digits from the [Keypad](#) in [Appendix C](#) that represent the desired label length. The selectable range for this option is 0001 to 3700. Pad all numbers with leading zeros to yield a four-digit entry (0001-3700).
4. Complete the programming sequence by scanning the ENTER/EXIT Programming Mode bar code.

Default setting for this feature = 0001



Set Aztec Length 1



Set Aztec Length 2

Default setting for this feature = 3700

APPENDIX A

LED/AUDIO INDICATIONS & CONTROLS

GOOD READ INDICATORS

The base model features two prominent LED indicator bars on top of its vertical “bonnet” and two front-facing LED indicator bars, as shown below.

Figure 1. Scanner and Scale Controls

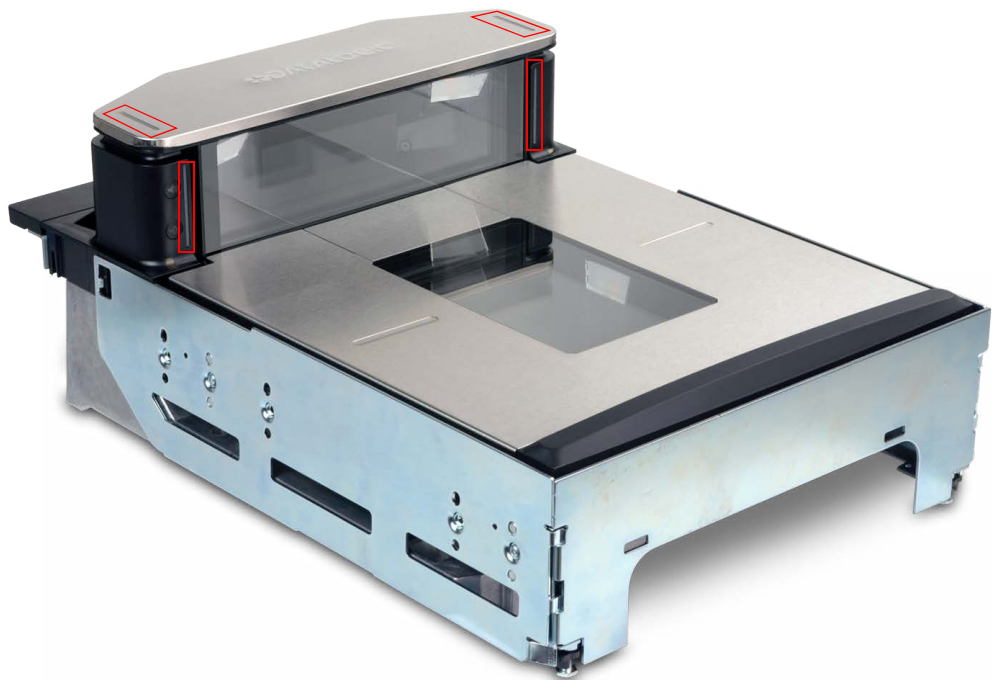

CONTROLS AND INDICATORS

Two panels on either side of the vertical scan windows contain control buttons and more LED indicators. Additionally, a configurable speaker is used to sound scanning, weighing and EAS deactivation indications.

Figure 2. Control Buttons and Indicator LEDs

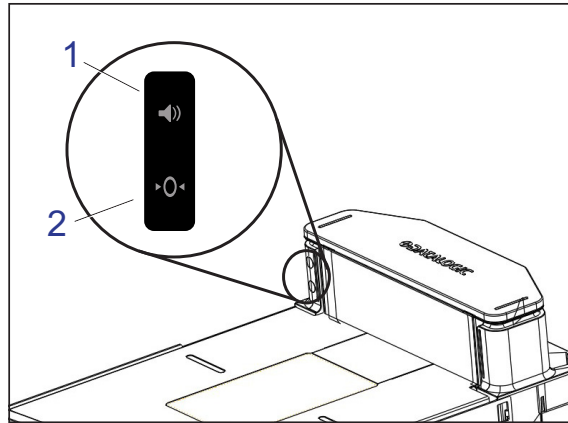

<p>1</p> <p>Speaker icon</p>	<p>Scanner Control Button</p> <ul style="list-style-type: none"> - If the scanner is “asleep”, press this button to wake it up. - Press this button momentarily to enter beeper volume change state. Select one of five volume settings. - Press this button between 1 and 4 seconds to enter beeper tone change state. - Press this button between 5 and 9 seconds to enter Scanner Diagnostics Mode. - Press this button for 10 seconds to initiate a soft reset. 	<p>3</p> <p>Zero icon</p>	<p>Scale Zero Button</p> <p>With all weight removed from the scale, push this button to set the scale to zero.</p>
------------------------------	---	---------------------------	---









LED and Audio Indications



NOTE: Since audio indications are configurable, your unit may not be programmed to sound all the indications as listed. For more information, see the Programming section of this manual.

Scanner and Scale LEDs

The Green Good Read indicator bars (Figure 1) show scanner status, and the Scale LED (Figure 2) is primarily used to show scale status.

LED INDICATION	DURATION	COMMENT
Scale at Zero ^a	Scale (Yellow) LED on steady 	The scale is at rest and reads zero weight. The scale is ready to weigh.
Scanner Active ^a (Normal Mode)	Scanner (Green) LED on steady and dim 	The scanner is ready for operation. Scanning is immediately available.
Good Read Indication ^a	Scanner (Green) LED - bright flash 	Indicates a bar code has been read and decoded.
Program Mode Indication	Scanner (Green) LED - Continuous flashing 	Indicates the scanner is in Label Programming Mode. Cycle power (or read an Exit Programming label) to exit Programming Mode.
Sleep Mode Indication	Scanner (Green) LED flashes slowly 10ms on, 1990ms off. 	The scanner has automatically switched off and the unit has entered Sleep Mode due to extended inactivity.
Scanner Disabled ^a	Scanner (Green) LED blinks 100ms on, 900ms off. 	Host has disabled scanning.
Field Replaceable Unit (FRU) Warning (Error Mode)	Audible low tone 1 second. Alternating Scanner/Scale /EAS and ScaleSentry LEDs flash continuously ^b . 	Serves notice that a fatal FRU failure has been detected. Consult in this manual for more details.
FRU Indication	Scanner (Green) LED flashes a coded sequence in concert with the speaker. 	Occurs ONLY upon Volume/Tone button push following a FRU warning. Enables service technicians to identify FRU failures.
ROM Failure	Scanner (Green) LED - Continuous flashing 200ms on, 200ms off. 	Indicates Boot ROM failure or Program ROM failure.

a. Certain functions of the Green and Yellow LEDs are selectable to be enabled or disabled. Your scanner may not be programmed to display all indications.

b. For FRU error 9, the Deactivator LED (tri-color) is off.

Audio Indications

The speaker (beeper) mounted in the scanner's bonnet will beep or sound other audio indications to announce scanning, weighing, errors or other functions. Beep indications specific to Electronic Article Surveillance (EAS) are listed in the next section.



NOTE: The indications listed below are the factory default settings. Your scanner may have been configured with different beeper settings. For example, certain beeper indications may be turned off.

AUDIO INDICATION	DESCRIPTION OF SOUND	COMMENT
Power-up tone	Unique WAV file sound. Synthesized tones ending with two bell sounds.	Indicates the scanner is powering-on.
Good Read Beep	One beep at current frequency and volume.	The duration of the beep is also at the current setting.
ROM Failure	One 200ms error beep at low frequency.	Indicates Boot ROM or Program ROM failure.
Chirp Indications	Six "Chirps" at highest frequency and current volume.	A "Chirp" is used to indicate the following: -Reading labels while in limited scanning mode. -Label rejection during label programming. -A label with no data. -Labels rejected through the auxiliary port when in Scanner Diagnostics Mode.
Bootload Entry Indications	The beeper sounds a series of beeps at highest frequency and current volume to indicate various	See Error Codes and Problem Isolation for more details.
Null Interface Selected	40 error beeps at highest volume, 20ms ON and 20 ms OFF.	This means that no interface has been selected. Refer to Programming for interface configuration information.
Insert microSD Card	Unique WAV file sound. Similar to a high-pitched plucked string.	This sound occurs upon a microSD Card being installed in the microSD slot. Click the icon in the left column to hear the sound.
Eject microSD Card	Unique WAV file sound. Similar to a medium-pitched plucked string.	Indicates that a microSD Card has been removed from the microSD Card slot. Click the icon in the left column to hear the sound.

Scale Zero Button

The Scale Zero Button (shown in Figure 2) is used for multiple functions as listed below.



NOTE: The Scale Zero Button has no function in a “scanner only” model.

PRESS DURATION	FUNCTION	COMMENT
Momentary	Zero Scale	When programmed to do so, the Scale Indicator LED (see Figure 2) should be lit when no weight is on the scale, indicating scale at zero. If it is not, press the switch to zero the scale. The unit will sound a “click” upon pressing the button.

Calibration Switch

This switch initiates the scale’s calibration routine. A certified weight set is needed to perform the scale calibration steps detailed in [Chapter 5, Calibration Procedures](#). This switch is not included in scanners without scale modules.

Calibration Switch Seal

This seal allows you to secure the Calibration Switch access cover and restrict access to the Calibration Switch. If the calibration seal is broken or missing, you may be prohibited from operating the scale without recertification. Check local and state requirements for specific restrictions.

Calibration Switch Cover

This cover restricts access to the Calibration Switch to help guard against unauthorized tampering when sealed. See Figure 1 on page 69 for more information.

LEGAL NOTE

There are regulations that must be followed in order to ensure compliance when operating a weighing device such as the scanner/scale. Failure to observe and comply with these regulations could result in legal action.



NOTE: This function may not apply to Adaptive Scale models.

APPENDIX B

CABLE INFORMATION

INTRODUCTION

The following pages contain pinout information, enabling you to create standard interface cables for use in interconnecting the scanner, scale, external handheld scanner, and POS terminal.

General Specifications

Wire Requirements

- Cable length should not exceed 15 feet.
- Wire gauge = Standard for RJ-45 connectors (28-26 AWG).
- 26 AWG wire size can improve performance for longer cables.

EXTERNAL CABLE PINOUTS

Connector Hardware RJ45, 10 Position

PIN	RS-232		IBM		EAS COMM PORT
	Scanner	Scale	IBM	IBM USB	Sensormatic Control Box
1	N/C	+5v pullup	N/C	USB D+	N/C
2	CTS in	Clear To Send (input)	N/C	No Connection	N/C
3	N/C	No Connection	N/C	USB D-	N/C
4	RTS out	Request To Send (output)	LINE B	No Connection	N/C
5	RxD in	Receive Data (input)	N/C	No Connection	N/C
6	TxD out	Transmit Data (output)	LINE A	No Connection	N/C
7	ERI	No Connection	N/C	No Connection	EAS_GOOD_RD (red)
8	N/C	No Connection	N/C	No Connection	N/C
9	GND	Signal Ground	GND	Signal Ground	GND (black)
10	N/C	No Connection	N/C	VBUS	N/C

PERIPHERAL PORTS / CONNECTORS

PIN	REMOTE DISPLAY		POWER CABLE
	Hardware: 4 pin SDL		Hardware: 3 pin DIN
1	+12 OUT	+12 OUT	SIGNAL GND
2	LINE_A DSPLY	Line A Display	12V IN
3	LINE_A DSPLY	Line B Display	EARTH
4	GND	Ground	

NOTES

APPENDIX C

KEYPAD

Use the bar codes in this section to enter numbers and characters as you would select digits/characters from a keypad. Scan your selection from the bar codes below. You'll need to cover any unused bar codes on this and the facing page to ensure that the scanner reads only the bar code you intend to scan.



1



3

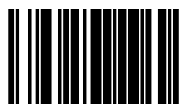

5



0

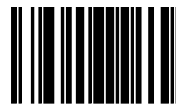

2

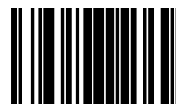

4



6

Use the bar codes in this section to enter numbers and characters as you would select digits/characters from a keypad. Scan your selection from the bar codes below. You'll need to cover any unused bar codes on this and the facing page to ensure that the scanner reads only the bar code you intend to scan.

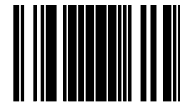

7



8



9

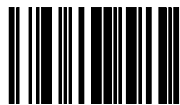

A



B

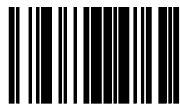

C

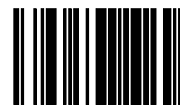

D

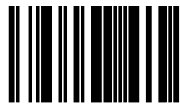

E

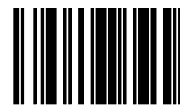

F

APPENDIX D

MICROSD CARD

MICROSDHC COMPATIBILITY

At the time of this writing, the microSD card interface for this product supports SD-Memory Card Specifications/ Part 1. Physical Layer Specification; Version 1.01, but the processor MCI can communicate with SDHC Cards. For example, the scanner can perform the functions specified in this appendix for the SDA 2.0 specification. Both FAT16 and FAT32 formats are supported.

Filenames are limited to the 8.3 file naming format (i.e., FILENAME.EXT), and MUST be capitalized.

MICROSD CARD INSERTION

1. Read all of these instructions before starting.
2. Apply power to the scanner.
3. Lift the rubber cover to access the card slot as shown in Figure 3.

Figure 3. SD Card Location

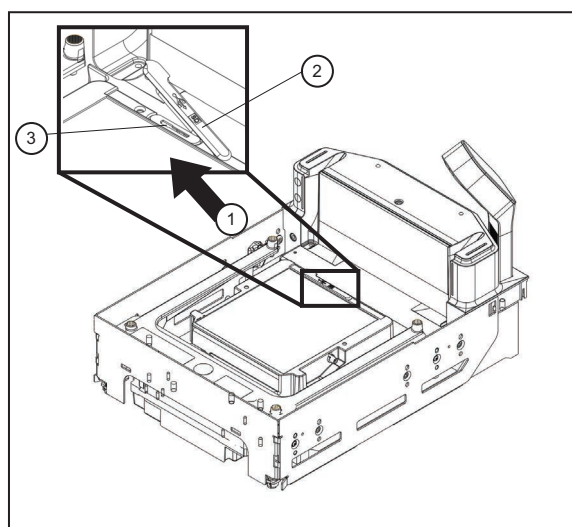

1. microSD Card Slot
2. Rubber Cover
3. microUSB Port

- Carefully insert the microSD card into the slot until it "clicks" into place.



CAUTION: The microSD card slot is spring-loaded. Keep your finger lightly in place atop the card until you are sure it is fully seated in place. See Figure 4

Use your finger or thumbnail to push in on the top edge of the card to be slightly below flush with the scanner enclosure when inserting or removing the card. This will engage/disengage the spring mechanism.

Never insert tools or other foreign objects into the microSD card slot.

Figure 4. Inserting the MicroSD Card

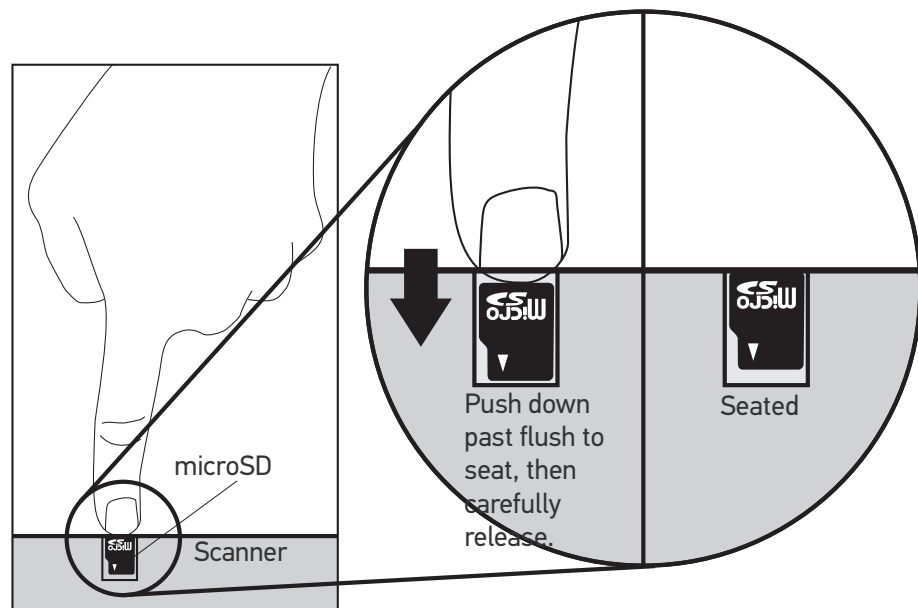

- If installed properly, you should immediately hear an audible signal upon insertion or removal of a microSD card. Various operations will also be indicated by the scanner's good read LED.

microSD Card Removal

Push in gently using your finger or thumbnail to disengage and remove the microSD card. Remember to keep your finger in place atop the card's edge to avoid accidentally "launching" the card from the spring-loaded slot.

AUTORUN FILE PROCESSING

After insertion of the card, the scanner will mount the microSD card and search for the file "AUTORUN.DLS". Embedded in that file is a validation pattern of the ASCII strings "\$START\$" and "\$END\$" located at the respective starting and ending of the file.

If the validation pattern is found, the file may contain any of the following commands. The scanner will parse the file taking action according to these commands. Filenames in italics specify a user-defined name.

Example AUTORUN.DLS file:
 \$START\$ (required)
 CONFIG, *FILENAME.TEX*
 DUMPSTATS, *FILENAME.TXT*
 DUMPCFG, *FILENAME.TEX*
 LOADSW, *FILENAME.BIN*
 \$END\$ (required)

MICROSD FUNCTION SUMMARY

The following table summarizes various functions of microSD card.

FUNCTION		Image Capture	Export Status	Export Configuration	Load Applic	Load Config	Load CPLD Code	Feature Upgrade*
Direction	Scanner ⇒ microSD Card	✓	✓	✓				
	microSD Card ⇒ Scanner				✓	✓	✓	✓
Initiated by	Scanning a label	✓	✓					
	AUTORUN.DLS file in microSD card		✓	✓	✓	✓	✓	✓

* Contact tech support for any available feature upgrade license.

MICROSD FUNCTION DETAILS

From Scanner to MicroSD Card

Capture and save an image to a microSD card by scanning a label.

1. Insert the microSD card into the scanner

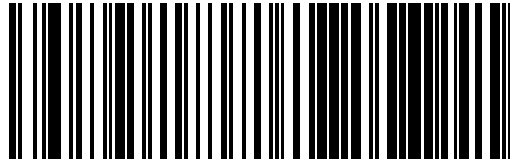

2. Scan the Capture Label. The scanner enters image capture mode.
3. Present the item to be captured to the scanner.
4. Press and release the Camera Button. The scanner will automatically capture and save the image to the microSD card.
5. Upon scanner audio indication of completion, an image is saved to the microSD card.



NOTE: The image file name range is from IMAGE000 to IMAGE999. If the same name already exists in the microSD card, the scanner skips that name and uses the next. For example, if IMAGE000.JPG is already used in the microSD card, the scanner uses IMAGE001.JPG. The time stamp is not real, since scanner does not have a real time clock.

Image format (.BMP, .JPG), image size (VGA, WVGA, Full size), Brightness (0~9), contrast (0~9), and JPG compression ratio (0~100) are defined in configuration.

Export a Configuration file from the Scanner to the microSD card

By AUTORUN.DLS file

1. Generate a text file by any text editor as follows and save it as AUTORUN.DLS.

```
$START$
DUMPCFG,SDCONFIG.TEX (Filename can be anything, for example
"SOMETHING.TEX")
$END$
```
2. Save or copy file AUTORUN.DLS to microSD card.
3. Insert the microSD card to scanner.
4. Wait for 3 seconds. A scanner configuration file named SDCONFIG.TXT is saved to the microSD card.

Export Scanner Status to microSD card

The data includes scanner ID, statistics and scanner health.

By scanning a label

1. Insert the microSD card into the scanner.
2. Scan the status export label.

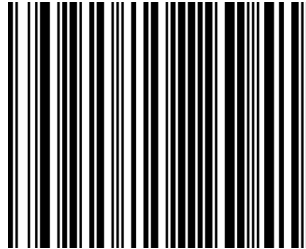

<FNC3>STATUS<CR>

3. Upon scanner audio indication of completion, the scanner status text file named STATUS.TXT is saved to the microSD card.

By AUTORUN.DLS file

1. Generate a text file by any text editor as follows and save it as AUTORUN.DLS.
\$START\$
DUMPSTATS,DMPSTATS.TXT
\$END\$
2. Save or copy the AUTORUN.DLS file to the microSD card
3. Insert the microSD card into the scanner
4. Wait for about 3 seconds. A scanner statistics file named DMPSTATS.TXT is saved to the microSD card.

From MicroSD Card to Scanner

Application code load to scanner

By AUTORUN.DLS file

1. Generate a text file by any text editor as follows and save it as AUTORUN.DLS
\$START\$
LOADSW,R96-APP1.BIN
\$END\$
2. Step 2: Save or copy file AUTORUN.DLS to microSD card and copy the application code (example R96-APP1.BIN) to the microSD card.
3. Insert the microSD card into the scanner.
4. Upon scanner audio indication of completion, the application code R96-APP1.BIN is loaded to the scanner. Typically, this takes about 45 seconds.

Configuration load to scanner

By Autorun file

1. Generate a text file by any text editor as follows and save it as AUTORUN.DLS
\$START\$
CONFIG,R96-CFG1.TEX
\$END\$
2. Save or copy the autorun.dls file, and copy the CPLD code (example R96-CFG1.TEX) to the microSD card
3. Insert the microSD card into to the scanner
4. Upon scanner audio indication of completion, configuration R96-CFG1.TEX is loaded to the scanner.

APPENDIX E

HOST COMMANDS

ACCEPTING COMMANDS FROM AN RS-232 SCANNER HOST

The scanner responds to the following RS-232 commands:

COMMAND	ASCII	HEX	COMMENT
Enable Scanner	E	0x45	
Disable Scanner	D	0x44	
Reset Scanner	R	0x52	
Not On File Indication	F	0x46	Long series of beeps
Beep Good Read Tone	B	0x42	Beeps if Good Read Beep is enabled
Force Good Read Tone		0x01	Beeps regardless of beep setting
Bel		0x07	Force Good Read Tone
Identification request	i	0x69	Returns long response ^a
Health request	h	0x68	Returns long response ^a
Status request	s	0x73	Returns long response ^a

a. Call Tech Support for information.

If one of the above commands is received, the scanner will perform the steps indicated for the command. Host commands for other interfaces is also available. Contact Tech Support for more details.

NOTES

APPENDIX F

FACTORY DEFAULTS

The following table provides a listing of the most common factory settings for the interfaces shown.



NOTE: Some of the individual interfaces listed in the defaults table below appear in the same column since they share similar feature settings with few (if any) exceptions.

Keep in mind though, that the actual configuration storage area for each interface is unique and that updates & changes to factory defaults can be made at any time without notice.

Table 1. Factory Default Settings

Feature	Default Master	RS-232	RS-232 Wincor-Nixdorf	RS-232 Single Cable	Key-board	USB COM / USB-TEC	USB OEM	IBM Port 17 Port 9B Port 5B
IMAGING FEATURES								
TDR Enable	01 (enable)	01 (enable)	01 (enable)	01 (enable)	01 (enable)	01 (enable)	01 (enable)	01 (enable)
Mobile Commerce Reader Enable	01 (enable)	01 (enable)	01 (enable)	01 (enable)	01 (enable)	01 (enable)	01 (enable)	01 (enable)
Mobile Commerce Imagers	00 (Mobile Commerce ONLY)	00 (Mobile Commerce ONLY)	00 (Mobile Commerce ONLY)	00 (Mobile Commerce ONLY)	00 (Mobile Commerce ONLY)	00 (Mobile Commerce ONLY)	00 (Mobile Commerce ONLY)	00 (Mobile Commerce ONLY)
Mobile Commerce Button Function	00 (Toggle)	00 (Toggle)	00 (Toggle)	00 (Toggle)	00 (Toggle)	00 (Toggle)	00 (Toggle)	00 (Toggle)
ECOM Symbology Control	01 (independent control)	01 (independent control)	01 (independent control)	01 (independent control)	01 (independent control)	01 (independent control)	01 (independent control)	01 (independent control)
ECOM Reader Enable UPC-A	01 (enable)	01 (enable)	01 (enable)	01 (enable)	01 (enable)	01 (enable)	01 (enable)	01 (enable)
ECOM Reader Enable UPC-E	01 (enable)	01 (enable)	01 (enable)	01 (enable)	01 (enable)	01 (enable)	01 (enable)	01 (enable)
ECOM Reader Enable EAN-13	01 (enable)	01 (enable)	01 (enable)	01 (enable)	01 (enable)	01 (enable)	01 (enable)	01 (enable)

Feature	Default Master	RS-232	RS-232 Wincor-Nixdorf	RS-232 Single Cable	Key-board	USB COM / USB-TEC	USB OEM	IBM Port 17 Port 9B Port 5B
ECOM Reader Enable EAN-8	01 (enable)	01 (enable)	01 (enable)	01 (enable)	01 (enable)	01 (enable)	01 (enable)	01 (enable)
ECOM Reader Enable Code 93	00 (disable)	00 (disable)	00 (disable)	00 (disable)	00 (disable)	00 (disable)	00 (disable)	00 (disable)
ECOM Reader Enable Codabar	00 (disable)	00 (disable)	00 (disable)	00 (disable)	00 (disable)	00 (disable)	00 (disable)	00 (disable)
ECOM Reader Enable Code 128	01 (enable)	01 (enable)	01 (enable)	01 (enable)	01 (enable)	01 (enable)	01 (enable)	01 (enable)
ECOM Reader Enable Code 39	01 (enable)	01 (enable)	01 (enable)	01 (enable)	01 (enable)	01 (enable)	01 (enable)	01 (enable)
ECOM Reader Enable Interleaved 2 of 5	00 (disable)	00 (disable)	00 (disable)	00 (disable)	00 (disable)	00 (disable)	00 (disable)	00 (disable)
ECOM Reader Enable Datamatrix	00 (disable)	00 (disable)	00 (disable)	00 (disable)	00 (disable)	00 (disable)	00 (disable)	00 (disable)
ECOM Reader Enable Databar Limited	00 (disable)	00 (disable)	00 (disable)	00 (disable)	00 (disable)	00 (disable)	00 (disable)	00 (disable)
ECOM Reader Enable Databar Omnidirectional	00 (disable)	00 (disable)	00 (disable)	00 (disable)	00 (disable)	00 (disable)	00 (disable)	00 (disable)
ECOM Reader Enable Databar Omnidirectional 2D Component	00 (disable)	00 (disable)	00 (disable)	00 (disable)	00 (disable)	00 (disable)	00 (disable)	00 (disable)
ECOM Reader Enable Databar Expanded 2D Component	00 (disable)	00 (disable)	00 (disable)	00 (disable)	00 (disable)	00 (disable)	00 (disable)	00 (disable)
ECOM Reader Enable Databar Expanded	00 (disable)	00 (disable)	00 (disable)	00 (disable)	00 (disable)	00 (disable)	00 (disable)	00 (disable)
ECOM Reader Enable Databar Limited 2D Component	00 (disable)	00 (disable)	00 (disable)	00 (disable)	00 (disable)	00 (disable)	00 (disable)	00 (disable)
ECOM Reader Enable Aztec	00 (disable)	00 (disable)	00 (disable)	00 (disable)	00 (disable)	00 (disable)	00 (disable)	00 (disable)
ECOM Reader Enable EAN-128	00 (disable)	00 (disable)	00 (disable)	00 (disable)	00 (disable)	00 (disable)	00 (disable)	00 (disable)
ECOM Reader Enable Optional P2 Addons	00 (disable)	00 (disable)	00 (disable)	00 (disable)	00 (disable)	00 (disable)	00 (disable)	00 (disable)
ECOM Reader Enable Optional P5 Addons	00 (disable)	00 (disable)	00 (disable)	00 (disable)	00 (disable)	00 (disable)	00 (disable)	00 (disable)
ECOM Reader Enable Micro PDF	00 (disable)	00 (disable)	00 (disable)	00 (disable)	00 (disable)	00 (disable)	00 (disable)	00 (disable)
ECOM Reader Enable Micro QR	00 (disable)	00 (disable)	00 (disable)	00 (disable)	00 (disable)	00 (disable)	00 (disable)	00 (disable)
ECOM Reader Enable MSI	00 (disable)	00 (disable)	00 (disable)	00 (disable)	00 (disable)	00 (disable)	00 (disable)	00 (disable)
ECOM Reader Enable PDF-417	01 (enable)	01 (enable)	01 (enable)	01 (enable)	01 (enable)	01 (enable)	01 (enable)	01 (enable)
ECOM Reader Enable Pharmacode 39	00 (disable)	00 (disable)	00 (disable)	00 (disable)	00 (disable)	00 (disable)	00 (disable)	00 (disable)
ECOM Reader Enable QR URL	00 (disable)	00 (disable)	00 (disable)	00 (disable)	00 (disable)	00 (disable)	00 (disable)	00 (disable)

FACTORY DEFAULTS

Feature	Default Master	RS-232	RS-232 Wincor-Nixdorf	RS-232 Single Cable	Key-board	USB COM / USB-TEC	USB OEM	IBM Port 17 Port 9B Port 5B
ECOM Reader Enable QR Code	01 (enable)	01 (enable)	01 (enable)	01 (enable)	01 (enable)	01 (enable)	01 (enable)	01 (enable)
ECOM Reader Enable Standard 2 of 5	00 (disable)	00 (disable)	00 (disable)	00 (disable)	00 (disable)	00 (disable)	00 (disable)	00 (disable)
Image Capture								
Camera Button Mode	00 (disable)	00 (disable)	00 (disable)	00 (disable)	00 (disable)	00 (disable)	00 (disable)	00 (disable)
Image Camera	02 (TDR)	02 (TDR)	02 (TDR)	02 (TDR)	02 (TDR)	02 (TDR)	02 (TDR)	02 (TDR)
Image Format	00 (JPG)	00 (JPG)	00 (JPG)	00 (JPG)	00 (JPG)	00 (JPG)	00 (JPG)	00 (JPG)
Image Size	00 (VGA)	00 (VGA)	00 (VGA)	00 (VGA)	00 (VGA)	00 (VGA)	00 (VGA)	00 (VGA)
Image Brightness	Level 0	Level 0	Level 0	Level 0	Level 0	Level 0	Level 0	Level 0
Image Contrast	Level 0	Level 0	Level 0	Level 0	Level 0	Level 0	Level 0	Level 0
Image Compression	64 (Compression = 100)	64 (Compression = 100)	64 (Compression = 100)	64 (Compression = 100)	64 (Compression = 100)	64 (Compression = 100)	64 (Compression = 100)	64 (Compression = 100)
Region of Interest (ROI)	000004F F000003 FF (full size)	000004F F000003 FF (full size)	000004F F000003 FF (full size)	000004F F000003 FF (full size)	000004F F000003 FF (full size)	000004F F000003 FF (full size)	000004F F000003 FF (full size)	000004F F000003 FF (full size)
GENERAL SCANNER AND SCALE FEATURES								
1D Double Read Timeout	28 (400ms)	28 (400ms)	28 (400ms)	28 (400ms)	28 (400ms)	28 (400ms)	28 (400ms)	28 (400ms)
2D Double Read Timeout	46 (700ms)	46 (700ms)	46 (700ms)	46 (700ms)	46 (700ms)	46 (700ms)	46 (700ms)	46 (700ms)
Digital Watermark (DWM) Enable	00 (disable)	00 (disable)	00 (disable)	00 (disable)	00 (disable)	00 (disable)	00 (disable)	00 (disable)
Digitally Watermarked (DWM) Double Read Timeout	32 (500 ms)	32 (500 ms)	32 (500 ms)	32 (500 ms)	32 (500 ms)	32 (500 ms)	32 (500 ms)	32 (500 ms)
Digital Watermark (DWM) Operation Mode	00 (dedicated)	00 (dedicated)	00 (dedicated)	00 (dedicated)	00 (dedicated)	00 (dedicated)	00 (dedicated)	00 (dedicated)
Digital Watermark (DWM) Data Format	00 (compatibility mode)	00 (compatibility mode)	00 (compatibility mode)	00 (compatibility mode)	00 (compatibility mode)	00 (compatibility mode)	00 (compatibility mode)	00 (compatibility mode)
Digital Watermark (DWM) 2D Time	28 (40 ms)	28 (40 ms)	28 (40 ms)	28 (40 ms)	28 (40 ms)	28 (40 ms)	28 (40 ms)	28 (40 ms)
Label Gone Timeout	10 (16 cycles)	10 (16 cycles)	10 (16 cycles)	10 (16 cycles)	10 (16 cycles)	10 (16 cycles)	10 (16 cycles)	10 (16 cycles)
Sleep Mode Timer	5 minutes	5 minutes	5 minutes	5 minutes	5 minutes	5 minutes	5 minutes	5 minutes
1D Inverse Read Control	00 (disable)	00 (disable)	00 (disable)	00 (disable)	00 (disable)	00 (disable)	00 (disable)	00 (disable)
2D Inverse Read Control	00 (disable)	00 (disable)	00 (disable)	00 (disable)	00 (disable)	00 (disable)	00 (disable)	00 (disable)
Illumination Control	00 (disable)	00 (disable)	00 (disable)	00 (disable)	00 (disable)	00 (disable)	00 (disable)	00 (disable)

Feature	Default Master	RS-232	RS-232 Wincor-Nixdorf	RS-232 Single Cable	Key-board	USB COM / USB-TEC	USB OEM	IBM Port 17 Port 9B Port 5B
2D Contrast Improvement	00 (disable)	00 (disable)	00 (disable)	00 (disable)	00 (disable)	00 (disable)	00 (disable)	00 (disable)
1D VL Shared Decode Timeout	0F (15 ms)	0F (15 ms)	0F (15 ms)	0F (15 ms)	0F (15 ms)	0F (15 ms)	0F (15 ms)	0F (15 ms)
Good Read LED Idle State	02 (on dim)	02 (on dim)	02 (on dim)	02 (on dim)	02 (on dim)	02 (on dim)	02 (on dim)	02 (on dim)
Scanner Control Button Options	00 (enable all)	00 (enable all)	00 (enable all)	00 (enable all)	00 (enable all)	00 (enable all)	00 (enable all)	00 (enable all)
Power-up Tone Control	01 (1 beep)	01 (1 beep)	01 (1 beep)	01 (1 beep)	01 (1 beep)	01 (1 beep)	01 (1 beep)	01 (1 beep)
Good Read Beep Control	01 (enable)	01 (enable)	01 (enable)	01 (enable)	01 (enable)	01 (enable)	01 (enable)	01 (enable)
Good Read Beep Frequency	01 (med.)	01 (med.)	01 (med.)	01 (med.)	01 (med.)	01 (med.)	01 (med.)	01 (med.)
Good Read Beep Length	008 (80ms)	008 (80ms)	008 (80ms)	008 (80ms)	008 (80ms)	008 (80ms)	008 (80ms)	008 (80ms)
Good Read Beep Volume	04 (high)	04 (high)	04 (high)	04 (high)	04 (high)	04 (high)	04 (high)	04 (high)
Good Read When to Indicate	00 (after decode)	00 (after decode)	00 (after decode)	00 (after decode)	00 (after decode)	00 (after decode)	00 (after decode)	00 (after decode)
Scale Zero Button and Scale Indicator LED	03 (zero button & LED disconnected)	03 (zero button & LED disconnected)	03 (zero button & LED disconnected)	03 (zero button & LED disconnected)		03 (zero button & LED disconnected)	03 (zero button & LED disconnected)	03 (zero button & LED disconnected)
Scale Sentry	01 (enable)	01 (enable)	01 (enable)	01 (enable)		01 (enable)	01 (enable)	01 (enable)
Scale Sentry Block Weight Transmission	01 (enable)	01 (enable)	01 (enable)	01 (enable)	01 (enable)	01 (enable)	01 (enable)	01 (enable)
Scale Sentry Override Button	01 (enable)	01 (enable)	01 (enable)	01 (enable)	01 (enable)	01 (enable)	01 (enable)	01 (enable)
Scale Sentry Mode	01 (weight integration)	01 (weight integration)	01 (weight integration)	01 (weight integration)	01 (weight integration)	01 (weight integration)	01 (weight integration)	01 (weight integration)
Scale Sentry GRI Enable	01 (enable)	01 (enable)	01 (enable)	01 (enable)	01 (enable)	01 (enable)	01 (enable)	01 (enable)
Scale Sentry Adaptive Scale Indication State	01 (Active High)	01 (Active High)	01 (Active High)	01 (Active High)	01 (Active High)	01 (Active High)	01 (Active High)	01 (Active High)
Adaptive Scale LED Option	00 (Zero LED)	00 (Zero LED)	00 (Zero LED)	00 (Zero LED)	00 (Zero LED)	00 (Zero LED)	00 (Zero LED)	00 (Zero LED)
Scale Enable	01 (enable)	01 (enable)	01 (enable)	01 (enable)		01 (enable)	01 (enable)	01 (enable)
Scale Diagnostics Mode	01 (enable)	01 (enable)	01 (enable)	01 (enable)		01 (enable)	01 (enable)	01 (enable)
Scale Stale Weight Timeout	330ms			330ms				

FACTORY DEFAULTS

Feature	Default Master	RS-232	RS-232 Wincor-Nixdorf	RS-232 Single Cable	Key-board	USB COM / USB-TEC	USB OEM	IBM Port 17 Port 9B Port 5B
Scale Enforced Zero Return	03 (non-zero for 4 min.)	03 (non-zero for 4 min.)	03 (non-zero for 4 min.)	00 (dis-able)		03 (non-zero for 4 min.)	03 (non-zero for 4 min.)	03 (non-zero for 4 min.)
Scale Interface Type	04 (RS-232 SASI)	04 (RS-232 SASI)	04 (RS-232 SASI)			04 (RS-232 SASI)	04 (RS-232 SASI)	
Scale Baud Rate	00 (dis-able)	00 (dis-able)	00 (dis-able)					
Scale Interface Set-tings	00 (dis-able)	00 (dis-able)	00 (dis-able)					
Scale Interface Options	00 (dis-able)	00 (dis-able)	00 (dis-able)					
ICL Scale Interface DC1 Character Delay	00 (dis-able)	00 (dis-able)	00 (dis-able)	00 (dis-able)	00 (dis-able)	00 (dis-able)	00 (dis-able)	00 (dis-able)
Team POS ICL Scale Mode Enable	00 (dis-able)	00 (dis-able)	00 (dis-able)	00 (dis-able)	00 (dis-able)	00 (dis-able)	00 (dis-able)	00 (dis-able)
Scale Calibration Noti-fication	00 (dis-able)	00 (dis-able)	00 (dis-able)	00 (dis-able)		00 (dis-able)	00 (dis-able)	00 (dis-able)
Scale Intercharacter Delay	00 (no delay)	00 (no delay)	00 (no delay)			00 (no delay)		
Remote Display — Enable/Disable	01 (enable)	01 (enable)	01 (enable)	01 (enable)		01 (enable)	01 (enable)	01 (enable)
Auxiliary USB Mode	00 (dis-able)	00 (dis-able)	01 (external HH input)	00 (dis-able)	00 (dis-able)	00 (dis-able)	00 (dis-able)	00 (dis-able)
Auxiliary USB Mode	00 (dis-able)	00 (dis-able)	00 (dis-able)	00 (dis-able)	00 (dis-able)	00 (dis-able)	00 (dis-able)	00 (dis-able)
USB Device Port Loca-tion	00 (top-side)	00 (top-side)	00 (top-side)	00 (top-side)	00 (top-side)	00 (top-side)	00 (top-side)	00 (top-side)
PIR / CT	00 (dis-able)	00 (dis-able)	00 (dis-able)	00 (dis-able)	00 (dis-able)	00 (dis-able)	00 (dis-able)	00 (dis-able)
EAS FEATURES								
EAS Mode	00 (dis-able)	00 (dis-able)	00 (dis-able)	00 (dis-able)	00 (dis-able)	00 (dis-able)	00 (dis-able)	00 (dis-able)
EAS Notification	00 (dis-able)	00 (dis-able)	00 (dis-able)	00 (dis-able)	00 (dis-able)	00 (dis-able)	00 (dis-able)	00 (dis-able)
EAS Security Level	01 (med.)	01 (med.)	01 (med.)	01 (med.)	01 (med.)	01 (med.)	01 (med.)	01 (med.)
EAS Good Beep Mode	00 (dis-able)	00 (dis-able)	00 (dis-able)	00 (dis-able)	00 (dis-able)	00 (dis-able)	00 (dis-able)	00 (dis-able)
EAS Beep Duration	008 (80ms)	008 (80ms)	008 (80ms)	008 (80ms)	008 (80ms)	008 (80ms)	008 (80ms)	008 (80ms)
EAS Retry Count	03 (retry 3 times)	03 (retry 3 times)	03 (retry 3 times)	03 (retry 3 times)	03 (retry 3 times)	03 (retry 3 times)	03 (retry 3 times)	03 (retry 3 times)
EAS Exception Button	02 (enable only when scanner enabled)	02 (enable only when scanner enabled)	02 (enable only when scanner enabled)	02 (enable only when scanner enabled)	02 (enable only when scanner enabled)	02 (enable only when scanner enabled)	02 (enable only when scanner enabled)	02 (enable only when scanner enabled)
EAS Deactivation Duration — Coupled	040 (400ms)	040 (400ms)	040 (400ms)	040 (400ms)	040 (400ms)	040 (400ms)	040 (400ms)	040 (400ms)

Feature	Default Master	RS-232	RS-232 Wincor-Nixdorf	RS-232 Single Cable	Key-board	USB COM / USB-TEC	USB OEM	IBM Port 17 Port 9B Port 5B
EAS Deactivation Duration — Retry	050 (500ms)	050 (500ms)	050 (500ms)	050 (500ms)	050 (500ms)	050 (500ms)	050 (500ms)	050 (500ms)
EAS Deactivation Duration — Exception	100 (1 sec.)	100 (1 sec.)	100 (1 sec.)	100 (1 sec.)	100 (1 sec.)	100 (1 sec.)	100 (1 sec.)	100 (1 sec.)
EAS Pre-Read Time	025 (250ms)	025 (250ms)	025 (250ms)	025 (250ms)	025 (250ms)	025 (250ms)	025 (250ms)	025 (250ms)
ERI Active State	00 (low)	00 (low)	00 (low)	00 (low)	00 (low)	00 (low)	00 (low)	00 (low)
ERI Timeout	02 (20ms)	02 (20ms)	02 (20ms)	02 (20ms)	02 (20ms)	02 (20ms)	02 (20ms)	02 (20ms)
INTERFACE RELATED FEATURES								
Maximum Host-Transmitted Message Length	000 (no gen. limit imposed)	000 (no gen. limit imposed)	000 (no gen. limit imposed)	000 (no gen. limit imposed)	000 (no gen. limit imposed)	000 (no gen. limit imposed)	000 (no gen. limit imposed)	000 (no gen. limit imposed)
IBM Interface Options	00	00	00	10	00	00	00	00
IBM Scale Address	6E						6E	6E
IBM Transmit Labels in Code 39 Format	00 (dis-able)						00 (dis-able)	00 (dis-able)
46XX Number of Host Resets	06						06	06
46XX Label Slicing Control	01 (multi pieces)						01 (multi pieces)	01 (multi pieces)
46XX Maximum Label Slice Length	064 (64 characters)						064 (64 characters)	064 (64 characters)
USB OEM Interface Options	02	02	02	02	02	02	01	02
USB OEM Additional Interface Options	00 (dis-abled upon enumeration)						00 (dis-abled upon enumeration)	
USB OEM Scanner Device Type	00 (table top)						00 (table top)	00 (table top)
RS-232 Baud Rate	01 (9600)	01 (9600)	01 (9600)	01 (9600)		01 (9600)		
RS-232 Number of Data Bits	01 (8 data bits)	01 (8 data bits)	01 (8 data bits)	00 (7 data bits)		01 (8 data bits)		
RS-232 Number of Stop Bits	00 (1 stop bit)	00 (1 stop bit)	00 (1 stop bit)	00 (1 stop bit)		00 (1 stop bit)		
RS-232 Parity	00 (none)	00 (none)	02 (odd)	02 (odd)		00 (none)		
RS-232 Hardware Control	00 (dis-able)	00 (dis-able)	01 (enable CTS flow control)			00 (dis-able)		
RS-232 Intercharacter Delay	00 (no delay)	00 (no delay)	00 (no delay)			00 (no delay)		
RS-232 Software Flow Control	00 (dis-able)	00 (dis-able)	00 (dis-able)	00 (dis-able)		00 (dis-able)		
RS-232 Ignore Host Commands	01 (ignore)	01 (ignore)	01 (ignore)	01 (ignore)	01 (ignore)	01 (ignore)	01 (ignore)	01 (ignore)

FACTORY DEFAULTS

Feature	Default Master	RS-232	RS-232 Wincor-Nixdorf	RS-232 Single Cable	Key-board	USB COM / USB-TEC	USB OEM	IBM Port 17 Port 9B Port 5B
RS-232 TTL	00 (normal)	00 (normal)	00 (normal)			00 (normal)		
RS-232 TTL Invert	00 (disable)	00 (disable)	00 (disable)			00 (disable)		
RS-232 Beep on ASCII BEL	00 (disable)	00 (disable)	00 (disable)			00 (disable)		
RS-232 Beep After Weigh	00 (disable)	00 (disable)	00 (disable)	00 (disable)		00 (disable)		
Beep on Not on File	01 (low vol)	01 (low vol)	01 (low vol)	01 (low vol)		01 (low vol)	01 (low vol)	01 (low vol)
RS-232 ACK NAK Enable	00 (disable)	00 (disable)	00 (disable)			00 (disable)		
RS-232 ACK Character	06 (ACK)	06 (ACK)	06 (ACK)			06 (ACK)		
RS-232 NAK Character	15 (NAK)	15 (NAK)	15 (NAK)			15 (NAK)		
RS-232 Retry on ACK NAK Timeout	01 (enable)	01 (enable)	01 (enable)			01 (enable)		
RS-232 ACK NAK Timeout Value	01 (200ms)	01 (200ms)	01 (200ms)			01 (200ms)		
RS-232 ACK NAK Retry Count	03 (3 retries)	03 (3 retries)	03 (3 retries)			03 (3 retries)		
RS-232 ACK NAK Error Handling	00 (ignore)	00 (ignore)	00 (ignore)			00 (ignore)		
RS-232 Indicate Transmission Failure	01 (enable)	01 (enable)	01 (enable)			01 (enable)		
Single Cable RS-232 Scanner Only Protocol	00 (scanner/scale RS-232)			00 (scanner/scale RS-232)				
Single Cable RS-232 RTS CTS Selection	05 (RTS high, wait for CTS)			05 (RTS high, wait for CTS)				
Single Cable RS-232 Use BCC	00 (disable)			00 (disable)				
Single Cable RS-232 Use ACK/NAK	00 (disable)			00 (disable)				
Single Cable RS-232 Use STX	01 (enable)			01 (enable)				
Set Single Cable RS-232 STX Character	053 (S)			053 (S)				
Single Cable RS-232 Use ETX	01 (enable)			01 (enable)				
Set Single Cable RS-232 ETX Character	00D (CR)			00D (CR)				
Single Cable RS-232 Datalogic Extensions	00 (std. protocol)			00 (std. protocol)				
Single Cable RS-232 Pacesetter Plus	00 (do not send)			00 (do not send)				
USB Keyboard and Keyboard Wedge Intercharacter Delay	01 (10ms)				01 (10ms)			

Feature	Default Master	RS-232	RS-232 Wincor-Nixdorf	RS-232 Single Cable	Key-board	USB COM / USB-TEC	USB OEM	IBM Port 17 Port 9B Port 5B
Keyboard Wedge No Keyboard Support	00 (dis-able)				00 (dis-able)			
USB Keyboard and Keyboard Wedge Send Control Characters	00 (dis-able)				00 (dis-able)			
USB Keyboard and Keyboard Wedge Country Mode	00 (USA)				00 (USA)			
Keyboard Wedge Quiet Interval	0A (100ms)				0A (100ms)			
USB Keyboard and Keyboard Wedge Caps Lock State	00 (caps lock OFF)				00 (caps lock OFF)			
DATA EDITING								
Case Conversion	00 (no case convers'n)	00 (no case convers'n)	00 (no case convers'n)	00 (no case convers'n)	00 (no case convers'n)	00 (no case convers'n)	00 (no case convers'n)	00 (no case convers'n)
Character Conversion	FFFFFF FFFFFFFF FF (no char. convers'n)	FFFFFF FFFFFFFF FF (no char. convers'n)	FFFFFF FFFFFFFF FF (no char. convers'n)	FFFFFF FFFFFFFF FF (no char. convers'n)	FFFFFF FFFFFFFF FF (no char. convers'n)	FFFFFF FFFFFFFF FF (no char. convers'n)	FFFFFF FFFFFFFF FF (no char. convers'n)	FFFFFF FFFFFFFF FF (no char. convers'n)
Global Prefix	00 (no prefix)	00 (no prefix)	00 (no prefix)	00 (no prefix)	00 (no prefix)	00 (no prefix)	00 (no prefix)	00 (no prefix)
Global Suffix	0D00 (CR)	0D00 (CR)	0D00 (CR)	0000 (CR)	0D00 (CR)	0D00 (CR)	0D00 (CR)	0D00 (CR)
Global AIM ID Enable	00 (dis-able)	00 (dis-able)	00 (dis-able)	00 (dis-able)	00 (dis-able)	00 (dis-able)		
Label ID Control	01 (Enable as prefix)	01 (Enable as prefix)	01 (Enable as prefix)	01 (Enable as prefix)	01 (Enable as prefix)	01 (Enable as prefix)		
Global Mid-Label ID	00 (no mid-label ID)	00 (no mid-label ID)	00 (no mid-label ID)	00 (no mid-label ID)	00 (no mid-label ID)	00 (no mid-label ID)		
1D SYMBOLGY PROGRAMMING								
Coupon Control	01 (enable UPC-A)	01 (enable UPC-A)	01 (enable UPC-A)	01 (enable UPC-A)	01 (enable UPC-A)	01 (enable UPC-A)	01 (enable UPC-A)	01 (enable UPC-A)
Coupon Label Priority Timer	14 (200 ms)	14 (200 ms)	14 (200 ms)	14 (200 ms)	14 (200 ms)	14 (200 ms)	14 (200 ms)	14 (200 ms)
UPC-A Enable	01 (enable)	01 (enable)	01 (enable)	01 (enable)	01 (enable)	01 (enable)	01 (enable)	01 (enable)
UPC-A Number System Character Transmission	01 (enable)	01 (enable)	01 (enable)	01 (enable)	01 (enable)	01 (enable)	01 (enable)	01 (enable)
UPC-A Check Character Transmission	01 (enable)	01 (enable)	01 (enable)	00 (dis-able)	01 (enable)	01 (enable)	01 (enable)	01 (enable)
UPC-A Minimum Read	01 (1 read)	01 (1 read)	01 (1 read)	01 (1 read)	01 (1 read)	01 (1 read)	01 (1 read)	01 (1 read)

FACTORY DEFAULTS

Feature	Default Master	RS-232	RS-232 Wincor-Nixdorf	RS-232 Single Cable	Key-board	USB COM / USB-TEC	USB OEM	IBM Port 17 Port 9B Port 5B
Expand UPC-A to EAN-13	00 (disable)	00 (disable)	01 (enable)	00 (disable)	00 (disable)	00 (disable)	00 (disable)	00 (disable)
UPC-E Enable	01 (enable)	01 (enable)	01 (enable)	01 (enable)	01 (enable)	01 (enable)	01 (enable)	01 (enable)
UPC-E Number System Character Transmission	01 (enable)	01 (enable)	01 (enable)	01 (enable)	01 (enable)	01 (enable)	01 (enable)	01 (enable)
UPC-E Check Character Transmission	01 (enable)	01 (enable)	00 (disable)	01 (enable)	01 (enable)	01 (enable)	01 (enable)	01 (enable)
Expand UPC-E to UPC-A	00 (disable)	00 (disable)	00 (disable)	00 (disable)	00 (disable)	00 (disable)	00 (disable)	00 (disable)
Expand UPC-E to EAN-13	00 (disable)	00 (disable)	00 (disable)	00 (disable)	00 (disable)	00 (disable)	00 (disable)	00 (disable)
UPC-E Minimum Read	01 (1 read)	01 (1 read)	01 (1 read)	01 (1 read)	01 (1 read)	01 (1 read)	01 (1 read)	01 (1 read)
EAN-13 Enable	01 (enable)	01 (enable)	01 (enable)	01 (enable)	01 (enable)	01 (enable)	01 (enable)	01 (enable)
EAN-13 First Character Transmission	01 (enable)	01 (enable)	01 (enable)	01 (enable)	01 (enable)	01 (enable)	01 (enable)	01 (enable)
EAN-13 Check Character Transmission	01 (enable)	01 (enable)	01 (enable)	00 (disable)	01 (enable)	01 (enable)	01 (enable)	01 (enable)
EAN-13 ISBN Conversion Enable	00 (disable)	00 (disable)	00 (disable)	00 (disable)	00 (disable)	00 (disable)	00 (disable)	00 (disable)
EAN-13 Minimum Read	01 (1 read)	01 (1 read)	01 (1 read)	01 (1 read)	01 (1 read)	01 (1 read)	01 (1 read)	01 (1 read)
EAN-8	01 (enable)	01 (enable)	01 (enable)	01 (enable)	01 (enable)	01 (enable)	01 (enable)	01 (enable)
EAN-8 Check Character Transmission	01 (enable)	01 (enable)	01 (enable)	00 (disable)	01 (enable)	01 (enable)	01 (enable)	01 (enable)
Expand EAN-8 to EAN-13	00 (disable)	00 (disable)	00 (disable)	00 (disable)	00 (disable)	00 (disable)	00 (disable)	00 (disable)
EAN-8 Minimum Read	01 (1 read)	01 (1 read)	01 (1 read)	01 (1 read)	01 (1 read)	01 (1 read)	01 (1 read)	01 (1 read)
EAN-8 Minimum Segment Length	08 (8 characters)	08 (8 characters)	08 (8 characters)	08 (8 characters)	08 (8 characters)	08 (8 characters)	08 (8 characters)	08 (8 characters)
EAN-8 Guard Insertion	00 (disable)	00 (disable)	00 (disable)	00 (disable)	00 (disable)	00 (disable)	00 (disable)	00 (disable)
EAN-8 Guard Substitution	00 (disable)	00 (disable)	00 (disable)	00 (disable)	00 (disable)	00 (disable)	00 (disable)	00 (disable)
EAN-8/Jan-8 Both Guards Substitution	00 (disable)	00 (disable)	00 (disable)	00 (disable)	00 (disable)	00 (disable)	00 (disable)	00 (disable)
EAN-8 Stitch Exact Label Halves	00 (disable)	00 (disable)	00 (disable)	00 (disable)	00 (disable)	00 (disable)	00 (disable)	00 (disable)
EAN-8 Stitch Unlike Label Halves	00 (disable)	00 (disable)	00 (disable)	00 (disable)	00 (disable)	00 (disable)	00 (disable)	00 (disable)
EAN-8 Decoding Levels	01 (Very Conservative)	01 (Very Conservative)	01 (Very Conservative)	01 (Very Conservative)	01 (Very Conservative)	01 (Very Conservative)	01 (Very Conservative)	01 (Very Conservative)

Feature	Default Master	RS-232	RS-232 Wincor-Nixdorf	RS-232 Single Cable	Key-board	USB COM / USB-TEC	USB OEM	IBM Port 17 Port 9B Port 5B
In-Store Printed Label Minimum Read	01 (1 read)	01 (1 read)	01 (1 read)	01 (1 read)	01 (1 read)	01 (1 read)	01 (1 read)	01 (1 read)
UPC/EAN Reconstruction	00 (disable)	00 (disable)	00 (disable)	00 (disable)	00 (disable)	00 (disable)		
UPC/EAN Correlation	00 (disable)	00 (disable)	00 (disable)	00 (disable)	00 (disable)	00 (disable)	00 (disable)	00 (disable)
UPC/EAN Guard Insertion	00 (disable)	00 (disable)	00 (disable)	00 (disable)	00 (disable)	00 (disable)	00 (disable)	00 (disable)
UPC/EAN Stitch Exact Label Halves	00 (disable)	00 (disable)	00 (disable)	00 (disable)	00 (disable)	00 (disable)	00 (disable)	00 (disable)
UPC/EAN Stitch Unlike Label Halves	00 (disable)	00 (disable)	00 (disable)	00 (disable)	00 (disable)	00 (disable)	00 (disable)	00 (disable)
UPC/EAN Minimum Segment Length	05 (5 char.)	05 (5 char.)	05 (5 char.)	05 (5 char.)	05 (5 char.)	05 (5 char.)	05 (5 char.)	05 (5 char.)
Price Weight Check	00 (disable)	00 (disable)	00 (disable)	00 (disable)	00 (disable)	00 (disable)	00 (disable)	00 (disable)
Enable EAN Two Label	00 (disable)	00 (disable)	00 (disable)	00 (disable)	00 (disable)	00 (disable)	00 (disable)	00 (disable)
EAN Two Label Minimum Read	01 (1 read)	01 (1 read)	01 (1 read)	01 (1 read)	01 (1 read)	01 (1 read)	01 (1 read)	01 (1 read)
EAN Two Label Combined Transmission	00 (disable)	00 (disable)	00 (disable)	00 (disable)	00 (disable)	00 (disable)	00 (disable)	00 (disable)
Addons	disable all	disable all	disable all	disable all	disable all	disable all	disable all	disable all
P2 Addon Minimum Read	02 (2 reads)	02 (2 reads)	02 (2 reads)	02 (2 reads)	02 (2 reads)	02 (2 reads)	02 (2 reads)	02 (2 reads)
P5 Addon Minimum Read	01 (1 read)	01 (1 read)	01 (1 read)	01 (1 read)	01 (1 read)	01 (1 read)	01 (1 read)	01 (1 read)
GTIN Enable	00 (disable)	00 (disable)	00 (disable)	00 (disable)	00 (disable)	00 (disable)		
DataBar Omnidirectional Enable	00 (disable)	00 (disable)	00 (disable)	00 (disable)	00 (disable)	00 (disable)	00 (disable)	00 (disable)
DataBar Omnidirectional/EAN-128 Emulation	00 (disable)	00 (disable)	00 (disable)	00 (disable)	00 (disable)	00 (disable)	00 (disable)	00 (disable)
DataBar Omnidirectional 2D Component Enable	00 (disable)	00 (disable)	00 (disable)	00 (disable)	00 (disable)	00 (disable)	00 (disable)	00 (disable)
DataBar Omnidirectional Minimum Read	01 (1 read)	01 (1 read)	01 (1 read)	01 (1 read)	01 (1 read)	01 (1 read)	01 (1 read)	01 (1 read)
DataBar Omnidirectional Double Read Timeout	32 (2.5 seconds)	32 (2.5 seconds)	32 (2.5 seconds)	32 (2.5 seconds)	32 (2.5 seconds)	32 (2.5 seconds)	32 (2.5 seconds)	32 (2.5 seconds)
DataBar Expanded Enable	00 (disable)	00 (disable)	00 (disable)	00 (disable)	00 (disable)	00 (disable)	00 (disable)	00 (disable)
DataBar Expanded EAN-128 Emulation	00 (disable)	00 (disable)	00 (disable)	00 (disable)	00 (disable)	00 (disable)	00 (disable)	00 (disable)
DataBar Expanded 2D Component Enable	00 (disable)	00 (disable)	00 (disable)	00 (disable)	00 (disable)	00 (disable)	00 (disable)	00 (disable)

FACTORY DEFAULTS

Feature	Default Master	RS-232	RS-232 Wincor-Nixdorf	RS-232 Single Cable	Key-board	USB COM / USB-TEC	USB OEM	IBM Port 17 Port 9B Port 5B
DataBar Expanded Minimum Read	01 (1 read)	01 (1 read)	01 (1 read)	01 (1 read)	01 (1 read)	01 (1 read)	01 (1 read)	01 (1 read)
DataBar Expanded Length Control	00 (variable)	00 (variable)	00 (variable)	00 (variable)	00 (variable)	00 (variable)	00 (variable)	00 (variable)
DataBar Expanded Length 1	01	01	01	01	01	01	01	01
DataBar Expanded Length 2	74	74	74	74	74	74	74	74
DataBar Expanded Reverse Retry Enable	00 (disable)	00 (disable)	00 (disable)	00 (disable)	00 (disable)	00 (disable)	00 (disable)	00 (disable)
DataBar Limited Enable	00 (disable)	00 (disable)	00 (disable)	00 (disable)	00 (disable)	00 (disable)	00 (disable)	00 (disable)
DataBar Limited Minimum Read	01 (1 read)	01 (1 read)	01 (1 read)	01 (1 read)	01 (1 read)	01 (1 read)	01 (1 read)	01 (1 read)
DataBar Limited 2D Component Enable	00 (disable)	00 (disable)	00 (disable)	00 (disable)	00 (disable)	00 (disable)	00 (disable)	00 (disable)
DataBar Limited EAN128 Emulation Enable	00 (disable)	00 (disable)	00 (disable)	00 (disable)	00 (disable)	00 (disable)	00 (disable)	00 (disable)
Code 39 Enable	01 (enable)	01 (enable)	00 (disable)	01 (enable)	01 (enable)	01 (enable)	01 (enable)	01 (enable)
Code 39 Start Stop Character Transmission	00 (disable)	00 (disable)	00 (disable)	00 (disable)	00 (disable)	00 (disable)	00 (disable)	00 (disable)
Code 39 Check Character Calculation	00 (disable)	00 (disable)	00 (disable)	00 (disable)	00 (disable)	00 (disable)	00 (disable)	00 (disable)
Code 39 Check Character Transmission	01 (enable)	01 (enable)	01 (enable)	01 (enable)	01 (enable)	01 (enable)	01 (enable)	01 (enable)
Code 39 Full ASCII	00 (disable)	00 (disable)	00 (disable)	00 (disable)	00 (disable)	00 (disable)	00 (disable)	00 (disable)
Code 39 Minimum Read	01 (1 read)	01 (1 read)	01 (1 read)	01 (1 read)	01 (1 read)	01 (1 read)	01 (1 read)	01 (1 read)
Code 39 Correlation	00 (disable)	00 (disable)	00 (disable)	00 (disable)	00 (disable)	00 (disable)	00 (disable)	00 (disable)
Code 39 Length Control	00 (variable)	00 (variable)	00 (variable)	00 (variable)	00 (variable)	00 (variable)	00 (variable)	00 (variable)
Code 39 Length 1	02	02	02	02	02	02	02	02
Code 39 Length 2	50	50	50	50	50	50	50	50
Code 39 Stitching	01 (enable)	01 (enable)	01 (enable)	01 (enable)	01 (enable)	01 (enable)	01 (enable)	01 (enable)
Code 39 Require Margins	00 (disable)	00 (disable)	00 (disable)	00 (disable)	00 (disable)	00 (disable)	00 (disable)	00 (disable)
Code 32 Italian Pharmacode Enable	00 (disable)	00 (disable)	00 (disable)	00 (disable)	00 (disable)	00 (disable)	00 (disable)	00 (disable)
Code 32 Start Stop Character Transmission	00 (disable)	00 (disable)	00 (disable)	00 (disable)	00 (disable)	00 (disable)	00 (disable)	00 (disable)
Code 32 Check Character Transmission	00 (disable)	00 (disable)	00 (disable)	00 (disable)	00 (disable)	00 (disable)		00 (disable)

Feature	Default Master	RS-232	RS-232 Wincor-Nixdorf	RS-232 Single Cable	Key-board	USB COM / USB-TEC	USB OEM	IBM Port 17 Port 9B Port 5B
Code 128 Enable	01 (enable)	01 (enable)	01 (enable)	01 (enable)	01 (enable)	01 (enable)	01 (enable)	01 (enable)
Code 128 Transmit Function Characters	00 (disable)	00 (disable)	00 (disable)	00 (disable)	00 (disable)	00 (disable)	00 (disable)	00 (disable)
Expand Code 128 to Code 39	00 (disable)	00 (disable)	00 (disable)	00 (disable)	00 (disable)	00 (disable)	00 (disable)	00 (disable)
Code 128 Minimum Read	01 (1 read)	01 (1 read)	01 (1 read)	01 (1 read)	01 (1 read)	01 (1 read)	01 (1 read)	01 (1 read)
Code 128 Correlation	00 (disable)	00 (disable)	00 (disable)	00 (disable)	00 (disable)	00 (disable)	00 (disable)	00 (disable)
Code 128 Length Control	00 (variable)	00 (variable)	00 (variable)	00 (variable)	00 (variable)	00 (variable)	00 (variable)	00 (variable)
Code 128 Length 1	01	01	01	01	01	01	01	01
Code 128 Length 2	80	80	80	80	80	80	80	80
Code 128 Stitching	01 (enable)	01 (enable)	01 (enable)	01 (enable)	01 (enable)	01 (enable)	01 (enable)	01 (enable)
EAN-128 Enable	00 (disable)	00 (disable)	00 (disable)	00 (disable)	00 (disable)	00 (disable)	00 (disable)	00 (disable)
Interleaved 2 of 5 (I 2 OF 5) Enable	00 (disable)	00 (disable)	00 (disable)	00 (disable)	00 (disable)	00 (disable)	00 (disable)	00 (disable)
I 2 of 5 Check Character Calculation	00 (disable)	00 (disable)	00 (disable)	00 (disable)	00 (disable)	00 (disable)	00 (disable)	00 (disable)
I 2 of 5 Check Character Transmission	01 (enable)	01 (enable)	01 (enable)	01 (enable)	01 (enable)	01 (enable)	01 (enable)	01 (enable)
I 2 of 5 Minimum Read	01 (1 read)	01 (1 read)	01 (1 read)	01 (1 read)	01 (1 read)	01 (1 read)	01 (1 read)	01 (1 read)
I 2 of 5 Correlation	00 (disable)	00 (disable)	00 (disable)	00 (disable)	00 (disable)	00 (disable)	00 (disable)	00 (disable)
I 2 of 5 Length Control	00 (variable)	00 (variable)	00 (variable)	00 (variable)	00 (variable)	00 (variable)	00 (variable)	00 (variable)
I 2 of 5 Length 1	06	06	06	06	06	06	06	06
I 2 of 5 Length 2	50	50	50	50	50	50	50	50
I 2 of 5 Stitching	00 (disable)	00 (disable)	00 (disable)	00 (disable)	00 (disable)	00 (disable)	00 (disable)	00 (disable)
Codabar Enable	00 (disable)	00 (disable)	00 (disable)	00 (disable)	00 (disable)	00 (disable)	00 (disable)	00 (disable)
Codabar Start Stop Character Transmission	01 (enable)	01 (enable)	01 (enable)	01 (enable)	01 (enable)	01 (enable)	01 (enable)	01 (enable)
Codabar Start Stop Character Set	03 (abcd/abcd)	03 (abcd/abcd)	03 (abcd/abcd)	03 (abcd/abcd)	03 (abcd/abcd)	03 (abcd/abcd)	03 (abcd/abcd)	03 (abcd/abcd)
Codabar Start Stop Character Match	00 (disable)	00 (disable)	00 (disable)	00 (disable)	00 (disable)	00 (disable)	00 (disable)	00 (disable)
Codabar Check Character Calculation	00 (disable)	00 (disable)	00 (disable)	00 (disable)	00 (disable)	00 (disable)	00 (disable)	00 (disable)
Codabar Check Character Transmission	01 (enable)	01 (enable)	01 (enable)	01 (enable)	01 (enable)	01 (enable)	01 (enable)	01 (enable)
Codabar Minimum Read	01 (1 read)	01 (1 read)	01 (1 read)	01 (1 read)	01 (1 read)	01 (1 read)	01 (1 read)	01 (1 read)

FACTORY DEFAULTS

Feature	Default Master	RS-232	RS-232 Wincor-Nixdorf	RS-232 Single Cable	Key-board	USB COM / USB-TEC	USB OEM	IBM Port 17 Port 9B Port 5B
Codabar Correlation	00 (dis-able)	00 (dis-able)	00 (dis-able)	00 (dis-able)	00 (dis-able)	00 (dis-able)	00 (dis-able)	00 (dis-able)
Codabar Length Control	00 (variable)	00 (variable)	00 (variable)	00 (variable)	00 (variable)	00 (variable)	00 (variable)	00 (variable)
Codabar Length 1	03	03	03	03	03	03	03	03
Codabar Length 2	50	50	50	50	50	50	50	50
Codabar Stitching	00 (dis-able)	00 (dis-able)	00 (dis-able)	00 (dis-able)	00 (dis-able)	00 (dis-able)	00 (dis-able)	00 (dis-able)
Codabar Require Margins	00 (dis-able)	00 (dis-able)	00 (dis-able)	00 (dis-able)	00 (dis-able)	00 (dis-able)	00 (dis-able)	00 (dis-able)
Code 93 Enable	00 (dis-able)	00 (dis-able)	00 (dis-able)	00 (dis-able)	00 (dis-able)	00 (dis-able)	00 (dis-able)	00 (dis-able)
Code 93 Minimum Read	01 (1 read)	01 (1 read)	01 (1 read)	01 (1 read)	01 (1 read)	01 (1 read)	01 (1 read)	01 (1 read)
Code 93 Correlation	00 (dis-able)	00 (dis-able)	00 (dis-able)	00 (dis-able)	00 (dis-able)	00 (dis-able)	00 (dis-able)	00 (dis-able)
Code 93 Length Control	00 (variable)	00 (variable)	00 (variable)	00 (variable)	00 (variable)	00 (variable)	00 (variable)	00 (variable)
Code 93 Length 1	01	01	01	01	01	01	01	01
Code 93 Length 2	50	50	50	50	50	50	50	50
Code 93 Stitching	01 (enable)	01 (enable)	01 (enable)	01 (enable)	01 (enable)	01 (enable)	01 (enable)	01 (enable)
MSI Enable	00 (dis-able)	00 (dis-able)	00 (dis-able)	00 (dis-able)	00 (dis-able)	00 (dis-able)		
MSI Check Character Calculation	01 (enable)	01 (enable)	01 (enable)	01 (enable)	01 (enable)	01 (enable)		
MSI Number of Check Characters	00 (1 char)	00 (1 char)	00 (1 char)	00 (1 char)	00 (1 char)	00 (1 char)		
MSI Check Character Transmission	01 (enable)	01 (enable)	01 (enable)	01 (enable)	01 (enable)	01 (enable)		
MSI Minimum Read	01 (1 read)	01 (1 read)	01 (1 read)	01 (1 read)	01 (1 read)	01 (1 read)		
MSI Correlation	00 (dis-able)	00 (dis-able)	00 (dis-able)	00 (dis-able)	00 (dis-able)	00 (dis-able)		
MSI Length Control	00 (variable)	00 (variable)	00 (variable)	00 (variable)	00 (variable)	00 (variable)		
MSI Length 1	04	04	04	04	04	04		
MSI Length 2	16	16	16	16	16	16		
MSI Stitching	00 (dis-able)	00 (dis-able)	00 (dis-able)	00 (dis-able)	00 (dis-able)	00 (dis-able)		
Standard 2 of 5 Enable	00 (dis-able)	00 (dis-able)	00 (dis-able)	00 (dis-able)	00 (dis-able)	00 (dis-able)	00 (dis-able)	00 (dis-able)
Standard 2 of 5 Check Character Calculation	00 (dis-able)	00 (dis-able)	00 (dis-able)	00 (dis-able)	00 (dis-able)	00 (dis-able)	00 (dis-able)	00 (dis-able)
Standard 2 of 5 Check Character Transmission	01 (enable)	01 (enable)	01 (enable)	01 (enable)	01 (enable)	01 (enable)	01 (enable)	01 (enable)
Standard 2 of 5 Minimum Read	01 (1 read)	01 (1 read)	01 (1 read)	01 (1 read)	01 (1 read)	01 (1 read)	01 (1 read)	01 (1 read)

Feature	Default Master	RS-232	RS-232 Wincor-Nixdorf	RS-232 Single Cable	Key-board	USB COM / USB-TEC	USB OEM	IBM Port 17 Port 9B Port 5B
Standard 2 of 5 Correlation	00 (dis-able)	00 (dis-able)	00 (dis-able)	00 (dis-able)	00 (dis-able)	00 (dis-able)	00 (dis-able)	00 (dis-able)
Standard 2 of 5 Length Control	00 (variable)	00 (variable)	00 (variable)	00 (variable)	00 (variable)	00 (variable)	00 (variable)	00 (variable)
Standard 2 of 5 Length 1	08	08	08	08	08	08	08	08
Standard 2 of 5 Length 2	50	50	50	50	50	50	50	50
Standard 2 of 5 Stitching	00 (dis-able)	00 (dis-able)	00 (dis-able)	00 (dis-able)	00 (dis-able)	00 (dis-able)	00 (dis-able)	00 (dis-able)
2D SYMBOLOGY PROGRAMMING								
Data Matrix Enable	00 (dis-able)	00 (dis-able)	00 (dis-able)	00 (dis-able)	00 (dis-able)	00 (dis-able)	00 (dis-able)	00 (dis-able)
Data Matrix Length Control	00 (variable)	00 (variable)	00 (variable)	00 (variable)	00 (variable)	00 (variable)	00 (variable)	00 (variable)
Set Data Matrix Length 1	0001	0001	0001	0001	0001	0001	0001	0001
Set Data Matrix Length 2	0800	0800	0800	0800	0800	0800	0800	0800
GS1 Datamatrix Enable	00 (dis-able)	00 (dis-able)	00 (dis-able)	00 (dis-able)	00 (dis-able)	00 (dis-able)	00 (dis-able)	00 (dis-able)
PDF 417 Enable	01 (enable)	01 (enable)	01 (enable)	01 (enable)	01 (enable)	01 (enable)	01 (enable)	01 (enable)
PDF 417 Length Control	00 (variable)	00 (variable)	00 (variable)	00 (variable)	00 (variable)	00 (variable)	00 (variable)	00 (variable)
Set PDF 417 Length 1	0001	0001	0001	0001	0001	0001	0001	0001
Set PDF 417 Length 2	2710	2710	2710	2710	2710	2710	2710	2710
PDF 417 Read Option	00 (none)	00 (none)	00 (none)	00 (none)	00 (none)	00 (none)	00 (none)	00 (none)
Micro PDF 417 Enable	00 (dis-able)	00 (dis-able)	00 (dis-able)	00 (dis-able)	00 (dis-able)	00 (dis-able)	00 (dis-able)	00 (dis-able)
Micro PDF 417 Length Control	00 (variable)	00 (variable)	00 (variable)	00 (variable)	00 (variable)	00 (variable)	00 (variable)	00 (variable)
Set Micro PDF 417 Length 1	0001	0001	0001	0001	0001	0001	0001	0001
Set Micro PDF 417 Length 2	0366	0366	0366	0366	0366	0366	0366	0366
Micro PDF 417 128 Emulation	00 (Micro PDF 417 AIM ID & label type)	00 (Micro PDF 417 AIM ID & label type)	00 (Micro PDF 417 AIM ID & label type)	00 (Micro PDF 417 AIM ID & label type)	00 (Micro PDF 417 AIM ID & label type)	00 (Micro PDF 417 AIM ID & label type)	00 (Micro PDF 417 AIM ID & label type)	00 (Micro PDF 417 AIM ID & label type)
QR Code Enable	00 (dis-able)	00 (dis-able)	00 (dis-able)	00 (dis-able)	00 (dis-able)	00 (dis-able)	00 (dis-able)	00 (dis-able)
QR Code Length Control	00 (variable)	00 (variable)	00 (variable)	00 (variable)	00 (variable)	00 (variable)	00 (variable)	00 (variable)
Set QR Code Length 1	0001	0001	0001	0001	0001	0001	0001	0001
Set QR Code Length 2	2710	2710	2710	2710	2710	2710	2710	2710
GS1 QR Code Enable	00 (dis-able)	00 (dis-able)	00 (dis-able)	00 (dis-able)	00 (dis-able)	00 (dis-able)	00 (dis-able)	00 (dis-able)

FACTORY DEFAULTS

Feature	Default Master	RS-232	RS-232 Wincor-Nixdorf	RS-232 Single Cable	Key-board	USB COM / USB-TEC	USB OEM	IBM Port 17 Port 9B Port 5B
QR Code URL Link Enable	00 (dis-able)	00 (dis-able)	00 (dis-able)	00 (dis-able)	00 (dis-able)	00 (dis-able)	00 (dis-able)	00 (dis-able)
Micro QR Code Enable	00 (dis-able)	00 (dis-able)	00 (dis-able)	00 (dis-able)	00 (dis-able)	00 (dis-able)	00 (dis-able)	00 (dis-able)
Micro QR Code Length Control	00 (variable)	00 (variable)	00 (variable)	00 (variable)	00 (variable)	00 (variable)	00 (variable)	00 (variable)
Set Micro QR Code Length 1	0001	0001	0001	0001	0001	0001	0001	0001
Set Micro QR Code Length 2	3700	3700	3700	3700	3700	3700	3700	3700
Aztec Enable	00 (dis-able)	00 (dis-able)	00 (dis-able)	00 (dis-able)	00 (dis-able)	00 (dis-able)	00 (dis-able)	00 (dis-able)
Aztec Length Control	00 (variable)	00 (variable)	00 (variable)	00 (variable)	00 (variable)	00 (variable)	00 (variable)	00 (variable)
Set Aztec Length 1	0001	0001	0001	0001	0001	0001	0001	0001
Set Aztec Length 2	3700	3700	3700	3700	3700	3700	3700	3700

NOTES

APPENDIX G

HANDHELD DATA FORMAT REQUIREMENTS

This appendix provides application notes to describe the general format of data that can be accepted by the scanner through the auxiliary port as transmitted from a handheld scanner.

HANDHELD DATA FORMAT REQUIREMENTS GENERAL

- USB handhelds enumerate as a CDC ACM serial device.
- USB devices should also bracket the data with the RTS equivalent.
- The time between character transmission can be no longer than 50 milliseconds.
- Symbologies requiring fixed lengths (UPC/EAN) will enforce length requirements for validation of the label.
- Handheld will be required to transmit start and stop characters for Codabar and Code39 labels.
- Appropriate industrial length requirements will be enforced (if configured) for validation of the label.
- Maximum label lengths will be enforced for label validation (i.e. labels longer than the maximum label size will not be validated).
- Standard Datalogic formats generally use a single prefix character. see specific formats section.
- Maximum label size allowed including identifiers is 2714 bytes
- Recommendations:
 - Handheld should not be configured for audible label read indication.
 - Handheld should not be configured for visual label read indication.
 - Handheld should not be configured for continuous label read mode.

DATALOGIC HANDHELD DATA FORMAT REQUIREMENTS

The following sections describe label transmission formats that are typically observed in factory configurations of Datalogic handheld scanners.

UPC-A

- Number system must be included in label data
- Check digit must be included in label data and is assumed to be correct
- Prefix must be an ASCII character 'A' - total length including prefix must be 13
- Example: 'A060992011187'

UPC-A with 2-Digit Supplemental

- Number system must be included in label data
- Check digit must be included in label data and is assumed to be correct
- Supplemental data is appended to base label
- Prefix must be an ASCII character 'A' - total length including prefix must be 15
- Example: 'A06099201118712'

UPC-A with 5-Digit Supplemental

- Number system must be included in label data
- Check digit must be included in label data and is assumed to be correct
- Prefix must be an ASCII character 'A' - total length including prefix must be 18
- Example: 'A06099201118712345'

UPC-A with Code128 Supplemental

- Number system must be included in label data
- Check digit must be included in label data and is assumed to be correct
- Supplemental data is appended to base label
- Prefix must be an ASCII character 'A' - total length including prefix must be greater or equal to 19 (code 128 supplemental codes are variable length having a minimum of 2 data characters)
- Characters immediately following base label must be of the form '8100', '8101' or '8102'
- Example: 'A060992011187810000951'

UPC-E

- Number system must be included in label data
- Check digit must be included in label data and is assumed to be correct
- Prefix must be an ASCII character 'E' - total length including prefix must be 9
- Example: 'E09988750'

UPC-E with 2-Digit Supplemental

- Number system must be included in label data
- Check digit must be included in label data and is assumed to be correct
- Supplemental data is appended to base label
- Prefix must be an ASCII character 'E' - total length including prefix must be 11
- Example: 'E0998875012'

UPC-E with 5-Digit Supplemental

- Number system must be included in label data
- Check digit must be included in label data and is assumed to be correct
- Prefix must be an ASCII character 'E' - total length including prefix must be 14
- Example: 'E0998875012345'

UPC-E with Code 128 Supplemental

- Number system must be included in label data
- Check digit must be included in label data and is assumed to be correct
- Supplemental data is appended to base label
- Prefix must be an ASCII character 'E' - total length including prefix must be greater or equal to 15 (code 128 supplemental codes are variable length having a minimum of 2 data characters)
- Characters immediately following base label must be of the form '8100', '8101' or '8102'
- Example: 'E099887508101000951'

EAN8

- Check digit must be included in label data and is assumed to be correct
- Prefix must be an ASCII characters 'FF' - total length including prefix must be 10
- Example: 'FF00210126'

EAN8 with 2-Digit Supplemental

- Check digit must be included in label data and is assumed to be correct
- Supplemental data is appended to base label
- Prefix must be an ASCII characters 'FF' - total length including prefix must be 12
- Example: 'FF0021012612'

EAN8 with 5-Digit Supplemental

- Check digit must be included in label data and is assumed to be correct
- Prefix must be an ASCII characters 'FF' - total length including prefix must be 15
- Example: 'FF0021012612345'

EAN8 with Code 128 Supplemental

- Check digit must be included in label data and is assumed to be correct
- Supplemental data is appended to base label
- Prefix must be an ASCII characters 'FF' - total length including prefix must be greater than 16 (code 128 supplemental codes are variable length having a minimum of 2 data characters)
- Characters immediately following base label must be of the form '8100', '8101' or '8102'
- Example: 'FF002101268102000951'

EAN13

- Check digit must be included in label data and is assumed to be correct
- Prefix must be an ASCII character 'F' - total length including prefix must be 14
- Example: 'F1101234567891'

EAN13 with 2-Digit Supplemental

- Check digit must be included in label data and is assumed to be correct
- Supplemental data is appended to base label
- Prefix must be an ASCII character 'F'- total length including prefix must be 16
- Example: 'F110123456789112'

EAN13 with 5-Digit Supplemental

- Check digit must be included in label data and is assumed to be correct
- Prefix must be an ASCII character 'F'- total length including prefix must be 19
- Example: 'F110123456789112345'

EAN13 with Code128 Supplemental

- Check digit must be included in label data and is assumed to be correct
- Supplemental data is appended to base label
- Prefix must be an ASCII character 'F'- total length including prefix must be greater or equal to 20 (code 128 supplemental codes are variable length having a minimum of 2 data characters)
- Characters immediately following base label must be of the form '8100', '8101' or '8102'
- Example: 'F11012345678918100000951'

Code 39

- Check character must be included in label data
- Label length including start, stop and check characters and excluding prefix character must meet requirements imposed by the main scanner's fixed or variable label length control for this symbology type.
- Start and stop characters "*" must be included in label
- Prefix must be an ASCII character '*'
- Example : '**CODE39.TEST*'

Code 39-Pharmacode (Code 32)

- Check character must be included in label data
- Label length including start, stop and check characters and excluding prefix character must meet requirements imposed by the main scanner's fixed or variable label length control for this symbology type.
- Start and stop characters "*" must be included in label
- Prefix must be an ASCII character 'p'
- Example: 'p*123456789*'

Interleaved 2 of 5 (I 2 of 5)

- Check character must be included in label data
- Label length including check characters and excluding prefix character must meet requirements imposed by the main scanner's fixed or variable label length control for this symbology type.
- Prefix must be an ASCII character 'i'
- Example: '*i0123456789'

Codabar

- Check character must be included in label data
- Label length including check character and excluding prefix character must meet requirements imposed by the main scanner's fixed or variable label length control for this symbology type.
- Prefix must be an ASCII character '%'
- Start stop character sets must meet the matching requirement set forth by the scanner configuration item CI_CBAR_START_STOP_CHAR_MATCH
- Start stop character sets s must be of the form ABCD/ABCD and must be included in the label
- Example: '%s\$99.95s'

Code 128

- Prefix must be an ASCII character '#'
- Label length excluding prefix character must meet requirements imposed by the main scanner's fixed or variable label length control for this symbology type.
- Function characters may be transmitted as a hexadecimal value 8x. Where x correlates to function characters 1 thru 4 as follows:
 - x80 = function code 1
 - x81 = function code 2
 - x82 = function code 3
 - x83 = function code 4
- For Code128 programming labels the format is of the general form '#/82nnnnn/r' - /82 is hexadecimal 82 and /r is carriage return
- Example: '#Code_128.Test'

MSI Plessey

- Check character must be included in label data
- Label length including check character and excluding prefix character must meet requirements imposed by the main scanner's fixed or variable label length control for this symbology type.
- Prefix must be an ASCII character '@'
- Example: '@144769254'

Code 93

- Prefix must be an ASCII character '&'
- Label length excluding prefix character must meet requirements imposed by the main scanner's fixed or variable label length control for this symbology type.
- Example: '&Code93-test'

GS1 DataBar Omnidirectional

- Prefix must be ASCII characters 'R4'
- Check character must be included in label
- Application identifier "01" must follow the prefix and precede the base label
- Label length excluding prefix characters must be 16 characters.
- Example: 'R40101044123456789'

GS1 DataBar Expanded

- Prefix must be ASCII characters 'R4'

- Label length excluding prefix characters must be at least 1 character. Maximum length is the maximum label size supported by the scanner.
- The format of the label must not be of the same format as RSS-14 (application id '01' & length equal to 16)
- Example: 'R4002900123456789083103001750'

Standard 2 of 5 (S 2 of 5)

- Prefix must be ASCII character 's'
- Label length excluding prefix character must meet requirements imposed by the main scanner's fixed or variable label length control for this symbology type.
- Example 's1234567890'

PDF 417

- Prefix must be ASCII character 'P'
- Label length excluding prefix character cannot exceed 2714 characters +3, or 2717 characters. In addition to this, label length excluding prefix character must meet requirements imposed by the main scanner's fixed or variable label length control for this symbology type.
- Example: 'Ppdf test label'

AIM Formats

AIM specifies a 3-character string that is attached as a prefix to the label data for transmission. Because AIM specifies one identifier for UPCA, UPCE and EAN13 labels, UPCA, UPCE and EAN13 will be received from the handheld and transmitted by the scanner as EAN13. The 'J' character must be the first character received in the label transmission from the handheld.

The following sections describe the prefix strings and identify what specific label characteristics can be supported.

UPC-A

- AIM does not specify UPCA as a separate symbology using this transmission format - labels will be transmitted as EAN13 (refer to section 8.5.4.3).
- Examples: 'JE00060992011187' or 'JE30060992011187'

UPC-E

- AIM does not specify UPCE as a separate symbology using this transmission format - labels will be transmitted as EAN13 (refer to section 8.5.4.3)..
- Examples: 'JE00000000998875' or 'JE30000000998875'

EAN13

- Check digit must be included in label data and is assumed to be correct.
- Prefix must be ASCII characters 'JE0' or 'JE3'.
- Total length including prefix must be 16.
- Examples: 'JE01101234567891' or 'JE31101234567891'.

EAN8

- Check digit must be included in label data and is assumed to be correct.
- Prefix must be ASCII characters 'JE4'.
- Total length including prefix must be 11.
- Example: 'JE400210126'

2-Digit Add-on

- Add-on data is appended to the end of an EAN base label.
- If the main label has an AIM Id prefix with the ASCII characters ']E0', the add-on data must have an AIM Id prefix with the ASCII characters ']E1'.
- If the add-on data has an AIM Id prefix, the length of add-on data including AIM Id prefix must be 5.
- If the main label has an AIM Id prefix with the ASCII characters ']E3', the add-on data does not have an AIM Id prefix.
- If the add-on data does not have an AIM Id prefix, the length of add-on data must be 2.
- Examples: add-on portion is highlighted data is underlined

UPC-A 2-digit add-on	']E00060992011187] <u>JE112</u> '
UPC-E 2-digit add-on	']E00000000998875] <u>JE112</u> '
EAN8 2-digit add-on	']E400210126] <u>JE112</u> '
EAN13 2-digit add-on	']E01101234567891] <u>JE112</u> '
UPC-A 2-digit add-on	']E30060992011187] <u>12</u> '
UPC-E 2-digit add-on	']E30000000998875] <u>12</u> '
EAN13 2-digit add-on	']E31101234567891] <u>12</u> '

5-Digit Add-on

- Add-on data is appended to the end of an EAN base label.
- If the main label has an AIM Id prefix with the ASCII characters ']E0', the add-on data must have an AIM Id prefix with the ASCII characters ']E2'.
- If the add-on data has an AIM Id prefix, the length of add-on data including AIM Id prefix must be 8.
- If the main label has an AIM Id prefix with the ASCII characters ']E3', the add-on data does not have an AIM Id prefix.
- If the add-on data does not have an AIM Id prefix, the length of add-on data must be 5.
- Examples: add-on portion is highlighted data is underlined

UPC-A 5-digit add-on	']E00060992011187] <u>JE212345</u> '
UPC-E 5-digit add-on	']E00000000998875] <u>JE212345</u> '
EAN8 5-digit add-on	']E400210126] <u>JE212345</u> '
EAN13 5-digit add-on	']E01101234567891] <u>JE212345</u> '
UPC-A 5-digit add-on	']E30060992011187] <u>12345</u> '
UPC-E 5-digit add-on	']E30000000998875] <u>12345</u> '
EAN13 5-digit add-on	']E31101234567891] <u>12345</u> '

Code128 Add-on

Code 128 add-on is not supported in the AIM format.

Bookland

- The 'Bookland' / ISBN code will be formatted as a vendor specific AIM label.
- Prefix must be ASCII characters ']X0'
- Length of label data including prefix is 13.
- Examples: ']X01234567890'

Code 39

- Check character must be included in label data
- Label length including start, stop and check characters and excluding prefix characters must meet requirements imposed by the main scanner's fixed or variable label length control for this symbology type.
- Start and stop characters "*" must be included in label
- Prefix must be ASCII characters ']A0' or ']A1'
- Example: ']A0*CODE39.TEST*'

Codabar

- Check character must be included in label data
- Label length including check character and excluding prefix characters must meet requirements imposed by the main scanner's fixed or variable label length control for this symbology type.
- Prefix must be ASCII characters ']F0'
- Start stop character sets must meet the matching requirement set forth by the scanner configuration item CI_CBAR_START_STOP_CHAR_MATCH
- Start stop character sets s must be of the form ABCD/ABCD and must be included in the label
- Example: ']F0s\$99.95s'

MSI Plessey

- Check character must be included in label data
- Label length including check character and excluding prefix characters must meet requirements imposed by the main scanner's fixed or variable label length control for this symbology type.
- Prefix must be ASCII characters ']M0'
- Example: ']M0144769254'

Code 93

- Prefix must be ASCII characters ']G0'
- Label length excluding prefix characters must meet requirements imposed by the main scanner's fixed or variable label length control for this symbology type.
- Example : ']G0Code93-test'

GS1 DataBar Omnidirectional

- Prefix must be ASCII characters ']e0'
- Check character must be included in label
- Application identifier "01" must follow the prefix and precede the base label
- Label length excluding prefix characters must be 16 characters.
- Example: ']e00101044123456789'

GS1 DataBar Expanded

- Prefix must be ASCII characters 'je0'
- Label length excluding prefix characters must be at least 1 character. Maximum length is the maximum label size supported by the scanner.
- The format of the label must not be of the same format as RSS-14 (application id & length equal to 16)
- Example: 'je002900123456789083103001750'

Interleaved 2 of 5 (I 2 of 5)

- Check character must be included in label data
- Label length including check characters and excluding prefix characters must meet requirements imposed by the main scanner's fixed or variable label length control for this symbology type.
- Prefix must be an ASCII character 'jI1' (other prefixes specify different check character properties which are not supported).
- Example: 'jI10123456789'

Code 128 / EAN 128

- Prefix must be either ASCII characters 'jC0', 'jC1' or 'jC2'
- Label length excluding prefix character must meet requirements imposed by the main scanner's fixed or variable label length control for this symbology type.
- If CI_EAN128D is TRUE and prefix is 'jC1', label will be identified as an EAN128 otherwise it is identified as a Code 128.
- A prefix of 'jC0' designates that no function code is present in the 1st or 2nd character position
- A prefix of 'jC2' designates that a function code 1 is present in the 2nd character.
- Example : 'jC0Code_128.Test'

Standard 2 of 5 (S 2 of 5)

- Prefix must be ASCII characters 'jS0'
- Label length excluding prefix characters must meet requirements imposed by the main scanner's fixed or variable label length control for this symbology type.
- Example : 'jS01234567890'

PDF 417

- Prefix must be ASCII characters 'jL0' thru 'jL5' ('0' thru '5' inclusive)
- Label length excluding prefix character must meet requirements imposed by the main scanner's fixed or variable label length control for this symbology type.
- Example : 'jL0pdf_test_label'

Data Matrix

- Prefix must be ASCII characters 'jd0' thru 'jd6' ('0' thru '6' inclusive)
- Label length excluding prefix character must meet requirements imposed by the main scanner's fixed or variable label length control for this symbology type.
- Example : 'jd0dm_label_test'

Aztec

- Prefix must be ASCII characters 'jz0' thru 'jzC' ('0' thru 'C' inclusive 0-9,A-C)
- Label length excluding prefix character must meet requirements imposed by the main scanner's fixed or variable label length control for this symbology type.
- Example : 'jz0aztec_label_test'

QR Code

- Prefix must be ASCII characters `]Q0' thru `]Q6' ('0' thru '6' inclusive)
- Label length excluding prefix character must meet requirements imposed by the main scanner's fixed or variable label length control for this symbology type.
- AIM does not distinguish QR from micor QR so devices may read microQR but transmit and be interpreted as QR.
- Example : `]Q0QR_label_test'

Labels with an "unknown" AIM Id (an AIM Id not specified above)

- If a label is received that does not have an AIM Id specified above, and the first 3 label characters qualify as follows:
 - the first characters is a `]'
 - the second character is a capital or small letter
 - the third character is a digit
- then the label type is set to GENERIC_DATA and the "unknown" AIM Id is left appended to the beginning of the label data.

NOTES

ASCII Character Set

ASCII Char.	Hex No.	ASCII Char.	Hex No.	ASCII Char.	Hex No.	ASCII Char.	Hex No.
NUL	00	SP	20	@	40	'	60
SOH	01	!	21	A	41	a	61
STX	02	"	22	B	42	b	62
ETX	03	#	23	C	43	c	63
EOT	04	\$	24	D	44	d	64
ENQ	05	%	25	E	45	e	65
ACK	06	&	26	F	46	f	66
BEL	07	'	27	G	47	g	67
BS	08	(28	H	48	h	68
HT	09)	29	I	49	i	69
LF	0A	*	2A	J	4A	j	6A
VT	0B	+	2B	K	4B	k	6B
FF	0C	,	2C	L	4C	l	6C
CR	0D	-	2D	M	4D	m	6D
SO	0E	.	2E	N	4E	n	6E
SI	0F	/	2F	O	4F	o	6F
DLE	10	0	30	P	50	p	70
DC1	11	1	31	Q	51	q	71
DC2	12	2	32	R	52	r	72
DC3	13	3	33	S	53	s	73
DC4	14	4	34	T	54	t	74
NAK	15	5	35	U	55	u	75
SYN	16	6	36	V	56	v	76
ETB	17	7	37	W	57	w	77
CAN	18	8	38	X	58	x	78
EM	19	9	39	Y	59	y	79
SUB	1A	:	3A	Z	5A	z	7A
ESC	1B	;	3B	[5B	{	7B
FS	1C	<	3C	\	5C		7C
GS	1D	=	3D]	5D	}	7D
RS	1E	>	3E	^	5E	~	7E
US	1F	?	3F	_	5F	DEL	7F

© 2022-2023 Datalogic S.p.A. and /or its affiliates • All rights reserved • Without limiting the rights under copyright, no part of this documentation may be reproduced, stored in or introduced into a retrieval system, or transmitted in any form or by any means, or for any purpose, without the express written permission of Datalogic S.p.A. and/or its affiliates • Datalogic and the Datalogic logo are registered trademarks of Datalogic S.p.A. in many countries, including the U.S. and the E.U.

 **DATALOGIC**
www.datalogic.com

Datalogic S.r.l.

Via S. Vitalino, 13
40012 Calderara di Reno (BO)
Italy
Tel. +39 051 3147011
Fax +39 051 3147205



800000020

(Rev C)

January 2023