



FR4050

Presentation Scanner

User Guide

Disclaimer

© 2015-2016 Fujian Newland Auto-ID Tech. Co., Ltd. All rights reserved.

Please read through the manual carefully before using the product and operate it according to the manual. It is advised that you should keep this manual for future reference.

Do not disassemble the device or remove the seal label from the device, doing so will void the product warranty provided by Fujian Newland Auto-ID Tech. Co., Ltd.

All pictures in this manual are for reference only and actual product may differ. Regarding to the product modification and update, Fujian Newland Auto-ID Tech. Co., Ltd. reserves the right to make changes to any software or hardware to improve reliability, function, or design at any time without notice. The information contained herein is subject to change without prior notice.

The products depicted in this manual may include software copyrighted by Fujian Newland Auto-ID Tech. Co., Ltd or third party. The user, corporation or individual, shall not duplicate, in whole or in part, distribute, modify, decompile, disassemble, decode, reverse engineer, rent, transfer or sublicense such software without prior written consent from the copyright holders.

This manual is copyrighted. No part of this publication may be reproduced, distributed or used in any form without written permission from Newland.

Fujian Newland Auto-ID Tech. Co., Ltd. reserves the right to make final interpretation of the statement above.

Fujian Newland Auto-ID Tech. Co., Ltd.

3F, Building A, No.1, Rujiang West Rd., Mawei, Fuzhou, Fujian, China 350015

<http://www.nlscan.com>

Revision History

Version	Description	Date
V1.0.0	Initial release.	April 10, 2015
V1.0.1	<ol style="list-style-type: none">1. Added the Enable/Disable the Switch and Auto Sleep features in Chapter 3.2. Added the USB Suspend feature in Chapter 5.3. Added the 1D Twin Code, Enable/Disable PDF417 ECI Output, Enable/Disable QR ECI Output, Enable/Disable Aztec ECI Output, Enable/Disable Data Matrix ECI Output and ISSN features in Chapter 6.4. Added the programming data format with batch command feature in Chapter 10. <p>Note: You must have firmware version V3.06.106 or higher to use the new features above.</p>	August 23, 2016
V1.0.2	Added the USB HID-KBW Fast Mode and Speed features in Chapter 5.	November 11, 2016

Table of Contents

Revision History	3
Preface	13
Introduction	13
Chapter Description	13
Explanation of Icons	14
Chapter 1 Getting Started	15
Introduction	15
Features of the FR40	15
Unpacking	15
FR40 Scanner	16
Data Port Pinout	17
Connect FR40 to a Host	17
Use USB Cable	18
Use RS-232 Cable	19
Power On, Sleep, Power Off, Reboot	20
Maintenance	20
Dimensions (unit: mm)	21
Left View	21
Front View	21
Right View	22
Scanning Instructions	23
Chapter 2 QuickSet	24
Chapter 3 System Settings	25
Introduction	25
Barcode Programming	25
Command Programming	25
QuickSet Programming	25
Programming Barcode/Command/Function	26
Use of Programming Barcodes	26
Illumination	27

Beep.....	28
Good Read Beep	28
Good Read Beep Type	28
Good Read Beep Duration (Type 1).....	29
Good Read Beep Frequency (Type 1)	29
Good Read Beep Volume	30
Startup Beep	30
Beep Definitions.....	30
Scan Mode.....	31
Enable/Disable the Switch	31
Auto Sleep	32
Decode Area	33
Whole Area Decoding	33
Central Area Decoding.....	33
Specify Central Area	33
Default Settings.....	34
Factory Defaults.....	34
Custom Defaults	34
Product Information.....	35
Chapter 4 RS-232 Interface.....	37
Introduction	37
RS-232 Parameters	37
Baud Rate	38
Parity Check	39
Data Bit	40
Stop Bit	40
Hardware Auto Flow Control	41
Chapter 5 USB Interface	42
Introduction	42
USB Suspend	42
USB HID-KBW	43
Fast Mode.....	43
USB HID-KBW Speed.....	44
USB Country Keyboard Types	45

Country Code Table	46
Beep on Unknown Character	47
Emulate ALT+Keypad	48
Function Key Mapping	49
ASCII Function Key Mapping Table	50
ASCII Function Key Mapping Table (Continued).....	51
Inter-Keystroke Delay	52
Caps Lock	53
Convert Case	54
Emulate Numeric Keypad	55
USB DataPipe.....	57
USB COM Port Emulation.....	58
USB HID-POS.....	58
Introduction	58
Access the Scanner with Your Program.....	59
Acquire Scanned Data	59
VID/PID.....	59
Chapter 6 Symbologies	60
Introduction	60
General Settings	60
Disable All Symbologies.....	60
Enable All Symbologies	60
Enable 1D Symbologies.....	61
Disable 1D Symbologies.....	61
Enable 2D Symbologies.....	61
Disable 2D Symbologies.....	61
1D Twin Code	62
Code 128	63
Restore Factory Defaults	63
Enable/Disable Code 128	63
Set Length Range for Code 128	64
EAN-8	65
Restore Factory Defaults	65
Enable/Disable EAN-8	65
Transmit Check Digit.....	66
2-Digit Add-On Code.....	66

5-Digit Add-On Code.....	67
EAN-8 Extension.....	67
EAN-13	68
Restore Factory Defaults	68
Enable/Disable EAN-13	68
Transmit Check Digit.....	69
2-Digit Add-On Code.....	69
5-Digit Add-On Code.....	70
UPC-E.....	71
Restore Factory Defaults	71
Enable/Disable UPC-E.....	71
Transmit Check Digit.....	72
2-Digit Add-On Code.....	72
5-Digit Add-On Code.....	73
Transmit System Character —0.....	74
UPC-E Extension.....	74
UPC-A.....	75
Restore Factory Defaults	75
Enable/Disable UPC-A.....	75
Transmit Check Digit.....	76
2-Digit Add-On Code.....	76
5-Digit Add-On Code.....	77
Transmit Preamble Character —0.....	78
Interleaved 2 of 5	79
Restore Factory Defaults	79
Enable/Disable Interleaved 2 of 5	79
Set Length Range for Interleaved 2 of 5	80
Check Digit Verification	81
Set Discrete Lengths for Interleaved 2 of 5.....	82
ITF-14	84
ITF-6	85
Matrix 2 of 5	86
Restore Factory Defaults	86
Enable/Disable Matrix 2 of 5	86
Set Length Range for Matrix 2 of 5	87
Check Digit Verification	88

Code 39	89
Restore Factory Defaults	89
Enable/Disable Code 39	89
Transmit Start/Stop Character	90
Set Length Range for Code 39	91
Check Digit Verification	92
Enable/Disable Code 39 Full ASCII	93
Codabar	94
Restore Factory Defaults	94
Enable/Disable Codabar	94
Set Length Range for Codabar	95
Check Digit Verification	96
Start/Stop Character	97
Code 93	98
Restore Factory Defaults	98
Enable/Disable Code 93	98
Set Length Range for Code 93	99
Check Digit Verification	100
UCC/EAN-128.....	101
Restore Factory Defaults	101
Enable/Disable UCC/EAN-128	101
GS1 Databar	102
Restore Factory Defaults	102
Enable/Disable GS1 Databar	102
Transmit Application Identifier —"0".....	103
EAN-UCC Composite.....	104
Restore Factory Defaults	104
Enable/Disable EAN-UCC Composite.....	104
Code 11.....	105
Restore Factory Defaults	105
Enable/Disable Code 11	105
Set Length Range for Code 11.....	106
Check Digit Verification	107
ISBN.....	109
Restore Factory Defaults	109
Enable/Disable ISBN	109

Set ISBN Format.....	110
Industrial 25	111
Restore Factory Defaults	111
Enable/Disable Industrial 25	111
Set Length Range for Industrial 25	112
Check Digit Verification	113
Standard 25	114
Restore Factory Defaults	114
Enable/Disable Standard 25	114
Set Length Range for Standard 25	115
Check Digit Verification	116
Plessey	117
Restore Factory Defaults	117
Enable/Disable Plessey	117
Set Length Range for Plessey	118
Check Digit Verification	119
MSI-Plessey.....	120
Restore Factory Defaults	120
Enable/Disable MSI-Plessey.....	120
Set Length Range for MSI-Plessey.....	121
Check Digit Verification	122
ISSN.....	123
Restore Factory Defaults	123
Enable/Disable ISSN	123
PDF417.....	124
Restore Factory Defaults	124
Enable/Disable PDF417.....	124
Set Length Range for PDF417.....	125
PDF417 Twin Code.....	126
PDF417 Inverse.....	127
Enable/Disable PDF417 ECI Output.....	127
QR Code	128
Restore Factory Defaults	128
Enable/Disable QR Code.....	128
Set Length Range for QR Code.....	129
QR Twin Code.....	130

Enable/Disable QR ECI Output.....	130
Aztec.....	131
Restore Factory Defaults	131
Enable/Disable Aztec Code	131
Set Length Range for Aztec Code.....	132
Read Multi-barcodes on an Image.....	133
Set the Number of Barcodes.....	134
Enable/Disable Aztec ECI Output	135
Data Matrix.....	136
Restore Factory Defaults	136
Enable/Disable Data Matrix	136
Set Length Range for Data Matrix.....	137
Data Matrix Twin Code.....	138
Rectangular Barcode	139
Data Matrix Inverse.....	139
Enable/Disable Data Matrix ECI Output.....	140
Maxicode.....	141
Restore Factory Defaults	141
Enable/Disable Maxicode	141
Set Length Range for Maxicode	142
Chinese Sensible Code.....	143
Restore Factory Defaults	143
Enable/Disable Chinese Sensible Code	143
Set Length Range for Chinese Sensible Code	144
Chinese Sensible Twin Code	145
Chinese Sensible Code Inverse.....	146
Chapter 7 Prefix & Suffix	147
Introduction	147
General Settings	148
Enable/Disable All Prefix/Suffix	148
Prefix Sequences.....	148
Custom Prefix	149
Enable/Disable Custom Prefix	149
Set Custom Prefix.....	149
AIM ID Prefix.....	150

Code ID Prefix.....	150
Restore All Default Code IDs	151
Modify Code ID	151
Custom Suffix.....	155
Enable/Disable Custom Suffix.....	155
Set Custom Suffix	155
Terminating Character Suffix.....	156
Enable/Disable Terminating Character Suffix.....	156
Set Terminating Character Suffix	157
Chapter 8 Data Extraction & Packing	158
Introduction	158
Data Extraction	158
Program 1D Extraction Option	160
Program 2D Extraction Option	162
Data Packaging.....	163
Introduction.....	163
Normal Pack	164
Chapter 9 Batch Programming.....	165
Introduction	165
Create a Batch Command.....	166
Create a Batch Barcode.....	167
Use Batch Barcode	168
Chapter 10 Data Formatter	169
Introduction	169
Add a Data Format.....	169
Programming with Barcodes	170
Programming with a Batch Command	172
Enable Data Format.....	173
Change Data Format for a Single Scan	173
Enable/Disable Data Formatter	174
Non-Match Error Beep	175
Clear Data Format	176
Query Data Formats.....	176

Formatter Command Type 6	177
Send Commands	177
Move Commands	180
Search Commands	182
Miscellaneous Commands	185
Appendix	187
Digit Barcodes	187
Save/Cancel Barcodes	189
Factory Defaults Table	190
AIM ID Table	196
Code ID Table	197
Symbology ID Number	198
ASCII Table	199

Preface

Introduction

This manual provides detailed instructions for setting up and using the NLS-FR4050 desktop barcode scanner (hereinafter referred to as **-FR40 scanner**" or **-the scanner**").

Chapter Description

- ◇ *Chapter 1, Getting Started* : Gives a general description of FR40 scanner including its technical parameters.
- ◇ *Chapter 2, QuickSet* : Introduces a useful tool you can use to set up FR40 scanner and develop new applications.
- ◇ *Chapter 3, System Settings* : Introduces three configuration methods and describes how to configure general parameters of FR40 scanner.
- ◇ *Chapter 4, RS-232 Interface* : Describes how to configure RS-232 communication parameters.
- ◇ *Chapter 5, USB Interface* : Describes how to configure USB communication parameters.
- ◇ *Chapter 6, Symbologies* : Lists all compatible symbologies and describes how to configure the relevant parameters..
- ◇ *Chapter 7, Prefix & Suffix* : Describes how to use prefix and suffix to customize scanned data.
- ◇ *Chapter 8, Data Extraction & Packing* : Describes how to extract a particular portion of scanned data and to enable data packing feature.
- ◇ *Chapter 9, Batch Programming* : Explains how to integrate a complex programming task into a single barcode.
- ◇ *Chapter 10, Data Formatter* : Explains how to customize scanned data with the data formatter.
- ◇ *Appendix* : Provides factory defaults table and a bunch of frequently used programming barcodes.

Explanation of Icons



This icon indicates something relevant to this manual.



This icon indicates this information requires extra attention from the reader.



This icon indicates handy tips that can help you use or configure the scanner with ease.



This icon indicates practical examples that can help you to acquaint yourself with operations.

Chapter 1 Getting Started

Introduction

The FR40 scanner reads a 1D or 2D barcode by capturing its image. Adopting the advanced **UIMG**® technology independently developed by Newland Auto-ID Tech, it provides users with Sense scan mode and Screen scan mode, tailored to different scanning needs.

An illustrated introduction to the FR40 scanner is included in this chapter. If you have an FR40 scanner at hand, make good use of it to develop a better understanding of this manual. This chapter is written for normal users, maintenance staff and software developers.

Features of the FR40

- Comprehensive data capture: most 1D and 2D barcodes including Chinese Sensible Code.
- Fast and accurate decoding capability: integrates high-performance processor and barcode decoder board.
- Easy to configure and update.

Unpacking

Open the package and take out FR40 scanner and its accessories. Check to make sure everything on the packing list is present and intact. If any contents are damaged or missing, please keep the original package and contact your dealer immediately for after-sales service.

FR40 Scanner

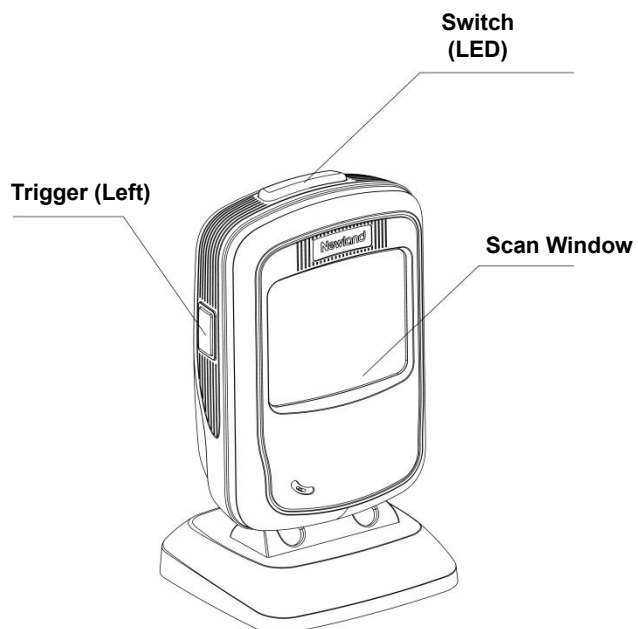

Switch:

Press it to toggle between the Screen scan mode (red LED lights up) and Sense scan mode (green LED lights up).

LED:

LED flashes once: Barcode is decoded successfully.

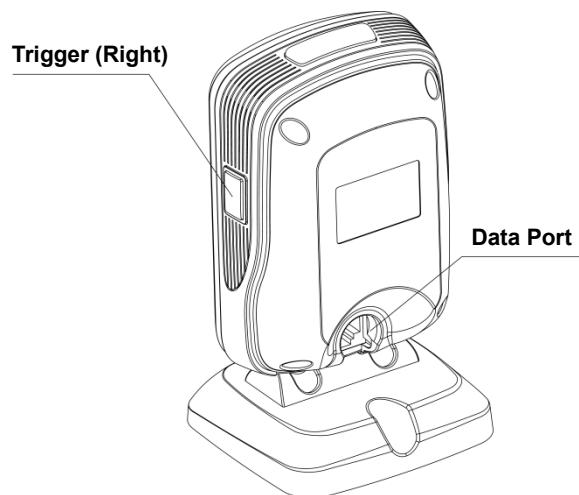

Data Port Pinout

PIN	Signal	Type	Function
1	NC	-	No connection
2	NC	-	No connection
3	VCC	P	Power+ (+5V)
4	TXD	O	RS-232 output
5	RXD	I	RS-232 input
6	CTS	I	Clear to send
7	RTS	O	Request to send
8	GND	P	Ground
9	D-	I/O	USB signal
10	D+	I/O	

Connect FR40 to a Host

The FR40 scanner must be connected to a Host in actual application, such as PC, POS or any intelligent terminal with USB or RS-232 port, via a communication cable, either USB or RS-232 cable.

USB

USB port on the Host

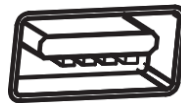

RS-232

RS-232 port on the Host



Use USB Cable

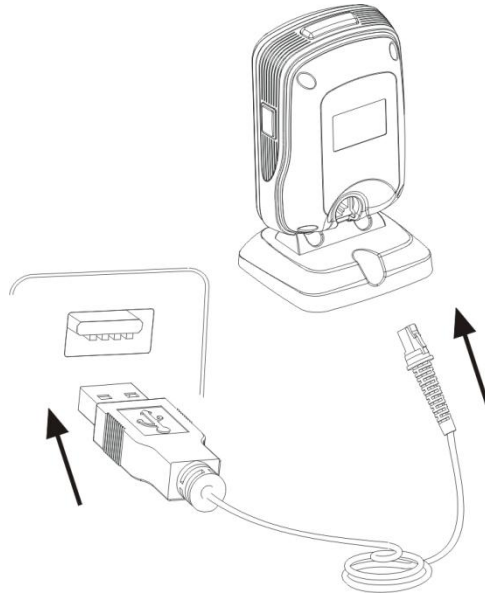

Connect the FR40 scanner to a Host through a USB cable with RJ45 and USB connectors:

1. Plug the RJ45 connector into the data port on the scanner.
2. Plug the USB connector into the USB port on the Host.

Use RS-232 Cable

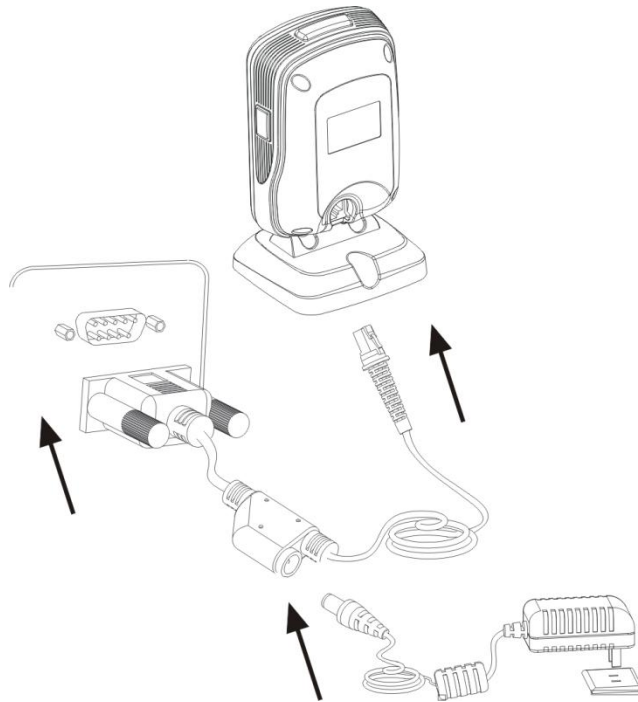

Connect the FR40 scanner to a Host through a RS-232 cable with RJ45, RS-232 and power connectors:

1. Plug the RJ45 connector into the data port on the scanner.
2. Plug the RS-232 connector into the RS-232 port on the Host.
3. Connect the supplied power adaptor to the power connector of the RS-232 cable.

Power On, Sleep, Power Off, Reboot

Power on the scanner

Connect the FR40 scanner to a Host. Then the scanner will be turned on and automatically enter the sleep mode.

Enter the sleep mode

If no operation is performed on the device for some time, the device will automatically enter the sleep state.

Power off the scanner

Remove the communication cable from the FR40 scanner; or remove the USB cable from the Host; or disconnect the power adaptor from mains.

Reboot the scanner

If the FR40 scanner stops responding to input or runs abnormally, turn off the scanner and then turn it back on.

Maintenance

- ✧ The scan window should be kept clean.
- ✧ Do not scratch the scan window.
- ✧ Use soft brush to remove the stain from the scan window.
- ✧ Use the soft cloth to clean the window, such as eyeglass cleaning cloth.
- ✧ Do not spray any liquid on the scan window.
- ✧ Do not use any detergent to clean other parts of the device except for water.



The warranty **DOES NOT** cover damages caused by inappropriate care and maintenance.

Dimensions (unit: mm)

Left View

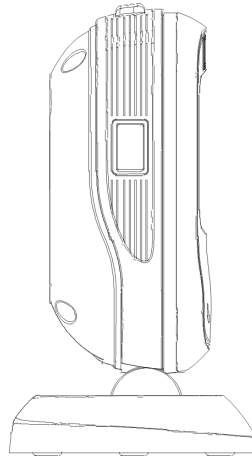

Fig. 1-6

Front View

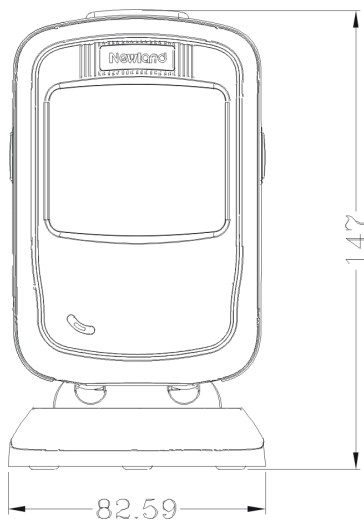

Fig. 1-7

Right View

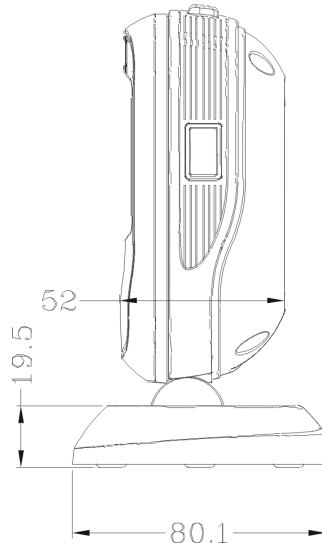

Fig. 1-8

Scanning Instructions

When the FR40 scanner is in the Sense scan mode, you can follow the steps below to scan a barcode:

- ✧ Connect the scanner to a Host with the cable. Then the scanner will be powered on.
- ✧ Present a barcode to the center of the scan window. Then the scanner will project a red beam and start to decode the barcode.
- ✧ If the barcode is decoded successfully, the scanner will emit a good read beep and the decoded data will be sent to the Host.

Chapter 2 QuickSet

QuickSet is Windows-based barcode reading software developed by Newland Auto-ID Tech. Users can use it to develop applications, troubleshoot problems and configure FR40 scanners.

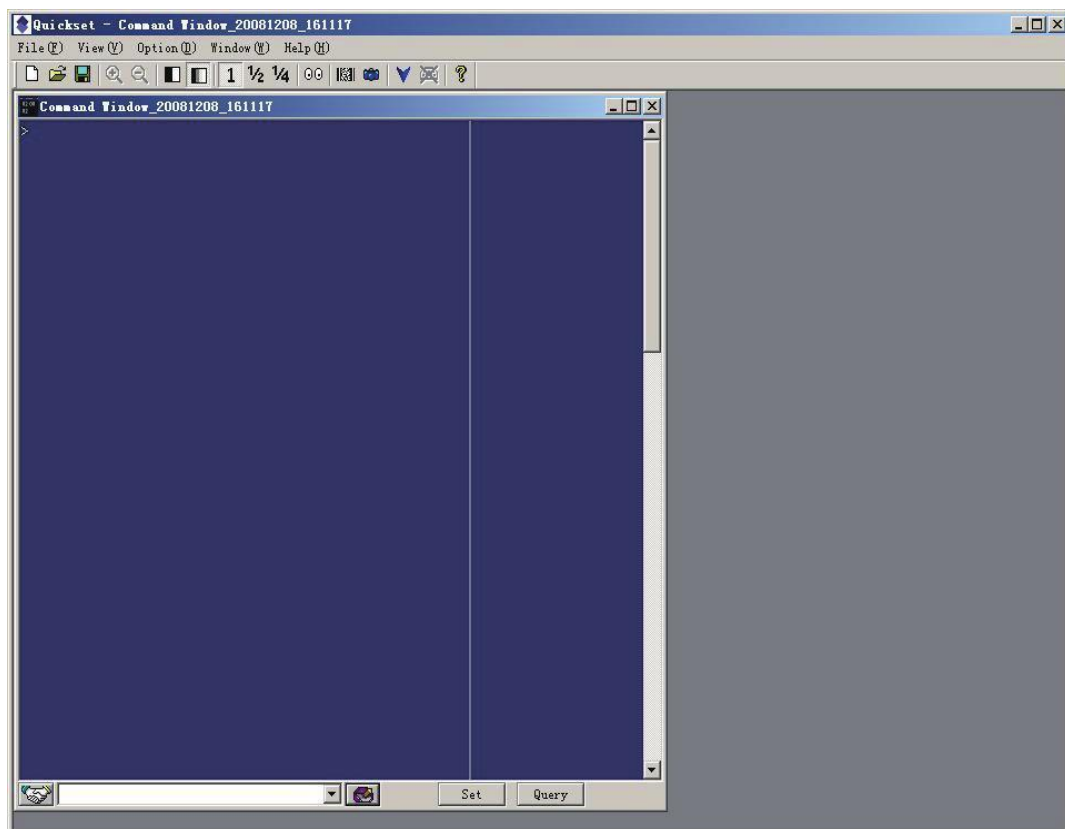

Fig. 2-1



【Enter Setup】

Chapter 3 System Settings

Introduction

There are three ways to configure the FR40 scanner: barcode programming, command programming and QuickSet programming.

Barcode Programming

The FR40 scanner can be configured through scanning programming barcodes. In the following sections, we will explain the available options and features and provide the barcodes to program them.

This programming method is most straightforward. However, it requires manually scanning barcodes. As a result, errors are more likely to occur.

Command Programming

The FR40 scanner can also be configured by command strings sent from the Host. In the following sections, the commands will be provided along with programming barcodes.

Users can also design an application to send those command strings to their scanners.

QuickSet Programming

Besides the two methods mentioned above, you can conveniently perform scanner configuration through QuickSet too. QuickSet is a Windows-based GUI program, enabling users to gain access to decoded data and captured images and to configure scanners.

This method is quite similar to the command programming. QuickSet is a software program particularly designed for Newland products.

Note: All settings except temporary ones are stored in non-volatile memory of the scanner and will not be lost by removing power from the scanner.



** 【Exit Setup】



【Enter Setup】

Programming Barcode/Command/Function



The figure above is an example that shows you the programming barcode and command for the Exit Setup function:

1. The **Exit Setup** barcode
2. The **Exit Setup** command
3. The function/feature that can be enabled by using the programming barcode or command listed above.
4. ****** indicates factory default settings.

Use of Programming Barcodes

Scanning the **Enter Setup** barcode can enable the scanner to enter the setup mode. Then you can scan a number of programming barcodes to configure your scanner. To exit the setup mode, scan the **Exit Setup** barcode.

Some functions or options may involve parameter value settings that require scanning numeric barcodes. To find the numeric barcodes, see the **Digit Barcodes** section in **Appendix**.



**** 【Exit Setup】**



【Enter Setup】

Programming barcode data can be transmitted to the Host. Scan the appropriate barcode below to enable or disable the transmission of programming barcode data (programming commands) to the Host.



**** 【Do Not Transmit Programming Barcode Data】**



【Transmit Programming Barcode Data】

Illumination

A couple of illumination options are provided to improve the lighting conditions during every image capture:

- ◇ **Mode 1:** Turn on the two red LEDs on the upper row for illumination.
- ◇ **Mode 2:** Turn on the two red LEDs on the lower row for illumination.
- ◇ **Mode 3:** Turn on all four red LEDs for illumination.



**** 【Mode 1】**



【Mode 2】



【Mode 3】

Note: It is recommended that you select Mode 3 when scanning barcodes on moving objects.



**** 【Exit Setup】**



0006010

【Enter Setup】

Beep

Good Read Beep

Scanning the **Good Read Beep Off** barcode disables the scanner's ability to beep upon a successful decode of non-programming barcode; scanning the **Good Read Beep On** barcode can enable it.

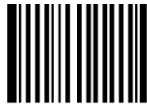

0203010

**** 【Good Read Beep On】**



0203000

【Good Read Beep Off】

Good Read Beep Type



0203020

**** 【Type 1】**



0203022

【Type 3】



0203021

【Type 2】



0006000

**** 【Exit Setup】**



0006010

【Enter Setup】

Good Read Beep Duration (Type 1)



0203050

**** 【Medium (80ms)】**

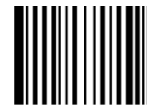

0203051

【Short (40ms)】



0203052

【Custom (20-300ms)】

Good Read Beep Frequency (Type 1)



0203060

【Extra Low (800Hz)】



0203061

【Low (1600Hz)】



0203062

**** 【Medium (2730Hz)】**



0203063

【High (4200Hz)】



0203064

【Custom (20-20000Hz)】



0006000

**** 【Exit Setup】**



0006010

【Enter Setup】

Good Read Beep Volume



0203030

**** 【Loud】**



0203032

【Low】



0203031

【Medium】

Startup Beep



0204001

**** 【Startup Beep On】**

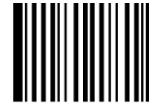

0204000

【Startup Beep Off】

Beep Definitions

Beep Sequence	Indication
4 ascending beeps	The scanner is powered up (if the Startup Beep is on).
1 beep	A non-programming barcode was decoded (if the Good Read Beep is on).
2 beeps	A programming barcode was decoded.
3 short low beeps and 2 high beeps	The scanner failed to decode a programming barcode.
1 long low beep	The scanner detected an unknown character when using USB HID-KBW (if the Beep on Unknown Character is enabled).



0006000

**** 【Exit Setup】**



【Enter Setup】

Scan Mode

- ◇ **Sense Mode:** Presenting a barcode on paper to the scan window activates a decode session. Holding down the trigger can also activate a decode session.
- ◇ **Screen Mode:** Presenting an on-screen barcode to the scan window activates a decode session.

Toggle between the Sense and Screen scan modes:

Method 1: Press the button (Switch) at the top of the scanner.

Method 2: Scan the **Screen Mode** barcode to activate the Screen scan mode (indicated by red LED); scan the **Motion Mode** barcode to activate the Sense scan mode (indicated by green LED).



** **【Motion Mode】**



【Screen Mode】

Enable/Disable the Switch

You may enable or disable the Switch at the top of the scanner by scanning the appropriate barcode below.



** **【Enable the Switch】**



【Disable the Switch】



** **【Exit Setup】**



0006010

【Enter Setup】

Auto Sleep

Auto Sleep allows the scanner to automatically enter the sleep mode after 3 seconds of inactivity. When the scanner is in the sleep mode, presenting a barcode to it or sending a command to it can awake it.



0008020

**** 【Enable Auto Sleep】**



0008010

【Disable Auto Sleep】



0006000

**** 【Exit Setup】**



0006010
【Enter Setup】

Decode Area

Whole Area Decoding

The scanner attempts to decode barcode(s) within its field of view and transmits the barcode that has been first decoded.

Central Area Decoding

The scanner attempts to decode barcode(s) within a specified central area and transmits the barcode that has been first decoded. This feature allows the scanner to narrow its field of view to make sure the scanner reads only those barcodes intended by the user. For instance, if multiple barcodes are placed closely together, central area decoding will insure that only the desired barcode is read.

Specify Central Area

The default central area is a (Width*20%) by (Height*20%) area in the center of the scanner's field of view, as shown in the figure below. You can define the central area by scanning the **Specify Central Area** barcode and numeric barcode(s) corresponding to a desired percentage (1-100). If Central Area Decoding is enabled by scanning the **Central Area Decoding** barcode, the scanner only reads barcodes that intersect the predefined central area.

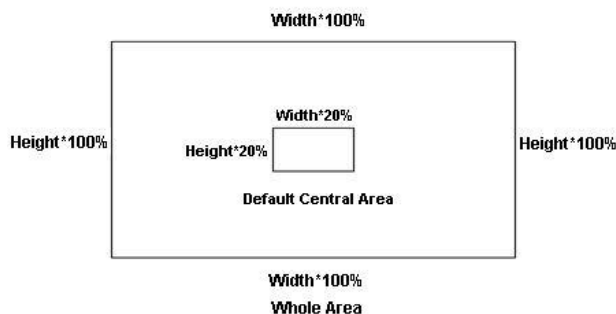

** 【Whole Area Decoding】



【Central Area Decoding】



【Specify Central Area】



0006000
** 【Exit Setup】



【Enter Setup】

Default Settings

Factory Defaults

Scanning the following barcode can restore the scanner to the factory defaults.

You may need to reset all parameters to the factory defaults when:

- ◇ scanner is not properly configured so that it fails to decode barcodes.
- ◇ you forget previous configuration and want to avoid its impact.



**** 【Restore All Factory Defaults】**

Custom Defaults

Custom defaults make it possible to save the frequently-used settings on the scanner.

Scanning the **Save as Custom Defaults** barcode can save the current settings as custom defaults. Once custom default settings are stored, they can be recovered at any time by scanning the **Restore All Custom Defaults** barcode.

Custom defaults are stored in the non-volatile memory.



【Save as Custom Defaults】



【Restore All Custom Defaults】



Restoring the scanner to the factory defaults will not remove the custom defaults from the scanner.



**** 【Exit Setup】**



【Enter Setup】

Product Information

- ◇ **Obtain Product Information:** Transmit the product information to the Host straight away.
- ◇ **Send Product Information at Startup:** Transmit the product information to the Host when the scanner is powered on. This feature only applies to scanners using an RS-232 interface.



【Obtain Product Information】



**** 【Do Not Send Product Information at Startup】**



【Send Product Information at Startup】



**** 【Exit Setup】**



【Enter Setup】

Details of product information are described in the table below:

Item	Description
Firmware Ver	Firmware Version
Build Time	Firmware Build Time
Device ID	Device Type
App Ver	Application Version
uIMG Ver	uIMG Version
Date	Manufacture Date
S/N	Factory Serial Number
ESN	User-defined Serial Number
Manufacture ID	Device Name
Interface	1. RS-232, baud rate, parity check, data bit, stop bit. 2. USB, type of USB interface.
1D	Indicate reading 1D is allowed. Enabled symbologies are separated by a comma. Additional information includes: 1. — ? is followed by the additional feature of the symbology. 2. Minimum length -> maximum length 3. — N Check Digit" or — C heck Digit" 4. — Fixed Length": i.e. discrete length, even number(s) between 2 and 64.
2D	Indicate reading 2D is allowed. Enabled symbologies are separated by a comma. Additional information includes: minimum length -> maximum length
MCU Mode (Scanning Preference)	1. Sense 2. Motion
Scan Mode	1. Sense Scan 2. Screen Scan



****【Exit Setup】**



【Enter Setup】

Chapter 4 RS-232 Interface

Introduction

When the scanner is connected to the RS-232 port of a Host, the scanner will select **RS-232 Connection** by default. However, you need to set communication parameters (including baud rate, parity check, data bit and stop bit) to match the Host.

The **RS-232 Connection** barcode is used when the scanner is connected to the RS-232 port of a Host.



【RS-232 Connection】

RS-232 Parameters

When the scanner is connected to the Host via serial port, it is necessary to maintain consistency in communication parameters configuration on both devices to ensure smooth communication between them.



**** 【Exit Setup】**



0006010

【Enter Setup】

Baud Rate

Baud rate is the number of bits of data transmitted per second. Set the baud rate to match the Host requirements. The default baud rate is 9600 bps.



0100030

**** 【Baud Rate 9600】**



0100050

【Baud Rate 19200】



0100000

【Baud Rate 1200】

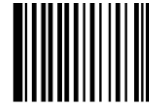

0100060

【Baud Rate 38400】



0100010

【Baud Rate 2400】



0100070

【Baud Rate 57600】

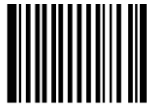

0100020

【Baud Rate 4800】

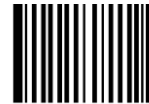

0100080

【Baud Rate 115200】



0100040

【Baud Rate 14400】



0006000

**** 【Exit Setup】**



【Enter Setup】

Parity Check

Set the parity type to match the Host requirements. The default setting is No Parity.

- ◇ **Odd Parity:** If the data contains an odd number of 1 bits, the parity bit value is set to 0.
- ◇ **Even Parity:** If the data contains an even number of 1 bits, the parity bit value is set to 0.
- ◇ **None:** Select this option when no parity bit is required.



**** 【None】**



【Odd Parity】



【Even Parity】



**** 【Exit Setup】**



0006010

【Enter Setup】

Data Bit

Set the number of data bits to match the Host requirements. The default setting is 8 Data Bits.



0103030

**** 【8 Data Bits】**



0103010

【6 Data Bits】



0103020

【7 Data Bits】



0103000

【5 Data Bits】

Stop Bit

The stop bit(s) at the end of each transmitted character marks the end of transmission of one character and prepares the receiving device for the next character in the serial data stream. Set the number of stop bits to match the Host requirements. The default setting is 1 Stop Bit.



0102000

**** 【1 Stop Bit】**



0102010

【2 Stop Bits】



0006000

**** 【Exit Setup】**



0006010

【Enter Setup】

Hardware Auto Flow Control

If this feature is enabled, the scanner determines whether to transmit data based on CTS signal level. When CTS signal is at a low level which means the serial port's cache memory of receiving device (such as PC) is full, the scanner sends data through RS-232 port until CTS signal is set to high level by receiving device. When the scanner is not ready for receiving, it will set RTS signal to low level. When sending device (such as PC) detects it, it will not send data to the scanner any more to prevent data loss.

If this feature is disabled, reception/transmission of serial data will not be influenced by RTS/CTS signal.



0104000

**** 【Disable Hardware Auto Flow Control】**



0104010

【Enable Hardware Auto Flow Control】



Before enabling this feature, make sure that RTS/CTS signal line is contained in RS-232 cable. Without the signal line, RS-232 communication errors will occur.



0006000

**** 【Exit Setup】**



0006010

【Enter Setup】

Chapter 5 USB Interface

Introduction

There are four options for USB connection.

- ◇ USB HID-KBW: The scanner's transmission is simulated as USB keyboard input with no need for command configuration or a driver. The barcode data could be entered by the virtual keyboard directly and it is also convenient for the Host to receive data.
- ◇ USB DataPipe: USB DataPipe is a transport protocol developed by Newland Auto-ID Tech, which requires installation of a specific driver on the Host. It supports data transmission and device configuration on QuickSet. The DataPipe driver for Windows is available at <http://www.nlscan.com>.
- ◇ USB COM Port Emulation: The USB port on the Host is emulated as a RS-232 port with the same data transmission and configuration as a real RS-232 port. This mode is based on USB DataPipe protocol and requires the USB DataPipe driver, too.
- ◇ HID-POS: It is based on the HID interface, with no need of a custom driver. It excels virtual keyboard and traditional RS-232 interface in transmission speed.

When the scanner is connected to both USB and RS-232 ports on a Host, it will select the USB connection by default.

USB Suspend

This feature allows the scanner to suspend its USB interface to conserve power when PC goes into sleep or hibernate mode.



0008040

**** 【Enable USB Suspend】**



0008030

【Disable USB Suspend】



0006000

**** 【Exit Setup】**



【Enter Setup】

USB HID-KBW

When the scanner is connected to the USB port on a Host, you can enable the USB HID-KBW feature by scanning the barcode below. Then scanner's transmission will be simulated as USB keyboard input. The Host receives keystrokes on the virtual keyboard. It works on a Plug and Play basis and no driver is required.



【USB HID-KBW】



If the Host allows keyboard input, then no extra software is needed for HID-KBW input.

Fast Mode

When **Fast Mode On** is selected, the engine sends characters to the Host faster. If the Host drops characters, do not use Fast Mode.



**** 【Fast Mode Off】**



【Fast Mode On】



**** 【Exit Setup】**



0006010

【Enter Setup】

USB HID-KBW Speed

This parameter specifies the USB poll rate for a USB keyboard. If the Host drops characters, change the poll rate to a bigger value.



1103170

【1ms】



1103171

【2ms】



1103172

【3ms】



1103173

**** 【4ms】**



1103174

【5ms】



1103175

【6ms】



1103176

【7ms】



1103177

【8ms】



1103178

【9ms】



1103179

【10ms】



0006000

**** 【Exit Setup】**



【 Enter Setup 】

USB Country Keyboard Types

Keyboard layouts and country codes vary from country to country. The default setting is US keyboard type. Follow the steps below to program the keyboard type for your country or language.

1. Scan the **Enter Setup** barcode.
2. Scan the **Select Country Code** barcode.
3. Scan the code of your country. (See the “Country Code Table”)
4. Scan the **Save** barcode.
5. Scan the **Exit Setup** barcode.



【 Select Country Code 】

E
sample

Program the scanner to emulate Norwegian keyboard (Norway):

1. Scan the **Enter Setup** barcode.
2. Scan the **Select Country Code** barcode.
3. Scan the numeric barcodes “1” and “5”. (See the “Digit Barcodes” section in **Appendix**)
4. Scan the **Save** barcode. (See the “Save/Cancel Barcodes” section in **Appendix**)
5. Scan the **Exit Setup** barcode.



**** 【 Exit Setup 】**



0006010

【Enter Setup】

Country Code Table

Country/Language	Code	Country/Language	Code
US	0	Netherlands (Dutch)	14
Belgium	1	Norway	15
Brazil	2	Poland	16
Canada (French)	3	Portugal	17
Czechoslovakia	4	Romania	18
Denmark	5	Russia	19
Finland (Swedish)	6	Slovakia	21
France	7	Spain	22
Germany/Austria	8	Sweden	23
Greece	9	Switzerland (German)	24
Hungary	10	Turkey F	25
Israel (Hebrew)	11	Turkey Q	26
Italy	12	UK	27
Latin-American	13	Japan	28



0006000

****【Exit Setup】**



【Enter Setup】

Beep on Unknown Character

Due to the differences in keyboard layouts, some characters contained in barcode data may be unavailable on the selected keyboard. As a result, the scanner fails to transmit the unknown characters.

Scan the appropriate barcode below to enable or disable the emission of beep when an unknown character is detected.



** 【Do Not Beep on Unknown Character】



【Beep on Unknown Character】

E
sample

Supposing French keyboard (Country Code: 7) is selected and barcode data "ADF" is being dealt with, the keyboard will fail to locate the "Ð" (0xD0) character and the scanner will ignore the character and continue to process the next one.

Do Not Beep on Unknown Character: The scanner does not beep and the Host receives "AF".

Beep on Unknown Character: The scanner beeps and the Host still receives —AF.



If **Emulate ALT+Keypad ON** is selected, **Beep on Unknown Character** does not function.



** 【Exit Setup】



【Enter Setup】

Emulate ALT+Keypad

When Emulate ALT+Keypad is turned on, any ASCII character (0x00 - 0xff) is sent over the numeric keypad no matter which keyboard type is selected.

1. ALT Make
2. Enter the number corresponding to a desired character on the keypad.
3. ALT Break



**** 【Emulate ALT+Keypad OFF】**



【Emulate ALT+Keypad ON】



Since sending a character involves multiple keystroke emulations, this method appears less efficient.



Supposing French keyboard (Country Code: 7) is selected and **Emulate ALT+Keypad** is ON, barcode data "ADF" (65/208/70) is sent as below:

"A" -- —ALT Make" + —65" + —ALT Break"

"D" -- —ALT Make" + —08" + —ALT Break"

"F" -- —ALT Make" + —70" + —ALT Break"



**** 【Exit Setup】**



【Enter Setup】

Function Key Mapping

When Function Key Mapping is enabled, function character (0x00 - 0x1F) are sent as ASCII sequences over the numeric keypad.

1. CTRL Make
2. Press function key
3. CTRL Break



** 【Disable Function Key Mapping】



【Enable Function Key Mapping】

E
sample

Supposing the **Function Key Mapping** feature is enabled and other parameters of USB HID-KBW adopt factory defaults, barcode data —AHT>(i.e. Horizontal Tab)F” (0x41/0x09/0x46) is sent as below:

1. “A” - Keystroke “A”.
2. —Ctrl” - —CtrlMake” + Keystroke —|+ —CtrlBreak”
3. -F” - Keystroke —F

For some text editors, —Ctrl” means italic convert. So the output may be —*A*”.



Emulate ALT+Keypad ON prevails over **Enable Function Key Mapping**.



** 【Exit Setup】



【Enter Setup】

ASCII Function Key Mapping Table

ASCII Function	ASCII Value (HEX)	No Function Key Mapping	Function Key Mapping
NUL	00	Null	Ctrl+2
SOH	01	Keypad Enter	Ctrl+A
STX	02	Caps Lock	Ctrl+B
ETX	03	Null	Ctrl+C
EOT	04	Null	Ctrl+D
ENQ	05	Null	Ctrl+E
ACK	06	Null	Ctrl+F
BEL	07	Enter	Ctrl+G
BS	08	Left Arrow	Ctrl+H
HT	09	Horizontal Tab	Ctrl+I
LF	0A	Down Arrow	Ctrl+J
VT	0B	Vertical Tab	Ctrl+K
FF	0C	Delete	Ctrl+L
CR	0D	Enter	Ctrl+M
SO	0E	Insert	Ctrl+N
SI	0F	Esc	Ctrl+O
DLE	10	F11	Ctrl+P
DC1	11	Home	Ctrl+Q
DC2	12	Print Screen	Ctrl+R
DC3	13	Backspace	Ctrl+S
DC4	14	tab+shift	Ctrl+T
NAK	15	F12	Ctrl+U
SYN	16	F1	Ctrl+V
ETB	17	F2	Ctrl+W
CAN	18	F3	Ctrl+X
EM	19	F4	Ctrl+Y
SUB	1A	F5	Ctrl+Z
ESC	11	F6	Ctrl+[
FS	1C	F7	Ctrl+\
GS	1D	F8	Ctrl+]
RS	1E	F9	Ctrl+6
US	1F	F10	Ctrl+-



****【Exit Setup】**



0006010
【Enter Setup】

ASCII Function Key Mapping Table (Continued)

The last five characters (0x1B~0x1F) in the table above apply to US keyboard layout only. The following chart provides the equivalents of these five characters for other countries.

Country	Code					
United	[\]	6	-	
Belgium	[<]	6	-	
Scandinavia	8	<	9	6	-	
France	^	8	\$	6	=	
Germany		Ã	+	6	-	
Italy		\	+	6	-	
Switzerland		<	..	6	-	
United Kingdom	[ç]	6	-	
Denmark	8	\	9	6	-	
Norway	8	\	9	6	-	
Spain	[\]	6	-	



0006000
** 【Exit Setup】



0006010

【Enter Setup】

Inter-Keystroke Delay

This parameter specifies the delay between emulated keystrokes.



1103050

**** 【No Delay】**



1103052

【Long Delay (40ms)】



1103051

【Short Delay (20ms)】



0006000

**** 【Exit Setup】**



【Enter Setup】

Caps Lock

The **Caps Lock ON** option can invert upper and lower case characters contained in barcode data. This inversion occurs regardless of the state of Caps Lock key on the Host's keyboard.



**** 【Caps Lock OFF】**



【Caps Lock ON】



Emulate ALT+Keypad ON/ Convert All to Upper Case/ Convert All to Lower Case prevails over Caps Lock ON.

E
xample

When the **Caps Lock ON** is selected, barcode data —**A6**” is transmitted as **aBc**”.



**** 【Exit Setup】**



【Enter Setup】

Convert Case

Scan the appropriate barcode below to convert all barcode data to your desired case.



**** 【No Case Conversion】**



【Convert All to Lower Case】



【Convert All to Upper Case】

E
xample

When the **Convert All to Lower Case** feature is enabled, barcode data —**AG**” is transmitted as **-abc**”.



If **Emulate ALT+Keypad ON** is selected, **Convert All to Lower Case** and **Convert All to Upper Case** do not function.



**** 【Exit Setup】**



【 Enter Setup 】

Emulate Numeric Keypad



When this feature is disabled, sending barcode data is emulated as keystroke(s) on main keyboard.

To enable this feature, scan the **Emulate Numeric Keypad** barcode. Sending a number (0-9) is emulated as keystroke(s) on numeric keypad, whereas sending other character like →, ←, *, / and . is still emulated as keystrokes on main keyboard.

Numeric keypad is usually situated at the right of the main keyboard. The state of Num Lock on the simulated numeric keypad is determined by its equivalent on the Host. If Num Lock on the Host is turned off, the output of simulated numeric keypad is function key instead of number.



**** 【 Do Not Emulate Numeric Keypad 】**



【 Emulate Numeric Keypad 】



Make sure the Num Lock light of the Host is turned ON before enabling this feature.

Emulate ALT+Keypad ON prevails over **Emulate Numeric Keypad**.



**** 【 Exit Setup 】**



0006010

【Enter Setup】

E *Example*

Supposing the **Emulate Numeric Keypad** feature is enabled:

if Num Lock on the Host is ON, —A5” is transmitted as —A.5”;

if Num Lock on the Host is OFF, —A5” is transmitted as follows:

1. “A” is sent as is because it is not included in numeric keypad;
2. -4” is sent as the function key —Cursor Move to Left”;
3. →” is sent as the function key —Delete After the Cursor”;
4. -5” is not sent as it does not correspond to any function key.



0006000

** 【Exit Setup】



【Enter Setup】

USB DataPipe

This protocol is defined by Newland. A driver is required when using this protocol to communicate with scanner.

Its advantages include fast data transmission and easy integration of the SDK into application system.



【USB DataPipe】



**** 【Exit Setup】**



【Enter Setup】

USB COM Port Emulation

If your scanner is connected to the USB port on a Host, the USB COM Port Emulation feature allows the Host to receive data in the way as a serial port does. However, you need to set communication parameters on the scanner to match the Host requirements. To learn how to program communication parameters, see the “**RS-232 Parameters**” section in Chapter 4.



【USB COM Port Emulation】

USB HID-POS

Introduction

The USB HID-POS interface is recommended for new application programs. It can send up to 56 characters in a single USB report and appears more efficient than keyboard emulation.

Features:

- ◇ HID based, no custom driver required.
- ◇ Way more efficient in communication than keyboard emulation and traditional RS-232 interface.

Note: HID-POS does not require a custom driver. However, a HID interface on Windows 98 does. All HID interfaces employ standard driver provided by the operating system. Use defaults when installing the driver.



【HID-POS】



****【Exit Setup】**



【 Enter Setup 】

Access the Scanner with Your Program

Use CreateFile to access the scanner as a HID device and then use ReadFile to deliver the scanned data to the application program. Use WriteFile to send data to the scanner.

For detailed information about USB and HID interfaces, go to www.USB.org.

Acquire Scanned Data

After a barcode is decoded, the scanner sends an input report as below:

	Bit							
Byte	7	6	5	4	3	2	1	0
0	Report ID = 0x02							
1	Barcode Length							
2-57	Decoded Data (1-56)							
58-61	Reserved (1-4)							
62	Newland Symbology Identifier or N/C: 0x00							
63	-	-	-	-	-	-	-	Decode Data Continued

VID/PID

USB uses VID (Vendor ID) and PID (Product ID) to identify and locate a device. The VID is assigned by USB Implementers Forum. Newland's vendor ID is 1EAB (Hex). A range of PIDs are used for each Newland product family. Every PID contains a base number and interface type (keyboard, COM port, etc.).

Product	Interface	PID (Hex)	PID (Dec)
FR40	Base	0000	0
	HID POS	0010	16



**** 【 Exit Setup 】**



【Enter Setup】

Chapter 6 Symbologies

Introduction

Every symbology (barcode type) has its own unique attributes. This chapter provides programming barcodes for configuring the scanner so that it can identify various barcode symbologies. The more symbologies you enable, the slower your scanner decodes. It is recommended to disable those that are rarely used to improve the performance of the scanner.

General Settings

Disable All Symbologies

If the **Disable All Symbologies** feature is enabled, the scanner can only identify the programming barcodes.



【Disable All Symbologies】

Enable All Symbologies

If the **Enable All Symbologies** feature is enabled, the scanner will be able to read all compatible barcode symbologies as well as the programming barcodes.



【Enable All Symbologies】



****【Exit Setup】**



【Enter Setup】

Enable 1D Symbologies



【Enable 1D Symbologies】

Disable 1D Symbologies



【Disable 1D Symbologies】

Enable 2D Symbologies



【Enable 2D Symbologies】

Disable 2D Symbologies



【Disable 2D Symbologies】



****【Exit Setup】**



0006010

【Enter Setup】

1D Twin Code

1D twin code is two 1D barcodes of a symbology or of different symbologies paralleled vertically. Both barcodes must have similar specifications and be placed closely together.

There are 3 options for reading 1D twin code:

- ◇ **Single 1D Code Only:** Read either 1D code.
- ◇ **Twin 1D Code Only:** Read both 1D codes. Transmission sequence: upper 1D code followed by lower 1D code.
- ◇ **Both Single & Twin:** Read both 1D codes. If successful, transmit as twin 1D code only. Otherwise, try single 1D code only.



0001070

**** 【Single 1D Code Only】**



0001080

【Both Single & Twin】



0001090

【Twin 1D Code Only】



0006000

**** 【Exit Setup】**



【Enter Setup】

Code 128

Restore Factory Defaults



**** 【Restore the Factory Defaults of Code 128】**

Enable/Disable Code 128



**** 【Enable Code 128】**



【Disable Code 128】



If the scanner fails to identify Code 128 barcodes, you may first try this solution by scanning the **Enter Setup** barcode and then **Enable Code 128** barcode.



**** 【Exit Setup】**



【Enter Setup】

Set Length Range for Code 128

The scanner can be configured to only decode Code 128 barcodes with lengths that fall between (inclusive) the minimum and maximum lengths. To accomplish it, you need to set the minimum and maximum lengths.



【Set the Minimum Length (Default: 1)】



【Set the Maximum Length (Default: 48)】



If minimum length is set to be greater than maximum length, the scanner only decodes Code 128 barcodes with either the minimum or maximum length. If minimum length is same as maximum length, only Code 128 barcodes with that length are to be decoded.



Set the scanner to decode Code 128 barcodes containing between 8 and 12 characters:

1. Scan the **Enter Setup** barcode.
2. Scan the **Set the Minimum Length** barcode.
3. Scan the numeric barcode —8 (See the **-Digit Barcodes**” section in **Appendix**)
4. Scan the **Save** barcode. (See the **-Save/Cancel Barcodes**” section in **Appendix**)
5. Scan the **Set the Maximum Length** barcode.
6. Scan the numeric barcode —1
7. Scan the numeric barcode —2
8. Scan the **Save** barcode.
9. Scan the **Exit Setup** barcode.



****【Exit Setup】**



【Enter Setup】

EAN-8

Restore Factory Defaults



**** 【Restore the Factory Defaults of EAN-8】**

Enable/Disable EAN-8



**** 【Enable EAN-8】**



【Disable EAN-8】



If the scanner fails to identify EAN-8 barcodes, you may first try this solution by scanning the **Enter Setup** barcode and then **Enable EAN-8** barcode.



**** 【Exit Setup】**



【Enter Setup】

Transmit Check Digit

EAN-8 is 8 digits in length with the last one as its check digit used to verify the integrity of the data.



**** 【Transmit EAN-8 Check Digit】**



【Do Not Transmit EAN-8 Check Digit】

2-Digit Add-On Code

An EAN-8 barcode can be augmented with a two-digit add-on code to form a new one. In the example below, the part surrounded by blue dotted line is an EAN-8 barcode while the part circled by red dotted line is a two-digit add-on code.



**** 【Disable 2-Digit Add-On Code】**



【Enable 2-Digit Add-On Code】



Disable 2-Digit Add-On Code: The scanner decodes EAN-8 and ignores the add-on code when presented with an EAN-8 plus 2-digit add-on barcode. It can also decode EAN-8 barcodes without 2-digit add-on codes.

Enable 2-Digit Add-On Code: The scanner decodes a mix of EAN-8 barcodes with and without 2-digit add-on codes.



**** 【Exit Setup】**



【Enter Setup】

5-Digit Add-On Code

An EAN-8 barcode can be augmented with a five-digit add-on code to form a new one. In the example below, the part surrounded by blue dotted line is an EAN-8 barcode while the part circled by red dotted line is a five-digit add-on code.



**** 【Disable 5-Digit Add-On Code】**



【Enable 5-Digit Add-On Code】



Disable 5-Digit Add-On Code: The scanner decodes EAN-8 and ignores the add-on code when presented with an EAN-8 plus 5-digit add-on barcode. It can also decode EAN-8 barcodes without 5-digit add-on codes.

Enable 5-Digit Add-On Code: The scanner decodes a mix of EAN-8 barcodes with and without 5-digit add-on codes.

EAN-8 Extension

- ◇ **Disable EAN-8 Zero Extend:** Transmit EAN-8 barcodes as is.
- ◇ **Enable EAN-8 Zero Extend:** Add five leading zeros to decoded EAN-8 barcodes to extend to 13 digits.



**** 【Disable EAN-8 Zero Extend】**



【Enable EAN-8 Zero Extend】



**** 【Exit Setup】**



0006010

【Enter Setup】

EAN-13

Restore Factory Defaults

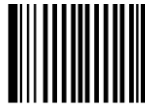

0402000

**** 【Restore the Factory Defaults of EAN-13】**

Enable/Disable EAN-13



0402020

**** 【Enable EAN-13】**

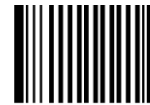

0402010

【Disable EAN-13】



If the scanner fails to identify EAN-13 barcodes, you may first try this solution by scanning the **Enter Setup** barcode and then **Enable EAN-13** barcode.



0006000

**** 【Exit Setup】**



【Enter Setup】

Transmit Check Digit



**** 【Transmit EAN-13 Check Digit】**



【Do Not Transmit EAN-13 Check Digit】

2-Digit Add-On Code

An EAN-13 barcode can be augmented with a two-digit add-on code to form a new one. In the example below, the part surrounded by blue dotted line is an EAN-13 barcode while the part circled by red dotted line is a two-digit add-on code.



**** 【Disable 2-Digit Add-On Code】**



【Enable 2-Digit Add-On Code】



Disable 2-Digit Add-On Code: The scanner decodes EAN-13 and ignores the add-on code when presented with an EAN-13 plus 2-digit add-on barcode. It can also decode EAN-13 barcodes without 2-digit add-on codes.

Enable 2-Digit Add-On Code: The scanner decodes a mix of EAN-13 barcodes with and without 2-digit add-on codes.



**** 【Exit Setup】**



【Enter Setup】

5-Digit Add-On Code

An EAN-13 barcode can be augmented with a five-digit add-on code to form a new one. In the example below, the part surrounded by blue dotted line is an EAN-13 barcode while the part circled by red dotted line is a five-digit add-on code.



**** 【Disable 5-Digit Add-On Code】**



【Enable 5-Digit Add-On Code】



Disable 5-Digit Add-On Code: The scanner decodes EAN-13 and ignores the add-on code when presented with an EAN-13 plus 5-digit add-on barcode. It can also decode EAN-13 barcodes without 5-digit add-on codes.

Enable 5-Digit Add-On Code: The scanner decodes a mix of EAN-13 barcodes with and without 5-digit add-on codes.



**** 【Exit Setup】**



【 Enter Setup 】

UPC-E

Restore Factory Defaults



**** 【 Restore the Factory Defaults of UPC-E 】**

Enable/Disable UPC-E



**** 【 Enable UPC-E 】**



【 Disable UPC-E 】



If the scanner fails to identify UPC-E barcodes, you may first try this solution by scanning the **Enter Setup** barcode and then **Enable UPC-E** barcode.



**** 【 Exit Setup 】**



【Enter Setup】

Transmit Check Digit

UPC-E is 8 digits in length with the last one as its check digit used to verify the integrity of the data.



**** 【Transmit UPC-E Check Digit】**



【Do Not Transmit UPC-E Check Digit】

2-Digit Add-On Code

A UPC-E barcode can be augmented with a two-digit add-on code to form a new one. In the example below, the part surrounded by blue dotted line is a UPC-E barcode while the part circled by red dotted line is a two-digit add-on code.



**** 【Disable 2-Digit Add-On Code】**



【Enable 2-Digit Add-On Code】



Disable 2-Digit Add-On Code: The scanner decodes UPC-E and ignores the add-on code when presented with a UPC-E plus 2-digit add-on barcode. It can also decode UPC-E barcodes without 2-digit add-on codes.

Enable 2-Digit Add-On Code: The scanner decodes a mix of UPC-E barcodes with and without 2-digit add-on codes.



**** 【Exit Setup】**



【 Enter Setup 】

5-Digit Add-On Code

A UPC-E barcode can be augmented with a five-digit add-on code to form a new one. In the example below, the part surrounded by blue dotted line is a UPC-E barcode while the part circled by red dotted line is a five-digit add-on code.



**** 【 Disable 5-Digit Add-On Code 】**



【 Enable 5-Digit Add-On Code 】



Disable 5-Digit Add-On Code: The scanner decodes UPC-E and ignores the add-on code when presented with a UPC-E plus 5-digit add-on barcode. It can also decode UPC-E barcodes without 5-digit add-on codes.

Enable 5-Digit Add-On Code: The scanner decodes a mix of UPC-E barcodes with and without 5-digit add-on codes.



**** 【 Exit Setup 】**



0006010

【Enter Setup】

Transmit System Character “0”

The first character of UPC-E barcode is the system character —0



0403090

**** 【Do Not Transmit System Character “0”】**



0403100

【Transmit System Character “0”】

UPC-E Extension

- ◇ **Disable UPC-E Extend:** Transmit UPC-E barcodes as is.
- ◇ **Enable UPC-E Extend”:** Extend UPC-E barcodes to make them compatible in length to UPC-A.



0403110

**** 【Disable UPC-E Extend】**



0403120

【Enable UPC-E Extend】



0006000

**** 【Exit Setup】**



【Enter Setup】

UPC-A

Restore Factory Defaults



**** 【Restore the Factory Defaults of UPC-A】**

Enable/Disable UPC-A



**** 【Enable UPC-A】**



【Disable UPC-A】



If the scanner fails to identify UPC-A barcodes, you may first try this solution by scanning the **Enter Setup** barcode and then **Enable UPC-A** barcode.



**** 【Exit Setup】**



【Enter Setup】

Transmit Check Digit

UPC-A is 12 digits in length with the last one as its check digit used to verify the integrity of the data.



**** 【Transmit UPC-A Check Digit】**



【Do Not Transmit UPC-A Check Digit】

2-Digit Add-On Code

A UPC-A barcode can be augmented with a two-digit add-on code to form a new one. In the example below, the part surrounded by blue dotted line is a UPC-A barcode while the part circled by red dotted line is a two-digit add-on code.



**** 【Disable 2-Digit Add-On Code】**



【Enable 2-Digit Add-On Code】



Disable 2-Digit Add-On Code: The scanner decodes UPC-A and ignores the add-on code when presented with a UPC-A plus 2-digit add-on barcode. It can also decode UPC-A barcodes without 2-digit add-on codes.

Enable 2-Digit Add-On Code: The scanner decodes a mix of UPC-A barcodes with and without 2-digit add-on codes.



**** 【Exit Setup】**



【Enter Setup】

5-Digit Add-On Code

A UPC-A barcode can be augmented with a five-digit add-on code to form a new one. In the example below, the part surrounded by blue dotted line is a UPC-A barcode while the part circled by red dotted line is a five-digit add-on code.



**** 【Disable 5-Digit Add-On Code】**



【Enable 5-Digit Add-On Code】



Disable 5-Digit Add-On Code: The scanner decodes UPC-A and ignores the add-on code when presented with a UPC-A plus 5-digit add-on barcode. It can also decode UPC-A barcodes without 5-digit add-on codes.

Enable 5-Digit Add-On Code: The scanner decodes a mix of UPC-A barcodes with and without 5-digit add-on codes.



**** 【Exit Setup】**



0006010

【Enter Setup】

Transmit Preamble Character “0”

The preamble character —0 is part of the UPC-A barcode.



0404090

**** 【Do Not Transmit Preamble Character “0”】**



0404100

【Transmit Preamble Character “0”】



The preamble character —0 usually does not appear in printed UPC-A barcodes.



0006000

**** 【Exit Setup】**



【Enter Setup】

Interleaved 2 of 5

Restore Factory Defaults



**** 【Restore the Factory Defaults of Interleaved 2 of 5】**

Enable/Disable Interleaved 2 of 5



**** 【Enable Interleaved 2 of 5】**



【Disable Interleaved 2 of 5】



If the scanner fails to identify Interleaved 2 of 5 barcodes, you may first try this solution by scanning the **Enter Setup** barcode and then **Enable Interleaved 2 of 5** barcode.



**** 【Exit Setup】**



【Enter Setup】

Set Length Range for Interleaved 2 of 5

The scanner can be configured to only decode Interleaved 2 of 5 barcodes with lengths that fall between (inclusive) the minimum and maximum lengths. To accomplish it, you need to set the minimum and maximum lengths.



【Set the Minimum Length (Default: 6)】



【Set the Maximum Length (Default: 80)】



If minimum length is set to be greater than maximum length, the scanner only decodes Interleaved 2 of 5 barcodes with either the minimum or maximum length. If minimum length is same as maximum length, only Interleaved 2 of 5 barcodes with that length are to be decoded.



Set the scanner to decode Interleaved 2 of 5 barcodes containing between 8 and 12 characters:

1. Scan the **Enter Setup** barcode.
2. Scan the **Set the Minimum Length** barcode.
3. Scan the numeric barcode —8 (See the **“Digit Barcodes”** section in **Appendix**)
4. Scan the **Save** barcode. (See the **“Save/Cancel Barcodes”** section in **Appendix**)
5. Scan the **Set the Maximum Length** barcode.
6. Scan the numeric barcode —1
7. Scan the numeric barcode —2
8. Scan the **Save** barcode.
9. Scan the **Exit Setup** barcode.



****【Exit Setup】**



【Enter Setup】

Check Digit Verification

A check digit is optional for Interleaved 2 of 5 and can be added as the last digit. It is a calculated value used to verify the integrity of the data.

- ◇ **Disable:** The scanner transmits Interleaved 2 of 5 barcodes as is.
- ◇ **Do Not Transmit Check Digit After Verification:** The scanner checks the integrity of all Interleaved 2 of 5 barcodes to verify that the data complies with the check digit algorithm. Barcodes passing the check will be transmitted except the last digit, whereas those failing it will not be transmitted.
- ◇ **Transmit Check Digit After Verification:** The scanner checks the integrity of all Interleaved 2 of 5 barcodes to verify that the data complies with the check digit algorithm. Barcodes passing the check will be transmitted, whereas those failing it will not be transmitted.

Since Interleaved 2 of 5 must always have an even number of digits, a zero may need to be added as the first digit when the check digit is added. The check digit is automatically generated when making Interleaved 2 of 5 barcodes.



**** 【Disable】**



【Do Not Transmit Check Digit After Verification】



【Transmit Check Digit After Verification】



If the **Do Not Transmit Check Digit After Verification** option is enabled, Interleaved 2 of 5 barcodes with a length that is less than the configured minimum length after having the check digit excluded will not be decoded. (For example, when the **Do Not Transmit Check Digit After Verification** option is enabled and the minimum length is set to 4, Interleaved 2 of 5 barcodes with a total length of 4 characters including the check digit cannot be read.)



**** 【Exit Setup】**



【Enter Setup】

Set Discrete Lengths for Interleaved 2 of 5

The scanner can be configured to only decode Interleaved 2 of 5 barcodes within a specific length range or with a couple of discrete lengths. The length must be an even number not greater than 64 and consist of three digits (a leading zero or zeros may need to be added to meet the length requirement).

The discrete lengths become valid only when the **Enable the Discrete Lengths** option is enabled.



**** 【Disable the Discrete Lengths】**



【Set a Discrete Length】



【Enable the Discrete Lengths】



【Delete a Discrete Length】

E
xample

Set the scanner to decode Interleaved 2 of 5 barcodes containing either 12 or 24 characters:

1. Scan the **Enter Setup** barcode.
2. Scan the **Enable the Discrete Lengths** barcode.
3. Scan the **Set a Discrete Length** barcode.
4. Scan the numeric barcodes —0—1 and —2 (See the **-Digit Barcodes**” section in **Appendix**)
5. Scan the **Save** barcode. (See the **-Save/Cancel Barcodes**” section in **Appendix**)
6. Scan the **Set a Discrete Length** barcode.
7. Scan the numeric barcodes —0—2 and —4
8. Scan the **Save** barcode.
9. Scan the **Exit Setup** barcode.



**** 【Exit Setup】**



【Enter Setup】

Set the scanner to decode Interleaved 2 of 5 barcodes containing between 12 and 24 characters:

1. Scan the **Enter Setup** barcode.
2. Scan the **Enable the Discrete Lengths** barcode.
3. Scan the **Set a Discrete Length** barcode.
4. Scan the numeric barcodes —0—1 and —2
5. Scan the numeric barcodes —0—2 and —4
6. Scan the **Save** barcode.
7. Scan the **Exit Setup** barcode.



****【Exit Setup】**



【Enter Setup】

ITF-14

ITF-14 is a special kind of Interleaved 2 of 5 with a length of 14 characters and the last character as the check character. By default, ITF-14 is disabled.

ITF-14 priority principle: For the Interleaved 2 of 5 barcodes with a length of 14 characters and the last character as the check character, the ITF-14 configurations shall take precedence over the Interleaved 2 of 5 settings.



**** 【Disable ITF-14】**



【Enable ITF-14 But Do Not Transmit Check Digit】



【Enable ITF-14 and Transmit Check Digit】



An example of the ITF-14 priority principle: when ITF-14 is enabled and Interleaved 2 of 5 is disabled, the scanner only decodes Interleaved 2 of 5 barcodes with a length of 14 characters and the last character as the check character.



**** 【Exit Setup】**



【Enter Setup】

ITF-6

ITF-6 is a special kind of Interleaved 2 of 5 with a length of 6 characters and the last character as the check character. By default, ITF-6 is disabled.

ITF-6 priority principle: For the Interleaved 2 of 5 barcodes with a length of 6 characters and the last character as the check character, the ITF-6 configurations shall take precedence over the Interleaved 2 of 5 settings.



**** 【Disable ITF-6】**



【Enable ITF-6 But Do Not Transmit Check Digit】



【Enable ITF-6 and Transmit Check Digit】



An example of the ITF-6 priority principle: when ITF-6 is enabled and Interleaved 2 of 5 is disabled, the scanner only decodes Interleaved 2 of 5 barcodes with a length of 6 characters and the last character as the check character.



**** 【Exit Setup】**



0006010

【Enter Setup】

Matrix 2 of 5

Restore Factory Defaults



0406000

**** 【Restore the Factory Defaults of Matrix 2 of 5】**

Enable/Disable Matrix 2 of 5



0406020

【Enable Matrix 2 of 5】



0406010

**** 【Disable Matrix 2 of 5】**



If the scanner fails to identify Matrix 2 of 5 barcodes, you may first try this solution by scanning the **Enter Setup** barcode and then **Enable Matrix 2 of 5** barcode.



0006000

**** 【Exit Setup】**



【Enter Setup】

Set Length Range for Matrix 2 of 5

The scanner can be configured to only decode Matrix 2 of 5 barcodes with lengths that fall between (inclusive) the minimum and maximum lengths. To accomplish it, you need to set the minimum and maximum lengths.



【Set the Minimum Length (Default: 4)】



【Set the Maximum Length (Default: 80)】



If minimum length is set to be greater than maximum length, the scanner only decodes Matrix 2 of 5 barcodes with either the minimum or maximum length. If minimum length is same as maximum length, only Matrix 2 of 5 barcodes with that length are to be decoded.



Set the scanner to decode Matrix 2 of 5 barcodes containing between 8 and 12 characters:

1. Scan the **Enter Setup** barcode.
2. Scan the **Set the Minimum Length** barcode.
3. Scan the numeric barcode —8 (See the **Digit Barcodes**” section in **Appendix**)
4. Scan the **Save** barcode. (See the **Save/Cancel Barcodes**” section in **Appendix**)
5. Scan the **Set the Maximum Length** barcode.
6. Scan the numeric barcode —1
7. Scan the numeric barcode —2
8. Scan the **Save** barcode.
9. Scan the **Exit Setup** barcode.



** 【Exit Setup】



【Enter Setup】

Check Digit Verification

A check digit is optional for Matrix 2 of 5 and can be added as the last digit. It is a calculated value used to verify the integrity of the data.

- ◇ **Disable:** The scanner transmits Matrix 2 of 5 barcodes as is.
- ◇ **Do Not Transmit Check Digit After Verification:** The scanner checks the integrity of all Matrix 2 of 5 barcodes to verify that the data complies with the check digit algorithm. Barcodes passing the check will be transmitted except the last digit, whereas those failing it will not be transmitted.
- ◇ **Transmit Check Digit After Verification:** The scanner checks the integrity of all Matrix 2 of 5 barcodes to verify that the data complies with the check digit algorithm. Barcodes passing the check will be transmitted, whereas those failing it will not be transmitted.

Since Matrix 2 of 5 must always have an even number of digits, a zero may need to be added as the first digit when the check digit is added. The check digit is automatically generated when making Matrix 2 of 5 barcodes.



**** 【Disable】**



【Do Not Transmit Check Digit After Verification】



【Transmit Check Digit After Verification】



If the **Do Not Transmit Check Digit After Verification** option is enabled, Matrix 2 of 5 barcodes with a length that is less than the configured minimum length after having the check digit excluded will not be decoded. (For example, when the **Do Not Transmit Check Digit After Verification** option is enabled and the minimum length is set to 4, Matrix 2 of 5 barcodes with a total length of 4 characters including the check digit cannot be read.)



**** 【Exit Setup】**



【 Enter Setup 】

Code 39

Restore Factory Defaults



**** 【 Restore the Factory Defaults of Code 39 】**

Enable/Disable Code 39



**** 【 Enable Code 39 】**



【 Disable Code 39 】



If the scanner fails to identify Code 39 barcodes, you may first try this solution by scanning the **Enter Setup** barcode and then **Enable Code 39** barcode.



**** 【 Exit Setup 】**



0006010

【Enter Setup】

Transmit Start/Stop Character

Code 39 uses an asterisk (*) for both the start and the stop characters. You can choose whether or not to transmit the start/stop characters by scanning the appropriate barcode below.



0408090

**** 【Transmit Start/Stop Character】**



0408080

【Do Not Transmit Start/Stop Character】



0006000

**** 【Exit Setup】**



【Enter Setup】

Set Length Range for Code 39

The scanner can be configured to only decode Code 39 barcodes with lengths that fall between (inclusive) the minimum and maximum lengths. To accomplish it, you need to set the minimum and maximum lengths.



【Set the Minimum Length (Default: 4)】



【Set the Maximum Length (Default: 48)】



If minimum length is set to be greater than maximum length, the scanner only decodes Code 39 barcodes with either the minimum or maximum length. If minimum length is same as maximum length, only Code 39 barcodes with that length are to be decoded.



Set the scanner to decode Code 39 barcodes containing between 8 and 12 characters:

1. Scan the **Enter Setup** barcode.
2. Scan the **Set the Minimum Length** barcode.
3. Scan the numeric barcode —8 (See the **-Digit Barcodes**” section in **Appendix**)
4. Scan the **Save** barcode. (See the **-Save/Cancel Barcodes**” section in **Appendix**)
5. Scan the **Set the Maximum Length** barcode.
6. Scan the numeric barcode —1
7. Scan the numeric barcode —2
8. Scan the **Save** barcode.
9. Scan the **Exit Setup** barcode.



** 【Exit Setup】



【Enter Setup】

Check Digit Verification

A check digit is optional for Code 39 and can be added as the last digit. It is a calculated value used to verify the integrity of the data.

- ◇ **Disable:** The scanner transmits Code 39 barcodes as is.
- ◇ **Do Not Transmit Check Digit After Verification:** The scanner checks the integrity of all Code 39 barcodes to verify that the data complies with the check digit algorithm. Barcodes passing the check will be transmitted except the last digit, whereas those failing it will not be transmitted.
- ◇ **Transmit Check Digit After Verification:** The scanner checks the integrity of all Code 39 barcodes to verify that the data complies with the check digit algorithm. Barcodes passing the check will be transmitted, whereas those failing it will not be transmitted.



**** 【Disable】**



【Do Not Transmit Check Digit After Verification】



【Transmit Check Digit After Verification】



If the **Do Not Transmit Check Digit After Verification** option is enabled, Code 39 barcodes with a length that is less than the configured minimum length after having the check digit excluded will not be decoded. (For example, when the **Do Not Transmit Check Digit After Verification** option is enabled and the minimum length is set to 4, Code 39 barcodes with a total length of 4 characters including the check digit cannot be read.)



**** 【Exit Setup】**



【Enter Setup】

Enable/Disable Code 39 Full ASCII

By default, the scanner is only able to read some ASCII characters. You can configure your scanner to identify all ASCII characters by scanning the appropriate barcode below.



**** 【Disable Code 39 Full ASCII】**



【Enable Code 39 Full ASCII】



**** 【Exit Setup】**



0006010

【Enter Setup】

Codabar

Restore Factory Defaults



0409000

**** 【Restore the Factory Defaults of Codabar】**

Enable/Disable Codabar



0409020

**** 【Enable Codabar】**



0409010

【Disable Codabar】



If the scanner fails to identify Codabar barcodes, you may first try this solution by scanning the **Enter Setup** barcode and then **Enable Codabar** barcode.



0006000

**** 【Exit Setup】**



【Enter Setup】

Set Length Range for Codabar

The scanner can be configured to only decode Codabar barcodes with lengths that fall between (inclusive) the minimum and maximum lengths. To accomplish it, you need to set the minimum and maximum lengths.



【Set the Minimum Length (Default: 2)】



【Set the Maximum Length (Default: 60)】



If minimum length is set to be greater than maximum length, the scanner only decodes Codabar barcodes with either the minimum or maximum length. If minimum length is same as maximum length, only Codabar barcodes with that length are to be decoded.



Set the scanner to decode Codabar barcodes containing between 8 and 12 characters:

1. Scan the **Enter Setup** barcode.
2. Scan the **Set the Minimum Length** barcode.
3. Scan the numeric barcode —8 (See the **-Digit Barcodes**” section in **Appendix**)
4. Scan the **Save** barcode. (See the **-Save/Cancel Barcodes**” section in **Appendix**)
5. Scan the **Set the Maximum Length** barcode.
6. Scan the numeric barcode —1
7. Scan the numeric barcode —2
8. Scan the **Save** barcode.
9. Scan the **Exit Setup** barcode.



** 【Exit Setup】



【Enter Setup】

Check Digit Verification

A check digit is optional for Codabar and can be added as the last digit. It is a calculated value used to verify the integrity of the data.

- ◇ **Disable:** The scanner transmits Codabar barcodes as is.
- ◇ **Do Not Transmit Check Digit After Verification:** The scanner checks the integrity of all Codabar barcodes to verify that the data complies with the check digit algorithm. Barcodes passing the check will be transmitted except the last digit, whereas those failing it will not be transmitted.
- ◇ **Transmit Check Digit After Verification:** The scanner checks the integrity of all Codabar barcodes to verify that the data complies with the check digit algorithm. Barcodes passing the check will be transmitted, whereas those failing it will not be transmitted.



**** 【Disable】**



【Do Not Transmit Check Digit After Verification】



【Transmit Check Digit After Verification】



If the **Do Not Transmit Check Digit After Verification** option is enabled, Codabar barcodes with a length that is less than the configured minimum length after having the check digit excluded will not be decoded. (For example, when the **Do Not Transmit Check Digit After Verification** option is enabled and the minimum length is set to 4, Codabar barcodes with a total length of 4 characters including the check digit cannot be read.)



**** 【Exit Setup】**



0006010

【Enter Setup】

Start/Stop Character

You can set the start/stop characters and choose whether or not to transmit the start/stop characters by scanning the appropriate barcode below.



0409090

**** 【Transmit Start/Stop Character】**



0409080

【Do Not Transmit Start/Stop Character】



0409100

**** 【ABCD/ABCD as the Start/Stop Character】**



0409120

**** 【Start/Stop Character in Uppercase】**



0409110

【ABCD/TN*E as the Start/Stop Character】



0409130

【Start/Stop Character in Lowercase】



0006000

**** 【Exit Setup】**



0006010

【Enter Setup】

Code 93

Restore Factory Defaults



0410000

**** 【Restore the Factory Defaults of Code 93】**

Enable/Disable Code 93

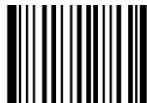

0410010

**** 【Disable Code 93】**



0410020

【Enable Code 93】



If the scanner fails to identify Code 93 barcodes, you may first try this solution by scanning the **Enter Setup** barcode and then **Enable Code 93** barcode.



0006000

**** 【Exit Setup】**



【Enter Setup】

Set Length Range for Code 93

The scanner can be configured to only decode Code 93 barcodes with lengths that fall between (inclusive) the minimum and maximum lengths. To accomplish it, you need to set the minimum and maximum lengths.



【Set the Minimum Length (Default: 1)】



【Set the Maximum Length (Default: 48)】



If minimum length is set to be greater than maximum length, the scanner only decodes Code 93 barcodes with either the minimum or maximum length. If minimum length is same as maximum length, only Code 93 barcodes with that length are to be decoded.



Set the scanner to decode Code 93 barcodes containing between 8 and 12 characters:

1. Scan the **Enter Setup** barcode.
2. Scan the **Set the Minimum Length** barcode.
3. Scan the numeric barcode —8 (See the **-Digit Barcodes**” section in **Appendix**)
4. Scan the **Save** barcode. (See the **-Save/Cancel Barcodes**” section in **Appendix**)
5. Scan the **Set the Maximum Length** barcode.
6. Scan the numeric barcode —1
7. Scan the numeric barcode —2
8. Scan the **Save** barcode.
9. Scan the **Exit Setup** barcode.



** 【Exit Setup】



【Enter Setup】

Check Digit Verification

Check digits are optional for Code 93 and can be added as the last two digits, which are calculated values used to verify the integrity of the data.

- ◇ **Disable:** The scanner transmits Code 93 barcodes as is.
- ◇ **Do Not Transmit Check Digit After Verification:** The scanner checks the integrity of all Code 93 barcodes to verify that the data complies with the check digit algorithm. Barcodes passing the checks will be transmitted except the last two digits, whereas those failing them will not be transmitted.
- ◇ **Transmit Check Digit After Verification:** The scanner checks the integrity of all Code 93 barcodes to verify that the data complies with the check digit algorithm. Barcodes passing the checks will be transmitted, whereas those failing them will not be transmitted.



【Disable】



** **【Do Not Transmit Check Digit After Verification】**



【Transmit Check Digit After Verification】



If the **Do Not Transmit Check Digit After Verification** option is enabled, Code 93 barcodes with a length that is less than the configured minimum length after having the two check digits excluded will not be decoded. (For example, when the **Do Not Transmit Check Digit After Verification** option is enabled and the minimum length is set to 4, Code 93 barcodes with a total length of 4 characters including the two check digits cannot be read.)



** **【Exit Setup】**



【Enter Setup】

UCC/EAN-128

Restore Factory Defaults



**** 【Restore the Factory Defaults of UCC/EAN-128】**

Enable/Disable UCC/EAN-128



**** 【Enable UCC/EAN-128】**



【Disable UCC/EAN-128】



If the scanner fails to identify UCC/EAN-128 barcodes, you may first try this solution by scanning the **Enter Setup** barcode and then **Enable UCC/EAN-128** barcode.



****【Exit Setup】**



0006010

【Enter Setup】

GS1 Databar

Restore Factory Defaults



0413000

**** 【Restore the Factory Defaults of GS1 Databar】**

Enable/Disable GS1 Databar



0413020

**** 【Enable GS1 Databar】**



0413010

【Disable GS1 Databar】



If the scanner fails to identify GS1 Databar barcodes, you may first try this solution by scanning the **Enter Setup** barcode and then **Enable GS1 Databar** barcode.



0006000

**** 【Exit Setup】**



0006010

【Enter Setup】

Transmit Application Identifier “01”



0413060

**** 【Transmit Application Identifier “01”】**



0413050

【Do Not Transmit Application Identifier “01”】



0006000

****【Exit Setup】**



0006010

【Enter Setup】

EAN·UCC Composite

Restore Factory Defaults



0414000

**** 【Restore the Factory Defaults of EAN·UCC Composite】**

Enable/Disable EAN·UCC Composite



0414020

【Enable EAN·UCC Composite】



0414010

**** 【Disable EAN·UCC Composite】**



0414040

【Enable UPC/EAN Composite】



0414030

**** 【Disable UPC/EAN Composite】**



If the scanner fails to identify EAN·UCC Composite barcodes, you may first try this solution by scanning the **Enter Setup** barcode and then **Enable EAN·UCC Composite** barcode.



0006000

**** 【Exit Setup】**



【Enter Setup】

Code 11

Restore Factory Defaults



**** 【Restore the Factory Defaults of Code 11】**

Enable/Disable Code 11



【Enable Code 11】



**** 【Disable Code 11】**



If the scanner fails to identify Code 11 barcodes, you may first try this solution by scanning the **Enter Setup** barcode and then **Enable Code 11** barcode.



****【Exit Setup】**



【Enter Setup】

Set Length Range for Code 11

The scanner can be configured to only decode Code 11 barcodes with lengths that fall between (inclusive) the minimum and maximum lengths. To accomplish it, you need to set the minimum and maximum lengths.



【Set the Minimum Length (Default: 4)】



【Set the Maximum Length (Default: 48)】



If minimum length is set to be greater than maximum length, the scanner only decodes Code 11 barcodes with either the minimum or maximum length. If minimum length is same as maximum length, only Code 11 barcodes with that length are to be decoded.



Set the scanner to decode Code 11 barcodes containing between 8 and 12 characters:

1. Scan the **Enter Setup** barcode.
2. Scan the **Set the Minimum Length** barcode.
3. Scan the numeric barcode —8 (See the **-Digit Barcodes**” section in **Appendix**)
4. Scan the **Save** barcode. (See the **-Save/Cancel Barcodes**” section in **Appendix**)
5. Scan the **Set the Maximum Length** barcode.
6. Scan the numeric barcode —1
7. Scan the numeric barcode —2
8. Scan the **Save** barcode.
9. Scan the **Exit Setup** barcode.



****【Exit Setup】**



0006010
【Enter Setup】

Check Digit Verification

Check digits are optional for Code 11 and can be added as the last one or two digits, which are calculated values used to verify the integrity of the data.

If the **Disable** option is enabled, the scanner transmits Code 11 barcodes as is.



0415050
【Disable】



0415090

【One Check Digit, MOD11 (Len<=10)】
【Two Check Digits, MOD11/MOD11(Len>10)】



0415060

** 【One Check Digit, MOD11】



0415100

【One Check Digit, MOD11 (Len<=10)】
【Two Check Digits, MOD11/MOD9 (Len>10)】



0415070

【Two Check Digits, MOD11/MOD11】



0415110

【Do Not Transmit Check Digit】



0415080

【Two Check Digits, MOD11/MOD9】



0415120

** 【Transmit Check Digit】



0006000
**【Exit Setup】



0006010

【Enter Setup】



If you select a check digit algorithm and the **Do Not Transmit Check Digit** option, Code 11 barcodes with a length that is less than the configured minimum length after having the check digit(s) excluded will not be decoded. (For example, when the **One Check Digit, MOD11** and **Do Not Transmit Check Digit** options are enabled and the minimum length is set to 4, Code 11 barcodes with a total length of 4 characters including the check digit cannot be read.)



0006000

****【Exit Setup】**



【Enter Setup】

ISBN

Restore Factory Defaults



**** 【Restore the Factory Defaults of ISBN】**

Enable/Disable ISBN



【Enable ISBN】



**** 【Disable ISBN】**



If the scanner fails to identify ISBN barcodes, you may first try this solution by scanning the **Enter Setup** barcode and then **Enable ISBN** barcode.



****【Exit Setup】**



0006010

【Enter Setup】

Set ISBN Format



0416030

**** 【ISBN-13】**



0416040

【ISBN-10】



0006000

**** 【Exit Setup】**



【Enter Setup】

Industrial 25

Restore Factory Defaults



**** 【Restore the Factory Defaults of Industrial 25】**

Enable/Disable Industrial 25



【Enable Industrial 25】



**** 【Disable Industrial 25】**



If the scanner fails to identify Industrial 25 barcodes, you may first try this solution by scanning the **Enter Setup** barcode and then **Enable Industrial 25** barcode.



**** 【Exit Setup】**



【Enter Setup】

Set Length Range for Industrial 25

The scanner can be configured to only decode Industrial 25 barcodes with lengths that fall between (inclusive) the minimum and maximum lengths. To accomplish it, you need to set the minimum and maximum lengths.



【Set the Minimum Length (Default: 6)】



【Set the Maximum Length (Default: 48)】



If minimum length is set to be greater than maximum length, the scanner only decodes Industrial 25 barcodes with either the minimum or maximum length. If minimum length is same as maximum length, only Industrial 25 barcodes with that length are to be decoded.



Set the scanner to decode Industrial 25 barcodes containing between 8 and 12 characters:

1. Scan the **Enter Setup** barcode.
2. Scan the **Set the Minimum Length** barcode.
3. Scan the numeric barcode —8 (See the **-Digit Barcodes**” section in **Appendix**)
4. Scan the **Save** barcode. (See the **-Save/Cancel Barcodes**” section in **Appendix**)
5. Scan the **Set the Maximum Length** barcode.
6. Scan the numeric barcode —1
7. Scan the numeric barcode —2
8. Scan the **Save** barcode.
9. Scan the **Exit Setup** barcode.



****【Exit Setup】**



0006010
【Enter Setup】

Check Digit Verification

A check digit is optional for Industrial 25 and can be added as the last digit. It is a calculated value used to verify the integrity of the data.

- ◇ **Disable:** The scanner transmits Industrial 25 barcodes as is.
- ◇ **Do Not Transmit Check Digit After Verification:** The scanner checks the integrity of all Industrial 25 barcodes to verify that the data complies with the check digit algorithm. Barcodes passing the check will be transmitted except the last digit, whereas those failing it will not be transmitted.
- ◇ **Transmit Check Digit After Verification:** The scanner checks the integrity of all Industrial 25 barcodes to verify that the data complies with the check digit algorithm. Barcodes passing the check will be transmitted, whereas those failing it will not be transmitted.



0417050
** 【Disable】



0417060
【Do Not Transmit Check Digit After Verification】



0417070
【Transmit Check Digit After Verification】



If the **Do Not Transmit Check Digit After Verification** option is enabled, Industrial 25 barcodes with a length that is less than the configured minimum length after having the check digit excluded will not be decoded. (For example, when the **Do Not Transmit Check Digit After Verification** option is enabled and the minimum length is set to 4, Industrial 25 barcodes with a total length of 4 characters including the check digit cannot be read.)



0006000
** 【Exit Setup】



0006010

【Enter Setup】

Standard 25

Restore Factory Defaults



0418000

**** 【Restore the Factory Defaults of Standard 25】**

Enable/Disable Standard 25



0418020

【Enable Standard 25】



0418010

**** 【Disable Standard 25】**



If the scanner fails to identify Standard 25 barcodes, you may first try this solution by scanning the **Enter Setup** barcode and then **Enable Standard 25** barcode.



0006000

**** 【Exit Setup】**



【Enter Setup】

Set Length Range for Standard 25

The scanner can be configured to only decode Standard 25 barcodes with lengths that fall between (inclusive) the minimum and maximum lengths. To accomplish it, you need to set the minimum and maximum lengths.



【Set the Minimum Length (Default: 6)】



【Set the Maximum Length (Default: 48)】



If minimum length is set to be greater than maximum length, the scanner only decodes Standard 25 barcodes with either the minimum or maximum length. If minimum length is same as maximum length, only Standard 25 barcodes with that length are to be decoded.



Set the scanner to decode Standard 25 barcodes containing between 8 and 12 characters:

1. Scan the **Enter Setup** barcode.
2. Scan the **Set the Minimum Length** barcode.
3. Scan the numeric barcode —8 (See the **-Digit Barcodes**” section in **Appendix**)
4. Scan the **Save** barcode. (See the **-Save/Cancel Barcodes**” section in **Appendix**)
5. Scan the **Set the Maximum Length** barcode.
6. Scan the numeric barcode —1
7. Scan the numeric barcode —2
8. Scan the **Save** barcode.
9. Scan the **Exit Setup** barcode.



**【Exit Setup】



【Enter Setup】

Check Digit Verification

A check digit is optional for Standard 25 and can be added as the last digit. It is a calculated value used to verify the integrity of the data.

- ◇ **Disable:** The scanner transmits Standard 25 barcodes as is.
- ◇ **Do Not Transmit Check Digit After Verification:** The scanner checks the integrity of all Standard 25 barcodes to verify that the data complies with the check digit algorithm. Barcodes passing the check will be transmitted except the last digit, whereas those failing it will not be transmitted.
- ◇ **Transmit Check Digit After Verification:** The scanner checks the integrity of all Standard 25 barcodes to verify that the data complies with the check digit algorithm. Barcodes passing the check will be transmitted, whereas those failing it will not be transmitted.



**** 【Disable】**



【Do Not Transmit Check Digit After Verification】



【Transmit Check Digit After Verification】



If the **Do Not Transmit Check Digit After Verification** option is enabled, Standard 25 barcodes with a length that is less than the configured minimum length after having the check digit excluded will not be decoded. (For example, when the **Do Not Transmit Check Digit After Verification** option is enabled and the minimum length is set to 4, Standard 25 barcodes with a total length of 4 characters including the check digit cannot be read.)



**** 【Exit Setup】**



【Enter Setup】

Plessey

Restore Factory Defaults



**** 【Restore the Factory Defaults of Plessey】**

Enable/Disable Plessey



【Enable Plessey】



**** 【Disable Plessey】**



If the scanner fails to identify Plessey barcodes, you may first try this solution by scanning the **Enter Setup** barcode and then **Enable Plessey** barcode.



**** 【Exit Setup】**



【Enter Setup】

Set Length Range for Plessey

The scanner can be configured to only decode Plessey barcodes with lengths that fall between (inclusive) the minimum and maximum lengths. To accomplish it, you need to set the minimum and maximum lengths.



【Set the Minimum Length (Default: 4)】



【Set the Maximum Length (Default: 48)】



If minimum length is set to be greater than maximum length, the scanner only decodes Plessey barcodes with either the minimum or maximum length. If minimum length is same as maximum length, only Plessey barcodes with that length are to be decoded.



Set the scanner to decode Plessey barcodes containing between 8 and 12 characters:

1. Scan the **Enter Setup** barcode.
2. Scan the **Set the Minimum Length** barcode.
3. Scan the numeric barcode —8 (See the **-Digit Barcodes**” section in **Appendix**)
4. Scan the **Save** barcode. (See the **-Save/Cancel Barcodes**” section in **Appendix**)
5. Scan the **Set the Maximum Length** barcode.
6. Scan the numeric barcode —1
7. Scan the numeric barcode —2
8. Scan the **Save** barcode.
9. Scan the **Exit Setup** barcode.



****【Exit Setup】**



【Enter Setup】

Check Digit Verification

Check digits are optional for Plessey and can be added as the last two digits, which are calculated values used to verify the integrity of the data.

- ◇ **Disable:** The scanner transmits Plessey barcodes as is.
- ◇ **Do Not Transmit Check Digit After Verification:** The scanner checks the integrity of all Plessey barcodes to verify that the data complies with the check digit algorithm. Barcodes passing the checks will be transmitted except the last two digits, whereas those failing them will not be transmitted.
- ◇ **Transmit Check Digit After Verification:** The scanner checks the integrity of all Plessey barcodes to verify that the data complies with the check digit algorithm. Barcodes passing the checks will be transmitted, whereas those failing them will not be transmitted.



【Disable】



【Do Not Transmit Check Digit After Verification】



**** 【Transmit Check Digit After Verification】**



If the **Do Not Transmit Check Digit After Verification** option is enabled, Plessey barcodes with a length that is less than the configured minimum length after having the check digits excluded will not be decoded. (For example, when the **Do Not Transmit Check Digit After Verification** option is enabled and the minimum length is set to 4, Plessey barcodes with a total length of 4 characters including the check digits cannot be read.)



**** 【Exit Setup】**



【Enter Setup】

MSI-Plessey

Restore Factory Defaults



**** 【Restore the Factory Defaults of MSI-Plessey】**

Enable/Disable MSI-Plessey



【Enable MSI-Plessey】



**** 【Disable MSI-Plessey】**



If the scanner fails to identify MSI-Plessey barcodes, you may first try this solution by scanning the **Enter Setup** barcode and then **Enable MSI-Plessey** barcode.



**** 【Exit Setup】**



【Enter Setup】

Set Length Range for MSI-Plessey

The scanner can be configured to only decode MSI-Plessey barcodes with lengths that fall between (inclusive) the minimum and maximum lengths. To accomplish it, you need to set the minimum and maximum lengths.



【Set the Minimum Length (Default: 4)】



【Set the Maximum Length (Default: 48)】



If minimum length is set to be greater than maximum length, the scanner only decodes MSI-Plessey barcodes with either the minimum or maximum length. If minimum length is same as maximum length, only MSI-Plessey barcodes with that length are to be decoded.



Set the scanner to decode MSI-Plessey barcodes containing between 8 and 12 characters:

1. Scan the **Enter Setup** barcode.
2. Scan the **Set the Minimum Length** barcode.
3. Scan the numeric barcode —8 (See the **-Digit Barcodes**” section in **Appendix**)
4. Scan the **Save** barcode. (See the **-Save/Cancel Barcodes**” section in **Appendix**)
5. Scan the **Set the Maximum Length** barcode.
6. Scan the numeric barcode —1
7. Scan the numeric barcode —2
8. Scan the **Save** barcode.
9. Scan the **Exit Setup** barcode.



**【Exit Setup】



【Enter Setup】

Check Digit Verification

Check digits are optional for MSI-Plessey and can be added as the last one or two digits, which are calculated values used to verify the integrity of the data.

If the **Disable** option is enabled, the scanner transmits MSI-Plessey barcodes as is.



【Disable】



【Two Check Digits, MOD10/MOD11】



**** 【One Check Digit, MOD10】**



【Do Not Transmit Check Digit】



【Two Check Digits, MOD10/MOD10】



**** 【Transmit Check Digit】**



If you select a check digit algorithm and the **Do Not Transmit Check Digit** option, MSI-Plessey barcodes with a length that is less than the configured minimum length after having the check digit(s) excluded will not be decoded. (For example, when the **One Check Digit, MOD10** and **Do Not Transmit Check Digit** options are enabled and the minimum length is set to 4, MSI-Plessey barcodes with a total length of 4 characters including the check digit cannot be read.)



**** 【Exit Setup】**



【Enter Setup】

ISSN

Restore Factory Defaults



**** 【Restore the Factory Defaults of ISSN】**

Enable/Disable ISSN



【Enable ISSN】



**** 【Disable ISSN】**



If the scanner fails to identify ISSN barcodes, you may first try this solution by scanning the **Enter Setup** barcode and then **Enable ISSN** barcode.



****【Exit Setup】**



0006010

【Enter Setup】

PDF417

Restore Factory Defaults



0501000

**** 【Restore the Factory Defaults of PDF417】**

Enable/Disable PDF417



0501020

**** 【Enable PDF417】**



0501010

【Disable PDF417】



If the scanner fails to identify PDF417 barcodes, you may first try this solution by scanning the **Enter Setup** barcode and then **Enable PDF417** barcode.



0006000

**** 【Exit Setup】**



【Enter Setup】

Set Length Range for PDF417

The scanner can be configured to only decode PDF417 barcodes with lengths that fall between (inclusive) the minimum and maximum lengths. To accomplish it, you need to set the minimum and maximum lengths.



【Set the Minimum Length (Default: 1)】



【Set the Maximum Length (Default: 2710)】



Minimum length is not allowed to be greater than maximum length. If you only want to read PDF417 barcodes with a specific length, set both minimum and maximum lengths to be that desired length.



Set the scanner to decode PDF417 barcodes containing between 8 and 12 bytes:

1. Scan the **Enter Setup** barcode.
2. Scan the **Set the Minimum Length** barcode.
3. Scan the numeric barcode —8 (See the **-Digit Barcodes**” section in **Appendix**)
4. Scan the **Save** barcode. (See the **-Save/Cancel Barcodes**” section in **Appendix**)
5. Scan the **Set the Maximum Length** barcode.
6. Scan the numeric barcode —1
7. Scan the numeric barcode —2
8. Scan the **Save** barcode.
9. Scan the **Exit Setup** barcode.



**【Exit Setup】



【Enter Setup】

PDF417 Twin Code

PDF417 twin code is 2 PDF417 barcodes paralleled vertically or horizontally. Two of them must have the same direction and similar specifications and be placed closely together.

There are 3 options for reading PDF417 twin codes:

- ◇ **Single PDF417 Only:** Read either PDF417 code.
- ◇ **Twin PDF417 Only:** Read both PDF417 codes.
- ◇ **Both Single & Twin:** Read both PDF417 codes. If successful, transmit as twin PDF417 only. Otherwise, try single PDF417 only.



**** 【Single PDF417 Only】**



【Twin PDF417 Only】



【Both Single & Twin】



**** 【Exit Setup】**



【Enter Setup】

PDF417 Inverse

Regular barcode: Dark bars on a bright background.

Inverse barcode: Bright bars on a dark background.



**** 【Decode Regular PDF417 Barcodes Only】**



【Decode Inverse PDF417 Barcodes Only】



【Decode Both】

Enable/Disable PDF417 ECI Output



【Disable PDF417 ECI Output】



**** 【Enable PDF417 ECI Output】**



****【Exit Setup】**



0006010

【Enter Setup】

QR Code

Restore Factory Defaults



0502000

**** 【Restore the Factory Defaults of QR Code】**

Enable/Disable QR Code

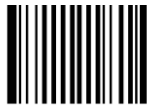

0502020

**** 【Enable QR Code】**

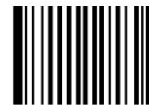

0502010

【Disable QR Code】



If the scanner fails to identify QR Code barcodes, you may first try this solution by scanning the **Enter Setup** barcode and then **Enable QR Code** barcode.



0006000

**** 【Exit Setup】**



【Enter Setup】

Set Length Range for QR Code

The scanner can be configured to only decode QR Code barcodes with lengths that fall between (inclusive) the minimum and maximum lengths. To accomplish it, you need to set the minimum and maximum lengths.



【Set the Minimum Length (Default: 1)】



【Set the Maximum Length (Default: 7089)】



Minimum length is not allowed to be greater than maximum length. If you only want to read QR Code barcodes with a specific length, set both minimum and maximum lengths to be that desired length.

E
xample

Set the scanner to decode QR Code barcodes containing between 8 and 12 bytes:

1. Scan the **Enter Setup** barcode.
2. Scan the **Set the Minimum Length** barcode.
3. Scan the numeric barcode —8 (See the **Digit Barcodes**” section in **Appendix**)
4. Scan the **Save** barcode. (See the **Save/Cancel Barcodes**” section in **Appendix**)
5. Scan the **Set the Maximum Length** barcode.
6. Scan the numeric barcode —1
7. Scan the numeric barcode —2
8. Scan the **Save** barcode.
9. Scan the **Exit Setup** barcode.



**【Exit Setup】



【Enter Setup】

QR Twin Code

QR twin code is 2 QR barcodes paralleled vertically or horizontally. Two of them must have the same direction and similar specifications and be placed closely together.

There are 3 options for reading QR twin codes:

- ◇ **Single QR Only:** Read either QR code.
- ◇ **Twin QR Only:** Read both QR codes. Transmission sequence: left (upper) QR code followed by right (lower) QR code.
- ◇ **Both Single & Twin:** Read both QR codes. If successful, transmit as twin QR only. Otherwise, try single QR only.



**** 【Single QR Only】**



【Both Single & Twin】



【Twin QR Only】

Enable/Disable QR ECI Output



【Disable QR ECI Output】



**** 【Enable QR ECI Output】**



**** 【Exit Setup】**



【Enter Setup】

Aztec

Restore Factory Defaults



**** 【Restore the Factory Defaults of Aztec Code】**

Enable/Disable Aztec Code



【Enable Aztec Code】



**** 【Disable Aztec Code】**



If the scanner fails to identify Aztec barcodes, you may first try this solution by scanning the **Enter Setup** barcode and then **Enable Aztec Code** barcode.



****【Exit Setup】**



【Enter Setup】

Set Length Range for Aztec Code

The scanner can be configured to only decode Aztec barcodes with lengths that fall between (inclusive) the minimum and maximum lengths. To accomplish it, you need to set the minimum and maximum lengths.



【Set the Minimum Length (Default: 1)】



【Set the Maximum Length (Default: 3832)】



Minimum length is not allowed to be greater than maximum length. If you only want to read Aztec barcodes with a specific length, set both minimum and maximum lengths to be that desired length.

E
xample

Set the scanner to decode Aztec barcodes containing between 8 and 12 bytes:

1. Scan the **Enter Setup** barcode.
2. Scan the **Set the Minimum Length** barcode.
3. Scan the numeric barcode —8 (See the **Digit Barcodes**” section in **Appendix**)
4. Scan the **Save** barcode. (See the **Save/Cancel Barcodes**” section in **Appendix**)
5. Scan the **Set the Maximum Length** barcode.
6. Scan the numeric barcode —1
7. Scan the numeric barcode —2
8. Scan the **Save** barcode.
9. Scan the **Exit Setup** barcode.



****【Exit Setup】**



【Enter Setup】

Read Multi-barcodes on an Image

There are three modes:

- ◇ **Mode 1:** Read one barcode only.
- ◇ **Mode 2:** Read fixed number of barcodes only.
- ◇ **Mode 3:** Composite Reading. Read fixed number of barcodes first. If unsuccessful, read one barcode only.



**** 【Mode 1】**



【Mode 2】



【Mode 3】



****【Exit Setup】**



0006010

【Enter Setup】

Set the Number of Barcodes



0503060

** **【1】**



0503064

【5】



0503061

【2】



0503065

【6】



0503062

【3】



0503066

【7】



0503063

【4】



0503067

【8】



0006000

** **【Exit Setup】**



0006010

【Enter Setup】

Enable/Disable Aztec ECI Output



0503101

【Disable Aztec ECI Output】



0503100

****【Enable Aztec ECI Output】**



0006000

****【Exit Setup】**



0006010

【Enter Setup】

Data Matrix

Restore Factory Defaults



0504000

**** 【Restore the Factory Defaults of Data Matrix】**

Enable/Disable Data Matrix



0504020

**** 【Enable Data Matrix】**



0504010

【Disable Data Matrix】



If the scanner fails to identify Data Matrix barcodes, you may first try this solution by scanning the **Enter Setup** barcode and then **Enable Data Matrix** barcode.



0006000

**** 【Exit Setup】**



0006010
【Enter Setup】

Set Length Range for Data Matrix

The scanner can be configured to only decode Data Matrix barcodes with lengths that fall between (inclusive) the minimum and maximum lengths. To accomplish it, you need to set the minimum and maximum lengths.



0504030
【Set the Minimum Length (Default: 1)】



0504040
【Set the Maximum Length (Default: 3116)】



Minimum length is not allowed to be greater than maximum length. If you only want to read Data Matrix barcodes with a specific length, set both minimum and maximum lengths to be that desired length.



Set the scanner to decode Data Matrix barcodes containing between 8 and 12 bytes:

1. Scan the **Enter Setup** barcode.
2. Scan the **Set the Minimum Length** barcode.
3. Scan the numeric barcode —8 (See the **Digit Barcodes**” section in **Appendix**)
4. Scan the **Save** barcode. (See the **Save/Cancel Barcodes**” section in **Appendix**)
5. Scan the **Set the Maximum Length** barcode.
6. Scan the numeric barcode —1
7. Scan the numeric barcode —2
8. Scan the **Save** barcode.
9. Scan the **Exit Setup** barcode.



0006000
**【Exit Setup】



0006010

【Enter Setup】

Data Matrix Twin Code

Data Matrix twin code is 2 Data Matrix barcodes paralleled vertically or horizontally. Two of them must have the same direction and similar specifications and be placed closely together.

There are 3 options for reading Data Matrix twin codes:

- ◇ **Single Data Matrix Only:** Read either Data Matrix code.
- ◇ **Twin Data Matrix Only:** Read both Data Matrix codes. Transmission sequence: left (upper) Data Matrix code followed by right (lower) Data Matrix code.
- ◇ **Both Single & Twin:** Read both Data Matrix codes. If successful, transmit as twin Data Matrix only. Otherwise, try single Data Matrix only.



0504070

**** 【Single Data Matrix Only】**



0504090

【Both Single & Twin】

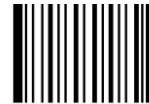

0504080

【Twin Data Matrix Only】



0006000

**** 【Exit Setup】**



0006010
【Enter Setup】

Rectangular Barcode

Data Matrix has two formats:

Square barcodes having the same amount of modules in length and width: 10*10, 12*12.... 144*144.

Rectangular barcodes having different amounts of models in length and width: 6*16, 6*14... 14*22.



0504110
** 【Enable Rectangular Barcode】



0504100
【Disable Rectangular Barcode】

Data Matrix Inverse

Regular barcode: Dark bars on a bright background.

Inverse barcode: Bright bars on a dark background.



0504320
** 【Decode Regular Data Matrix Barcodes Only】



0504321
【Decode Inverse Data Matrix Barcodes Only】



0504322
【Decode Both】



0006000
**【Exit Setup】



0006010

【Enter Setup】

Enable/Disable Data Matrix ECI Output



0504341

【Disable Data Matrix ECI Output】



0504340

**** 【Enable Data Matrix ECI Output】**



0006000

**** 【Exit Setup】**



【Enter Setup】

Maxicode

Restore Factory Defaults



**** 【Restore the Factory Defaults of Maxicode】**

Enable/Disable Maxicode



【Enable Maxicode】



**** 【Disable Maxicode】**



If the scanner fails to identify Maxicode barcodes, you may first try this solution by scanning the **Enter Setup** barcode and then **Enable Maxicode** barcode.



****【Exit Setup】**



【Enter Setup】

Set Length Range for Maxicode

The scanner can be configured to only decode Maxicode barcodes with lengths that fall between (inclusive) the minimum and maximum lengths. To accomplish it, you need to set the minimum and maximum lengths.



【Set the Minimum Length (Default: 1)】



【Set the Maximum Length (Default: 150)】



Minimum length is not allowed to be greater than maximum length. If you only want to read Maxicode barcodes with a specific length, set both minimum and maximum lengths to be that desired length.



Set the scanner to decode Maxicode barcodes containing between 8 and 12 bytes:

1. Scan the **Enter Setup** barcode.
2. Scan the **Set the Minimum Length** barcode.
3. Scan the numeric barcode —8 (See the **Digit Barcodes**” section in **Appendix**)
4. Scan the **Save** barcode. (See the **Save/Cancel Barcodes**” section in **Appendix**)
5. Scan the **Set the Maximum Length** barcode.
6. Scan the numeric barcode —1
7. Scan the numeric barcode —2
8. Scan the **Save** barcode.
9. Scan the **Exit Setup** barcode.



****【Exit Setup】**



【Enter Setup】

Chinese Sensible Code

Restore Factory Defaults



**** 【Restore the Factory Defaults of Chinese Sensible Code】**

Enable/Disable Chinese Sensible Code



【Enable Chinese Sensible Code】



**** 【Disable Chinese Sensible Code】**



If the scanner fails to identify Chinese Sensible Code barcodes, you may first try this solution by scanning the **Enter Setup** barcode and then **Enable Chinese Sensible Code** barcode.



****【Exit Setup】**



【Enter Setup】

Set Length Range for Chinese Sensible Code

The scanner can be configured to only decode Chinese Sensible Code barcodes with lengths that fall between (inclusive) the minimum and maximum lengths. To accomplish it, you need to set the minimum and maximum lengths.



【Set the Minimum Length (Default: 1)】



【Set the Maximum Length (Default: 7827)】



Minimum length is not allowed to be greater than maximum length. If you only want to read Chinese Sensible Code barcodes with a specific length, set both minimum and maximum lengths to be that desired length.



Set the scanner to decode Chinese Sensible Code barcodes containing between 8 and 12 bytes:

1. Scan the **Enter Setup** barcode.
2. Scan the **Set the Minimum Length** barcode.
3. Scan the numeric barcode —8 (See the **-Digit Barcodes**” section in **Appendix**)
4. Scan the **Save** barcode. (See the **-Save/Cancel Barcodes**” section in **Appendix**)
5. Scan the **Set the Maximum Length** barcode.
6. Scan the numeric barcode —1
7. Scan the numeric barcode —2
8. Scan the **Save** barcode.
9. Scan the **Exit Setup** barcode.



****【Exit Setup】**



【Enter Setup】

Chinese Sensible Twin Code

Chinese Sensible twin code is 2 Chinese Sensible barcodes paralleled vertically or horizontally. Two of them must have the same direction and similar specifications and be placed closely together.

There are 3 options for reading Chinese Sensible twin codes:

- ◇ **Single Chinese Sensible Code Only:** Read either Chinese Sensible code.
- ◇ **Twin Chinese Sensible Code Only:** Read both Chinese Sensible codes. Transmission sequence: left (upper) Chinese Sensible code followed by right (lower) Chinese Sensible code.
- ◇ **Both Single & Twin:** Read both Chinese Sensible codes. If successful, transmit as twin Chinese Sensible Code only. Otherwise, try single Chinese Sensible Code only.



**** 【Single Chinese Sensible Code Only】**



【Twin Chinese Sensible Code Only】



【Both Single & Twin】



****【Exit Setup】**



0006010

【Enter Setup】

Chinese Sensible Code Inverse

Regular barcode: Dark bars on a bright background.

Inverse barcode: Bright bars on a dark background.



0508080

**** 【Decode Regular Chinese Sensible Barcodes Only】**



0508081

【Decode Inverse Chinese Sensible Barcodes Only】



0508082

【Decode Both】



0006000

**** 【Exit Setup】**



【Enter Setup】

Chapter 7 Prefix & Suffix

Introduction

A 1D barcode could contain digits, letters, symbols, etc. A 2D barcode could contain more data, such as Chinese characters and other multi-byte characters. However, in real applications, they do not and should not have all information we need, such as barcode type, data acquisition time and delimiter, in order to keep the barcodes short and flexible.

Prefix and suffix are how to fulfill the needs mentioned above. They can be added, removed and modified while the original barcode data remains intact.



Barcode processing procedure:

1. Extract barcode data
2. Append prefix/suffix
3. Pack data
4. Append terminating character and transmit data



**【Exit Setup】



【Enter Setup】

General Settings

Enable/Disable All Prefix/Suffix

Disable All Prefix/Suffix: Transmit barcode data with no prefix/suffix.

Enable All Prefix/Suffix: Allow to append Code ID prefix, AIM ID prefix, custom prefix/suffix and terminating character to the barcode data before the transmission.



**** 【Disable All Prefix/Suffix】**

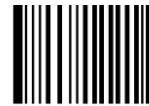

【Enable All Prefix/Suffix】

Prefix Sequences

2 prefix sequence options:



【Code ID + Custom + AIM ID】



【Custom + Code ID + AIM ID】



**** 【Exit Setup】**



【Enter Setup】

Custom Prefix

Enable/Disable Custom Prefix

If custom prefix is enabled, you are allowed to append to the data a user-defined prefix that cannot exceed 10 characters. For example, if the custom prefix is “AB” and the barcode data is “123”, the Host will receive “—AB123”.



** 【Disable Custom Prefix】



【Enable Custom Prefix】

Set Custom Prefix

To set a custom prefix, scan the **Set Custom Prefix** barcode and then the numeric barcodes corresponding to the hexadecimal value of a desired prefix. To save the settings, scan the **Save** barcode.

Note: A custom prefix cannot exceed 10 characters.



【Set Custom Prefix】

E
xample

Set the custom prefix to “CODE” (its hexadecimal value is 0x43/0x4F/0x44/0x45):

1. Scan the **Enter Setup** barcode.
2. Scan the **Set Custom Prefix** barcode.
3. Scan the numeric barcodes “4”, “3”, “4”, “F”, “4”, “4” and “5”. (See the **Digit Barcodes** section in **Appendix**)
4. Scan the **Save** barcode. (See the **Save/Cancel Barcodes** section in **Appendix**)
5. Scan the **Enable Custom Prefix** barcode.
6. Scan the **Exit Setup** barcode.



**【Exit Setup】



【Enter Setup】

AIM ID Prefix

AIM (Automatic Identification Manufacturers) ID defines symbology identifier (For the details, see the “**Appendix 2: AIM ID Table**” section). If AIM ID prefix is enabled, the scanner will add the symbology identifier before the scanned data after decoding.



**** 【Disable AIM ID Prefix】**



【Enable AIM ID Prefix】



AIM ID is not user programmable.

Code ID Prefix

Code ID can also be used to identify barcode type. Unlike AIM ID, Code ID is user programmable. Code ID can only consist of one or two English letters.



**** 【Disable Code ID Prefix】**



【Enable Code ID Prefix】



**** 【Exit Setup】**



【Enter Setup】

Restore All Default Code IDs

For the information of default Code IDs, see the **-Code ID Table**” section in **Appendix**.



【Restore All Default Code IDs】

Modify Code ID

See the examples below to learn how to modify a Code ID and restore the default Code IDs of all symbologies.

E
xample

Modify PDF417 Code ID to be “p” (its hexadecimal value is 0x70):

1. Scan the **Enter Setup** barcode.
2. Scan the **Modify PDF417 Code ID** barcode.
3. Scan the numeric barcodes —7 and —0—. (See the **-Digit Barcodes**” section in **Appendix**)
4. Scan the **Save** barcode. (See the **-Save/Cancel Barcodes**” section in **Appendix**)
5. Scan the **Exit Setup** barcode.

Restore the default Code IDs of all symbologies:

1. Scan the **Enter Setup** barcode.
2. Scan the **Restore All Default Code IDs** barcode.
3. Scan the **Exit Setup** barcode.



**【Exit Setup】



0006010

【Enter Setup】



0005000

【Modify PDF417 Code ID】



0005030

【Modify Data Matrix Code ID】

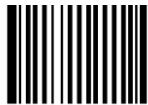

0005010

【Modify QR Code ID】



0005040

【Modify Maxicode Code ID】



0005020

【Modify Aztec Code ID】



0005070

【Modify Chinese Sensible Code ID】



0004040

【Modify EAN-8 Code ID】



0004100

【Modify ITF-6 Code ID】

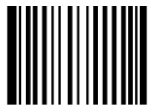

0004050

【Modify EAN-13 Code ID】



0004130

【Modify Code 39 Code ID】



0006000

****【Exit Setup】**



0006010

【Enter Setup】



0004060

【Modify UPC-E Code ID】



0004150

【Modify Codabar Code ID】



0004070

【Modify UPC-A Code ID】



0004170

【Modify Code 93 Code ID】



0004080

【Modify Interleaved 2 of 5 Code ID】



0004020

【Modify Code 128 Code ID】



0004090

【Modify ITF-14 Code ID】



0004240

【Modify ISBN Code ID】



0004030

【Modify UCC/EAN-128 Code ID】



0004250

【Modify Industrial 25 Code ID】



0006000

****【Exit Setup】**



0006010

【Enter Setup】



0004280

【Modify Code 11 Code ID】



0004260

【Modify Standard 25 Code ID】



0004300

【Modify EAN-UCC Composite Code ID】

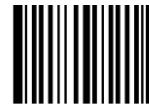

0004270

【Modify Plessey Code ID】



0004310

【Modify GS1 Databar Code ID】



0004290

【Modify MSI-Plessey Code ID】



0004110

【Modify Matrix 2 of 5 Code ID】



0004230

【Modify ISSN Code ID】



0006000

****【Exit Setup】**



【Enter Setup】

Custom Suffix

Enable/Disable Custom Suffix

If custom suffix is enabled, you are allowed to append to the data a user-defined suffix that cannot exceed 10 characters. For example, if the custom suffix is “AB” and the barcode data is “423”, the Host will receive “423AB”.



**** 【Disable Custom Suffix】**



【Enable Custom Suffix】

Set Custom Suffix

To set a custom suffix, scan the **Set Custom Suffix** barcode and then the numeric barcodes corresponding to the hexadecimal value of a desired suffix. To save the settings, scan the **Save** barcode.

Note: A custom suffix cannot exceed 10 characters.



【Set Custom Suffix】

E
sample

Set the custom suffix to “CODE” (its hexadecimal value is 0x43/0x4F/0x44/0x45):

1. Scan the **Enter Setup** barcode.
2. Scan the **Set Custom Suffix** barcode.
3. Scan the numeric barcodes “4”, “3”, “4”, “F”, “4”, “4” and “5”. (See the **Digit Barcodes** section in **Appendix**)
4. Scan the **Save** barcode. (See the **Save/Cancel Barcodes** section in **Appendix**)
5. Scan the **Enable Custom Suffix** barcode.
6. Scan the **Exit Setup** barcode.



****【Exit Setup】**



0006010

【Enter Setup】

Terminating Character Suffix

Enable/Disable Terminating Character Suffix

A terminating character such as carriage return (CR) or carriage return/line feed pair (CRLF) can only be used to mark the end of data, which means nothing can be added after it.

A terminating character suffix cannot be formatted or packed as a custom suffix does.



0309000

**** 【Disable Terminating Character Suffix】**



0309010

【Enable Terminating Character Suffix】



0006000

**** 【Exit Setup】**



0006010
【Enter Setup】

Set Terminating Character Suffix

To set a terminating character suffix, scan the **Set Terminating Character Suffix** barcode and then the numeric barcodes corresponding to the hexadecimal value of a desired terminating character. To save the settings, scan the **Save** barcode.

Note: A terminating character suffix cannot exceed 2 characters.



0310000
【Set Terminating Character Suffix】



0310010
【Terminating Character 0x0D】



0310020
【Terminating Character 0x0D,0x0A】



0006000
**【Exit Setup】



【Enter Setup】

Chapter 8 Data Extraction & Packing

Introduction

In real applications, barcode data could be divided into several sections, each of which delivers different information, such as the manufacturer ID and product ID. If you only want to transmit the product ID and ignore the manufacturer ID, data extraction can fill the bill. Data extraction makes it possible to transmit selected section(s) of raw barcode data.

Regular data transmission: Decode barcode—>Append prefix—>Append Suffix—>Append terminating character suffix—>Transmit data to the Host

Data transmission with extraction: Decode barcode—>Extract data—>Append prefix—>Append suffix—>Append terminating character suffix—>Transmit data to the Host

Data packing puts the desired data into a certain format.

Data transmission with extraction and packing: Decode barcode—>Extract data—>Append prefix—>Append suffix—>Pack data—>Append terminating character suffix—>Transmit data to the Host

Data Extraction

General Rule No.1: It is symbology specific extraction, which means barcodes of the same type can only adopt one extraction option.

General Rule No.2: The scanner allows up to three extraction options to be stored in the non-volatile memory. If more than three options are programmed, only the last three are to be stored. For instance, if an option is programmed for Code 128, Code 39, QR Code and UPC-A respectively, only the options for Code 39, QR Code and UPC-A will be stored.

General Rule No.3: If different options are programmed for a symbology, only the last option will be stored. For instance, Option A has been programmed for Code 128 and later Option B is programmed for the same barcode type, then Option A will be replaced by Option B.

To enable extraction option(s), scan the **Enable Extraction** barcode



** 【Exit Setup】



【Enter Setup】

If you want to remove the extraction option of a barcode type, follow the steps below:

1. Scan the **Enter Setup** barcode.
2. Scan the **Erase the Extraction Option of a Symbology** barcode.
3. Scan the ID number of the barcode type. (e.g. EAN-13, its ID number is 005. For more information, see the **“Symbology ID Number”** section in **Appendix**)
4. Scan the **Save** barcode. (See the **“Save/Cancel Barcodes”** section in **Appendix**)
5. Scan the **Exit Setup** barcode.



**** 【Disable Extraction】**



【Erase the Extraction Option of a Symbology】



【Enable Extraction】



【Erase the Last Extraction Option】



【Program Extraction Option】



【Erase All Extraction Options】



**** 【Exit Setup】**



【Enter Setup】

Program 1D Extraction Option

When programming a 1D extraction option, you need to scan a string of decimal digit barcodes and obey the following rules:

- ◇ The extraction option is usually comprised of one barcode type section (symbology ID number) and one or more data extraction sections.
- ◇ A barcode type section is composed of a 3-digit symbology ID (e.g. **05**, EAN-13) while a data extraction section include 9 decimal digits, with the first 3 digits indicating extraction direction (000: extract from left to right; 001: extract from right to left), the next 3 digits indicating start position and the last 3 digits indicating end position.
- ◇ One extraction option can only apply to one barcode type.



**** 【Exit Setup】**



【Enter Setup】

Example

When scanning an EAN-13 barcode, send the leftmost character through the 3rd and the last 4th character through the rightmost of the data:

1. Scan the **Enter Setup** barcode.
2. Scan the **Enable Extraction** barcode.
3. Scan the **Program Extraction Option** barcode.
4. Scan the numeric barcodes in the following table, the **Save** barcode and the **Exit Setup** barcode.

Digit	005	000	001	003	001	004	001
Meaning	EAN-13 ID	Left to Right	Start with leftmost char	End with 3rd char	Right to Left	Start with last 4th char	End with rightmost char



Barcode Type Section



Data Extraction Section 1



Data Extraction Section 2

Note:

1. Up to 5 data extraction sections are allowed for one 1D extraction option.
2. Neither the start position nor end position can be greater than 127.
3. Data extraction sections can be overlapped. For instance, section 1: 1st character through the 5th (Left to Right); section 2: 2nd character through the 4th (Left to Right).
4. Start position can be greater than end position. In the example above, data extraction section 2 is “01 004 001”, that means the order of extraction is the last 4th, the last 3rd, the last 2nd and the rightmost.
5. To extract only one character, make start position equal to end position.



** 【Exit Setup】



【Enter Setup】

Program 2D Extraction Option

When programming a 2D extraction option, you need to scan a string of decimal digit barcodes and obey the following rules:

- ◇ The extraction option is usually comprised of one barcode type section (symbology ID number) and one or more data extraction sections.
- ◇ A barcode type section is composed of a 3-digit symbology ID (e.g. —~~03~~, QR Code) while a data extraction section include 15 decimal digits, with the first 3 digits indicating extraction direction (000: extract from left to right; 001: extract from right to left), the next 6 digits indicating start position and the last 6 digits indicating end position. The 6 digits are used to represent a 4-digit decimal number: 0, thousands, hundreds, 0, tens, ones (e.g. —~~0~~1013” for 113).
- ◇ One extraction option can only apply to one barcode type.



**** 【Exit Setup】**



【Enter Setup】

Example

When scanning a QR Code barcode, send the leftmost character through the 20th and the 113th character through the 140th of the data:

1. Scan the **Enter Setup** barcode.
2. Scan the **Enable Extraction** barcode.
3. Scan the **Program Extraction Option** barcode.
4. Scan the numeric barcodes in the following table, the **Save** barcode and the **Exit Setup** barcode.

Digit	033	000	000001	000020	000	001013	001040
Meaning	QR Code ID	Left to Right	Start with leftmost char	End with 20th char	Left to Right	Start with 113th char	End with 140th char

Barcode Type Section

Data Extraction Section 1

Data Extraction Section 2

Note:

1. Up to 3 data extraction sections are allowed for one 2D extraction option.
2. Neither the start position nor end position can be greater than 9999.
3. Data extraction sections can be overlapped. For instance, section 1: 1st character through the 50th (Left to Right); section 2: 2nd character through the 40th (Left to Right).
4. Start position can be greater than end position. In the example above, if data extraction section 1 is "0000020 000001", then the order of the extraction will be the 20th, 19th, 18th... and the leftmost.
5. To extract only one character, make start position equal to end position.

Data Packaging

Introduction

Data packing is designed for a specific group of users who want to have the data packed before transmission. Data packing influences data format, so it is advised to disable this feature when it is not required.



**** 【Exit Setup】**



【Enter Setup】



**** 【Disable Data Packing】**

Normal Pack

Normal Pack format: [STX + ATTR + LEN] + [AL_TYPE + DATA] + [LRC]

- ◇ STX: 0x02
- ◇ ATTR: 0x00
- ◇ LEN: Barcode data length is expressed in 2 bytes ranging from 0x0000 (0) to 0xFFFF (65535).
- ◇ AL_TYPE: 0x36
- ◇ DATA: Raw barcode data.
- ◇ LRC: Check digit.

LRC calculation algorithm: computation sequence: $0xFF + \text{LEN} + \text{AL_TYPE} + \text{DATA}$; computation method is XOR, byte by byte.



【Normal Pack】



**** 【Exit Setup】**



【Enter Setup】

Chapter 9 Batch Programming

Introduction

Batch programming enables users to integrate a batch of commands into a single batch barcode .

Listed below are batch programming rules:

1. Command format: Command + --- + Parameter Value.
2. Each command is terminated by semicolon. Note that there is no space between a command and its terminator semicolon.
3. The last command must be the **Save** command (0000160).
4. Use the barcode generator software to generate a 2D batch barcode.

Example: Create a batch barcode for **Illumination Always On** (0200030), **Sense Mode** (0302010), **Decode Session Timeout** (0313000) = 2s, **Disable the Discrete Lengths** for Interleaved 2 of 5 (0405140):

1. Input the commands:
0200030; 0302010;0313000=2000; 0405140;0000160;
2. Generate a batch barcode.

When setting up a scanner with the above configuration, scan the **Enable Batch Barcode** barcode and then the batch barcode generated.



【Enable Batch Barcode】



**【Exit Setup】



【Enter Setup】

Create a Batch Command

A batch command may contain a number of individual commands each of which is terminated by a semicolon. It must be ended with the **Save** command.

Command Structure: Command (+ --- + Parameter Value)

4 command syntaxes are described as below:

1. Syntax 1: Command

This syntax applies to most configuration situations.

Example:

Set the Baud Rate to 38400bps: **0100060**

Enable the Sense Mode: **0302010**

2. Syntax 2: Command + “=” + Decimal Digit(s)

This syntax applies to the options/features programming which requires the entry of parameter value (decimal), such as the Maximum/Minimum Length, Decode Session Timeout, Timeout Between Decodes (Same Barcode) and Sensitivity.

Example:

Set the Decode Session Timeout to 3000ms: **0313000=3000**

Set the Sensitivity to (level) 10: **0312040=10**

3. Syntax 3: Command + “=” + Hexadecimal Digit(s) (e.g., 0x101a, 0x2C03)

This syntax applies to the features/options programming like the Custom Prefix/Suffix, Terminating Character Suffix, Code ID Suffix, Set/Delete the Discrete Length and Program Extraction Option, which requires the entry of parameter value (hexadecimal).

Example:

Decode Interleaved 2 of 5 barcodes containing between 4 and 26 characters: **0405160=0x041a**

Set the Terminating Character Suffix to CR/LF: **0310000=0x0d0a**

4. Syntax 4: Command + “=” + Double Quotation Marks

For situations where the parameter value is visible character in Syntax 3, this syntax is also appropriate.

Example:

Set the Custom Prefix to AUTO-ID: **0300000=“AUTO-ID”**



****【Exit Setup】**



【Enter Setup】

Create a Batch Barcode

Batch barcodes can be produced in the format of PDF417, QR Code or DataMatrix.

Example: Create a batch barcode for **Illumination Always On, Sense Mode, Decode Session Timeout = 2s, Disable the Discrete Lengths** for Interleaved 2 of 5:

1. Input the following commands:

```
0200030;0302010;0313000=2000;0405140;0000160;
```

2. Generate a PDF417 batch barcode.



**【Exit Setup】



【Enter Setup】

Use Batch Barcode

To put a batch barcode into use, scan the following barcodes.



【Enter Setup】



【Enable Batch Barcode】



【Batch Barcode】



【Exit Setup】



****【Exit Setup】**



【Enter Setup】

Chapter 10 Data Formatter

Introduction

You may use the Data Formatter to modify the scanner's output. For example, you can use the Data Formatter to insert characters at certain points in barcode data or to suppress/ replace/ send certain characters in barcode data as it is scanned.

Normally, when you scan a barcode, it gets outputted automatically; however, when you create a format, you must use a `-send` command (see the “**Send Commands**” section in this chapter) within the format programming to output data. The maximum size of formatter command in a data format is 500 characters. By default, the data formatter is disabled. Enable it when required. If you have changed data format settings, and wish to clear all formats and return to the factory defaults, scan the **Default Data Format** code below.



** 【Default Data Format】

Add a Data Format

Data format is used to edit barcode data only. You can program up to four data formats, i.e. Format_0, Format_1, Format_2 and Format_3. When you create a data format, you must specify the application scope of your data format (such as barcode type and data length) and include formatter commands. When scanned data does not match your data format requirements, you will hear the non-match error beep (if the non-match error beep is ON).

There are two methods to program a data format: Programming with barcodes and programming with a batch command.



**【Exit Setup】



【Enter Setup】

Programming with Barcodes

The following explains how to program a data format by scanning the specific barcodes. Scanning any irrelevant barcode or failing to follow the setting procedure will result in programming failure. To find the alphanumeric barcodes needed to create a data format, see **Appendix: Digit Barcodes**.

Step 1: Scan the **Enter Setup** barcode.

Step 2: Scan the **Add Data Format** barcode.



【Add Data Format】

Step 3: Select data format.

Scan a numeric barcode **0** or **1** or **2** or **3** to set this to Format_0 or Format_1 or Format_2 or Format_3.

Step 4: Select formatter command type.

Specify what type of formatter commands will be used. Scan a numeric barcode **-6** to select formatter command type 6. (See the **“Formatter Command Type 6”** section in this chapter for more information)

Step 5: Set interface type

Scan **999** for any interface type.

Step 6: Set Symbology ID Number

Refer to **Appendix: Symbology ID Number** and find the ID number of the symbology to which you want to apply the data format. Scan three numeric barcodes for the symbology ID number. If you wish to create a data format for all symbologies, scan **999**.

Step 7: Set barcode data length

Specify what length of data will be acceptable for this symbology. Scan the four numeric barcodes that represent the data length. 9999 is a universal number, indicating all lengths. For example, 32 characters should be entered as 0032.

Step 8: Enter formatter command

Refer to the **“Formatter Command Type 6”** section in this chapter. Scan the alphanumeric barcodes that represent the command you need to edit data. For example, when a command is F141, you should scan F141. A command can contain up to 500 characters.

Step 9: Scan the **Save** barcode from **Appendix: Save/Cancel Barcodes** to save your data format.



** **【Exit Setup】**



【Enter Setup】

Example: Program format_0 using formatter command type 6, Code 128 containing 10 characters applicable, send all characters followed by -A”.

- | | |
|-----------------------------------------------|-----------------------------------------------|
| 1. Scan the Enter Setup barcode | Enter the Setup mode |
| 2. Scan the Add Data Format barcode | Add a data format |
| 3. Scan the 0 barcode | Select format_0 |
| 4. Scan the 6 barcode | Select formatter command type 6 |
| 5. Scan the 9 barcode three times | All interface types applicable |
| 6. Scan the barcodes 002 | Only Code 128 applicable |
| 7. Scan the barcodes 0010 | Only a length of 10 characters applicable |
| 8. Scan the alphanumeric barcodes F141 | Send all characters followed by -A” (hex: 41) |
| 9. Scan the Save barcode | Save the data format |



**【Exit Setup】



【Enter Setup】

Programming with a Batch Command

A data format can also be created by a batch command sent from the host device.

Syntax: “nls0323000” + “=” + **Double Quotation Mark (")** + **Parameter Value** + **Double Quotation Mark (")** + “;”

Parameter Value consists of the following elements:

Data format: 0~3 (1 character). 0, 1, 2 and 3 represent Format_0, Format_1, Format_2 and Format_3 respectively.

Formatter command type: 6 (1 character).

Interface type: 999 (3 characters).

Symbology ID Number: The ID number of the symbology to which you want to apply the data format (3 characters). 999 indicates all symbologies.

Data length: The length of data that will be acceptable for this symbology (4 characters). 9999 indicates all lengths. For example, 32 characters should be entered as 0032.

Formatter commands: The command string used to edit data (max. 500 characters). For more information, see the “**Formatter Command Type 6**” section.

Note: A batch command used to create a data format must conform to the syntax above. Returned value 0x06 indicates success; returned value 0x15 indicates failure.

To streamline the programming process, you may as well generate a batch barcode by inputting the batch command (e.g. **0323000=“069990020010F141”;**) used to create a data format. See the “**Use Batch Barcode**” section in Chapter 9 to learn how to put a batch barcode into use.

Example: Program format_0 using formatter command type 6, Code 128 containing 10 characters applicable, send all characters followed by -A”.

Batch command: **nls0323000=“069990020010F141”;**



****【Exit Setup】**



【Enter Setup】

Enable Data Format

After enabling the Data Formatter, you may select a data format you want to use by scanning the appropriate barcode below.



****【Format_0】**



【Format_1】



【Format_2】



【Format_3】

Change Data Format for a Single Scan

You can switch between data formats for a single scan. The next barcode is scanned using the data format selected here, then reverts to the format you have selected above. For example, you may have set your scanner to the data format you saved as Format_3. You can switch to Format_1 for a single trigger pull by scanning the **Single Scan – Format_1** barcode below. The next barcode that is scanned uses Format_1, then reverts back to Format_3.

Note: This setting will be lost by removing power from the scanner, or turning off/ rebooting the device.



【Single Scan – Format_0】



【Single Scan – Format_1】



【Single Scan – Format_2】



【Single Scan – Format_3】



****【Exit Setup】**



【Enter Setup】

Enable/Disable Data Formatter

When Data Formatter is disabled, the data format you have enabled becomes invalid.



**** 【Disable Data Formatter】**

You may wish to require the data to conform to a data format you have created. The following settings can be applied to your data format:

Enable Data Formatter, Required, Keep Prefix/Suffix: Scanned data that meets your data format requirements is modified accordingly and gets outputted along with prefixes and suffixes (if prefix and suffix are enabled). Any data that does not match your data format requirements generates an error beep (if Non-Match Error Beep is turned ON) and the data in that barcode is not transmitted.

Enable Data Formatter, Required, Drop Prefix/Suffix: Scanned data that meets your data format requirements is modified accordingly and gets outputted without prefixes and suffixes (even if prefix and suffix are enabled). Any data that does not match your data format requirements generates an error beep (if Non-Match Error Beep is turned ON) and the data in that barcode is not transmitted.

Enable Data Formatter, Not Required, Keep Prefix/Suffix: Scanned data that meets your data format requirements is modified accordingly and gets outputted along with prefixes and suffixes (if prefix and suffix are enabled). Barcode data that does not match your data format requirements is transmitted as read along with prefixes and suffixes (if prefix and suffix are enabled).

Enable Data Formatter, Not Required, Drop Prefix/Suffix: Scanned data that meets your data format requirements is modified accordingly and gets outputted without prefixes and suffixes (even if prefix and suffix are enabled). Barcode data that does not match your data format requirements is transmitted as read along with prefixes and suffixes (if prefix and suffix are enabled).



**** 【Exit Setup】**



【Enter Setup】



【Enable Data Formatter, Required, Keep Prefix/Suffix】



【Enable Data Formatter, Required, Drop Prefix/Suffix】



【Enable Data Formatter, Not Required, Keep Prefix/Suffix】



【Enable Data Formatter, Not Required, Drop Prefix/Suffix】

Non-Match Error Beep

If Non-Match Error Beep is turned ON, the scanner generates an error beep when a barcode is encountered that does not match your required data format.



**** 【Non-Match Error Beep ON】**



【Non-Match Error Beep OFF】



****【Exit Setup】**



【Enter Setup】

Clear Data Format

There are two methods to remove data format from your scanner:

Delete one data format: Scan the **Clear One** barcode, a numeric barcode (0-3) and the **Save** barcode. For example, to delete Format_2, you should scan the **Clear One** barcode, the **2** barcode and the **Save** barcode.

Delete all data formats: Scan the **Clear All** barcode.



【Clear All】



【Clear One】

Query Data Formats

You may scan the following barcode to get the information of data format(s) you have created. For instance, if you have added Format_0 as per the example in the “**Programming with Barcodes**” section in this chapter, then the query result will be **Data Format0:069990020010F141;**.



【Query Data Formats】



****【Exit Setup】**



【Enter Setup】

Formatter Command Type 6

When working with the Data Formatter, a virtual cursor is moved along your input data string. The following commands are used to both move this cursor to different positions, and to select, replace, and insert data into the final output. For the hex value of ASCII characters involved in the commands, refer to **Appendix: ASCII Table**.

Send Commands

F1 Send all characters

Syntax=F1xx (xx: The insert character's hex value)

Include in the output message all of the characters from the input message, starting from current cursor position, followed by an insert character.

F2 Send a number of characters

Syntax=F2nnxx (nn: The numeric value (00-99) for the number of characters; xx: The insert character's hex value)

Include in the output message a number of characters followed by an insert character. Start from the current cursor position and continue for -nn" characters or through the last character in the input message, followed by character -xx".

F2 Example: Send a number of characters



Send the first 10 characters from the barcode above, followed by a carriage return.

Command string: **F2100D**

F2 is the "Send a number of characters" command

10 is the number of characters to send

0D is the hex value for a CR

The data is output as: **1234567890**

<CR>



****【Exit Setup】**



【Enter Setup】

F3 Send all characters up to a particular character

Syntax=F3ssxx (ss: The particular character's hex value; xx: The insert character's hex value)

Include in the output message all characters from the input message, starting with the character at the current cursor position and continuing to, but not including, the particular character -ss," followed by character -xx." The cursor is moved forward to the -ss" character.

F3 Example: Send all characters up to a particular character



Using the barcode above, send all characters up to but not including "D," followed by a carriage return.

Command string: **F3440D**

F3 is the —Send all characters up to a particular character" command

44 is the hex value for a "D"

0D is the hex value for a CR

The data is output as: **1234567890ABC**

<CR>

E9 Send all but the last characters

Syntax=E9nn (nn: The numeric value (00-99) for the number of characters that will not be sent at the end of the message)

Include in the output message all but the last -nn" characters, starting from the current cursor position. The cursor is moved forward to one position past the last input message character included.

F4 Insert a character multiple times

Syntax=F4xxnn (xx: The insert character's hex value; nn: The numeric value (00-99) for the number of times it should be sent)

Send -xx" character -nn" times in the output message, leaving the cursor in the current position.





0006010
【Enter Setup】

E9 and F4 Example: Send all but the last characters, followed by 2 tabs



Send all characters except for the last 8 from the barcode above, followed by 2 tabs.

Command string: **E908F40902**

E9 is the “Send all but the last characters” command

08 is the number of characters at the end to ignore

F4 is the “Insert a character multiple times” command

09 is the hex value for a horizontal tab

02 is the number of times the tab character is sent

The data is output as: **1234567890AB<tab><tab>**

B3 Insert symbology name

Insert the name of the barcode’s symbology in the output message, without moving the cursor.

B4 Insert barcode length

Insert the barcode’s length in the output message, without moving the cursor. The length is expressed as a numeric string and does not include leading zeros.



0006000
**【Exit Setup】



【Enter Setup】

B3 and B4 Example: Insert the symbology name and length



Send the symbology name and length before the barcode data from the barcode above. Break up these insertions with spaces. End with a carriage return.

Command string: **B3F42001B4F42001F10D**

B3 is the "Insert symbology name" command

F4 is the "Insert a character multiple times" command

20 is the hex value for a space

01 is the number of time the space character is sent

B4 is the "Insert barcode length" command

F4 is the "Insert a character multiple times" command

20 is the hex value for a space

01 is the number of time the space character is sent

F1 is the "Send all characters" command

0D is the hex value for a CR

The data is output as: **Code128 20 1234567890ABCDEFGHIJ**

<CR>

Move Commands

F5 Move the cursor forward a number of characters

Syntax=F5nn (nn: The numeric value (00-99) for the number of characters the cursor should be moved ahead)

Move the cursor ahead "n" characters from current cursor position.



****【Exit Setup】**



【Enter Setup】

F5 Example: Move the cursor forward and send the data



Move the cursor forward 3 characters, then send the rest of the barcode data from the barcode above. End with a carriage return.

Command string: **F503F10D**

F5 is the "Move the cursor forward a number of characters" command

03 is the number of characters to move the cursor

F1 is the "Send all characters" command

0D is the hex value for a CR

The data is output as: **4567890ABCDEFGHIJ**

<CR>

F6 Move the cursor backward a number of characters

Syntax=F6nn (nn: The numeric value (00-99) for the number of characters the cursor should be moved back)

Move the cursor back n characters from current cursor position.

F7 Move the cursor to the beginning

Syntax=F7

Move the cursor to the first character in the input message.

EA Move the cursor to the end

Syntax=EA

Move the cursor to the last character in the input message.



**【Exit Setup】



【Enter Setup】

Search Commands

F8 Search forward for a character

Syntax=F8xx (xx: The search character's hex value)

Search the input message forward for \rightarrow x" character from the current cursor position, leaving the cursor pointing to the \rightarrow x" character.

F8 Example: Send barcode data that starts after a particular character



Search for the letter \rightarrow D" in barcodes and send all the data that follows, including the \rightarrow D". Using the barcode above:

Command string: **F844F10D**

F8 is the \rightarrow Search forward for a character" command

44 is the hex value for \rightarrow D"

F1 is the \rightarrow Send all characters" command

0D is the hex value for a CR

The data is output as: **DEFGHIJ**

<CR>

F9 Search backward for a character

Syntax=F9xx (xx: The search character's hex value)

Search the input message backward for \rightarrow x" character from the current cursor position, leaving the cursor pointing to the \rightarrow x" character.



** **【Exit Setup】**



【Enter Setup】

B0 Search forward for a string

Syntax=B0nnnnS (nnnn: The string length (up to 9999); S: The ASCII hex value of each character in the string)

Search forward for -S" string from the current cursor position, leaving cursor pointing to -S" string. For example, B0000454657374 will search forward for the first occurrence of the 4-character string -Test."

B0 Example: Send barcode data that starts after a string of characters



Search for the letters -FGH" in barcodes and send all the data that follows, including -FGH." Using the barcode above:

Command string: **B00003464748F10D**

B0 is the -Search forward for a string" command

0003 is the string length (3 characters)

46 is the hex value for -F"

47 is the hex value for -G"

48 is the hex value for -H"

F1 is the -Send all characters" command

0D is the hex value for a CR

The data is output as: **FGHIJ**

<CR>

B1 Search backward for a string

Syntax=B1nnnnS (nnnn: The string length (up to 9999); S: The ASCII hex value of each character in the string)

Search backward for -S" string from the current cursor position, leaving cursor pointing to -S" string. For example, B1000454657374 will search backward for the first occurrence of the 4-character string -Test."



**【Exit Setup】



【Enter Setup】

E6 Search forward for a non-matching character

Syntax=E6xx (xx: The search character's hex value)

Search the input message forward for the first non-~~xx~~" character from the current cursor position, leaving the cursor pointing to the non-~~xx~~" character.

E6 Example: Remove zeros at the beginning of barcode data



This example shows a barcode that has been zero filled. You may want to ignore the zeros and send all the data that follows. E6 searches forward for the first character that is not zero, then sends all the data after, followed by a carriage return. Using the barcode above:

Command string: **E630F10D**

E6 is the "Search forward for a non-matching character" command

30 is the hex value for 0

F1 is the "Send all characters" command

0D is the hex value for a CR

The data is output as: **37692**

<CR>

E7 Search backward for a non-matching character

Syntax=E7xx (xx: The search character's hex value)

Search the input message backward for the first non-~~xx~~" character from the current cursor position, leaving the cursor pointing to the non-~~xx~~" character.



****【Exit Setup】**



【Enter Setup】

Miscellaneous Commands

FB Suppress characters

Syntax=FBnnxyy..zz (nn: The numeric value (00-15) for the number of suppressed characters; xyy..zz: The hex value of the characters to be suppressed)

Suppress all occurrences of up to 15 different characters, starting at the current cursor position, as the cursor is advanced by other commands.

FB Example: Remove spaces in barcode data



This example shows a barcode that has spaces in the data. You may want to remove the spaces before sending the data. Using the barcode above:

Command string: **FB0120F10D**

FB is the “Suppress characters” command

01 is the number of the characters to be suppressed

20 is the hex value for a space

F1 is the “Send all characters” command

0D is the hex value for a CR

The data is output as: **34567890**

<CR>



**【Exit Setup】



【Enter Setup】

E4 Replace characters

Syntax=E4nnxx₁xx₂yy₁yy₂...zz₁zz₂ (nn: The total count of the number of characters (characters to be replaced plus replacement characters; xx₁: The characters to be replaced, xx₂: The replacement characters, continuing through zz₁ and zz₂)

Replace up to 15 characters in the output message, without moving the cursor.

E4 Example: Replace zeros with CRs in barcode data



If the barcode has characters that the host application does not want included, you can use the E4 command to replace those characters with something else. In this example, you will replace the zeros in the barcode above with carriage returns.

Command string: **E402300DF10D**

E4 is the "Replace characters" command

02 is the total count of characters to be replaced, plus the replacement characters (0 is replaced by CR, so total characters=2)

30 is the hex value for 0

0D is the hex value for a CR (the character that will replace the 0)

F1 is the "Send all characters" command

0D is the hex value for a CR

The data is output as: **1234**

5678

ABC

<CR>



****【Exit Setup】**

Appendix

Digit Barcodes

After scanning numeric barcode(s), you need to scan the **Save** barcode to save the data.

0~9



0000000

【0】



0000010

【1】



0000020

【2】



0000030

【3】



0000040

【4】



0000050

【5】



0000060

【6】



0000070

【7】



0000080

【8】



0000090

【9】

A~F



0000100

【A】



0000110

【B】



0000120

【C】



0000130

【D】



0000140

【E】



0000150

【F】

Save/Cancel Barcodes

After reading numeric barcode(s), you need to scan the **Save** barcode to save the data. If you scan the wrong digit(s), you can either scan the **Cancel** barcode and then start the configuration all over again, or scan the **Delete the Last Digit** barcode and then the correct digit, or scan the **Delete All digits** barcode and then the digits you want.

For instance, after reading the **Maximum Length** barcode and numeric barcodes —4”, —2and —3 you scan:

- ✧ **Delete the Last Digit:** The last digit —3 will be removed.
- ✧ **Delete All Digits:** All digits —23” will be removed.
- ✧ **Cancel:** The maximum length configuration will be canceled. And the scanner still remains ready to read programming barcode.



【 Save 】



【 Cancel 】



【 Delete the Last Digit 】



【 Delete All Digits 】

Factory Defaults Table

Parameter	Factory Default	Remark
Symbologies		
Code 128		
Code 128	Enabled	
Maximum Length	48	
Minimum Length	1	
EAN-8		
EAN-8	Enabled	
Check Digit	Transmit	
2-Digit Add-On Code	Disabled	
5-Digit Add-On Code	Disabled	
Extend to EAN-13	Disabled	
EAN-13		
EAN-13	Enabled	
Check Digit	Transmit	
2-Digit Add-On Code	Disabled	
5-Digit Add-On Code	Disabled	
UPC-E		
UPC-E	Enabled	
Check Digit	Transmit	
2-Digit Add-On Code	Disabled	
5-Digit Add-On Code	Disabled	
Extend to UPC-A	Disabled	
System Character —0	Do not transmit	
UPC-A		
UPC-A	Enabled	

Parameter	Factory Default	Remark
Check Digit	Transmit	
2-Digit Add-On Code	Disabled	
5-Digit Add-On Code	Disabled	
Preamble Character —0	Do not transmit	
Interleaved 2 of 5		
Interleaved 2 of 5	Enabled	
Check Digit Verification	Disabled	
Check Digit	Do not transmit	
Maximum Length	80	
Minimum Length	6	Minimum length supported: 2
Discrete Length	Disabled	
ITF-6		
ITF-6	Disabled	
ITF-14		
ITF-14	Disabled	
Matrix 2 of 5		
Matrix 2 of 5	Disabled	
Check Digit Verification	Disabled	
Check Digit	Do not transmit	
Maximum Length	80	
Minimum Length	4	Minimum length supported: 4
Code 39		
Code 39	Enabled	
Check Digit Verification	Disabled	
Check Digit	Do not transmit	
Start/Stop Character	Transmit	
Code 39 Full ASCII	Disabled	

Parameter	Factory Default	Remark
Maximum Length	48	
Minimum Length	4	Minimum length supported: 1
Codabar		
Codebar	Enabled	
Check Digit Verification	Disabled	
Check Digit	Do not transmit	
Start/Stop Character	ABCD/ABCD format Uppercase Transmit	
Maximum Length	60	
Minimum Length	2	
Code 93		
Code 93	Disabled	
Check Digit Verification	Enabled	
Check Digit	Do not transmit	
Maximum Length	48	
Minimum Length	1	Minimum length supported: 1
UCC/EAN-128		
UCC/EAN-128	Enabled	
GS1 Databar		
GS1 Databar	Enabled	
Application Identifier (AI) —0*	Transmit	
EAN•UCC Composite		
EAN•UCC Composite	Disabled	
UPC/EAN Composite	Disabled	
Code 11		
Code 11	Disabled	

Parameter	Factory Default	Remark
Check Digit	Transmit	
Check Digit Verification	1 Check Digit, MOD11	
Maximum Length	48	
Minimum Length	4	Minimum length supported: 4
ISBN		
ISBN	Disabled	
ISBN Format	ISBN-13	
Industrial 25		
Industrial 25	Disabled	
Check Digit Verification	Disabled	
Check Digit	Do not transmit	
Maximum Length	48	
Minimum Length	6	Minimum length supported: 4
Standard 25		
Standard 25	Disabled	
Check Digit Verification	Disabled	
Check Digit	Do not transmit	
Maximum Length	48	
Minimum Length	6	Minimum length supported: 4
Plessey		
Plessey	Disabled	
Check Digit Verification	Enabled	
Check Digit	Transmit	
Maximum Length	48	
Minimum Length	4	Minimum length supported: 4
MSI-Plessey		
MSI-Plessey	Disabled	

Parameter	Factory Default	Remark
Check Digit	Transmit	
Check Digit Verification	1 Check Digit, MOD10	
Maximum Length	48	
Minimum Length	4	Minimum length supported: 4
ISSN		
ISSN	Disabled	
PDF 417		
PDF 417	Enabled	
Read Single PDF417 Only	Enabled	
PDF417 Inverse	Decode regular PDF417 barcodes only	
PDF417 ECI Output	Enabled	
Maximum Length	2710	
Minimum Length	1	
QR Code		
QR Code	Enabled	
Read Single QR Only	Enabled	
QR ECI Output	Enabled	
Maximum Length	7089	
Minimum Length	1	
Aztec		
Aztec	Disabled	
Read Multi-barcodes on an Image	Disabled	
Aztec ECI Output	Enabled	
Maximum Length	3832	
Minimum Length	1	
Data Matrix		
Data Matrix	Enabled	

Parameter	Factory Default	Remark
Read Single Data Matrix Only	Enabled	
Read Rectangular Barcode	Enabled	
Data Matrix Inverse	Decode regular Data Matrix barcodes only	
Data Matrix ECI Output	Enabled	
Maximum Length	3116	
Minimum Length	1	
Maxicode		
Maxicode	Disabled	
Maximum Length	150	
Minimum Length	1	
Chinese Sensible Code		
Chinese Sensible Code	Disabled	
Read Single Chinese Sensible Code Only	Enabled	
Chinese Sensible Code Inverse	Decode regular Chinese Sensible barcodes only	
Maximum Length	7827	
Minimum Length	1	

AIM ID Table

Symbology	AIM ID	Possible AIM ID Modifiers (m)
Code 128	JC0	
UCC/EAN-128	JC1	
EAN-8	JE4	
EAN-13	JE0	
EAN-13 with Add-On	JE3	
UPC-E	JE0	
UPC-E with Add-On	JE3	
UPC-A	JE0	
UPC-A with Add-On	JE3	
Interleaved 2 of 5	JIm	0, 1, 3
ITF-6	JIm	1, 3
ITF-14	JIm	1, 3
Matrix 2 of 5	JX0	
Code 39	JAm	0, 1, 3, 4, 5, 7
Codabar	JFm	0, 2, 4
Code 93	JG0	
Code 11	JHm	0, 1, 3
ISBN	JX0	
Industrial 25	JS0	
Standard 25	JR0	
Plessey	JP0	
MSI-Plessey	JMm	0, 1
GS1 Databar	Je0	
EAN•UCC Composite	Jem	0-3
ISSN	JX0	
PDF417	JLm	0-2
QR Code	JQm	0-6
Aztec	Jzm	0-9, A-C
Data Matrix	Jdm	0-6
Maxicode	JUm	0-3
Chinese Sensible Code	JX0	

Note: —ñ represents the AIM modifier character. Refer to ISO/IEC 15424:2008 Information technology – Automatic identification and data capture techniques – Data Carrier Identifiers (including Symbology Identifiers) for AIM modifier character details.

Code ID Table

Symbology	Code ID
Code 128	j
UCC/EAN-128	j
EAN-8	d
EAN-13	d
UPC-E	c
UPC-A	c
Interleaved 2 of 5	e
ITF-6	e
ITF-14	e
Matrix 2 of 5	v
Code 39	b
Codabar	a
Code 93	i
Code 11	H
GS1 Databar	R
EAN•UCC Composite	y
ISBN	B
Industrial 25	l
Standard 25	f
Plessey	n
MSI-Plessey	m
ISSN	g
PDF417	r
QR Code	s
Aztec	z
Data Matrix	u
Maxicode	x
Chinese Sensible Code	h

Symbology ID Number

Symbology	ID Number
Code 128	002
UCC/EAN128	003
EAN-8	004
EAN-13	005
UPC-E	006
UPC-A	007
Interleaved 2 OF 5	008
ITF-14	009
ITF-6	010
Matrix 2 of 5	011
Code 39	013
Codabar	015
Code 93	017
ISBN	024
Industrial25	025
Standard25	026
Plessey	027
Code11	028
MSI-Plessey	029
EAN•UCC Composite	030
GS1 Databar	031
PDF417	032
QR Code	033
Aztec	034
DataMatrix	035
Maxicode	036
Chinese Sensible Code	039

ASCII Table

Hex	Dec	Char
00	0	NUL (Null char.)
01	1	SOH (Start of Header)
02	2	STX (Start of Text)
03	3	ETX (End of Text)
04	4	EOT (End of Transmission)
05	5	ENQ (Enquiry)
06	6	ACK (Acknowledgment)
07	7	BEL (Bell)
08	8	BS (Backspace)
09	9	HT (Horizontal Tab)
0a	10	LF (Line Feed)
0b	11	VT (Vertical Tab)
0c	12	FF (Form Feed)
0d	13	CR (Carriage Return)
0e	14	SO (Shift Out)
0f	15	SI (Shift In)
10	16	DLE (Data Link Escape)
11	17	DC1 (XON) (Device Control 1)
12	18	DC2 (Device Control 2)
13	19	DC3 (XOFF) (Device Control 3)
14	20	DC4 (Device Control 4)

15	21	NAK	(Negative Acknowledgment)
16	22	SYN	(Synchronous Idle)
17	23	ETB	(End of Trans. Block)
18	24	CAN	(Cancel)
19	25	EM	(End of Medium)
1a	26	SUB	(Substitute)
1b	27	ESC	(Escape)
1c	28	FS	(File Separator)
1d	29	GS	(Group Separator)
1e	30	RS	(Request to Send)
1f	31	US	(Unit Separator)
20	32	SP	(Space)
21	33	!	(Exclamation Mark)
22	34	"	(Double Quote)
23	35	#	(Number Sign)
24	36	\$	(Dollar Sign)
25	37	%	(Percent)
26	38	&	(Ampersand)
27	39	`	(Single Quote)
28	40	((Left / Opening Parenthesis)
29	41)	(Right / Closing Parenthesis)
2a	42	*	(Asterisk)
2b	43	+	(Plus)
2c	44	,	(Comma)

2d	45	-	(Minus / Dash)
2e	46	.	(Dot)
2f	47	/	(Forward Slash)
30	48	0	
31	49	1	
32	50	2	
33	51	3	
34	52	4	
35	53	5	
36	54	6	
37	55	7	
38	56	8	
39	57	9	
3a	58	:	(Colon)
3b	59	;	(Semi-colon)
3c	60	<	(Less Than)
3d	61	=	(Equal Sign)
3e	62	>	(Greater Than)
3f	63	?	(Question Mark)
40	64	@	(AT Symbol)
41	65	A	
42	66	B	
43	67	C	
44	68	D	

45	69	E
46	70	F
47	71	G
48	72	H
49	73	I
4a	74	J
4b	75	K
4c	76	L
4d	77	M
4e	78	N
4f	79	O
50	80	P
51	81	Q
52	82	R
53	83	S
54	84	T
55	85	U
56	86	V
57	87	W
58	88	X
59	89	Y
5a	90	Z
5b	91	[(Left / Opening Bracket)
5c	92	\ (Back Slash)

5d	93] (Right / Closing Bracket)
5e	94	^ (Caret / Circumflex)
5f	95	_ (Underscore)
60	96	' (Grave Accent)
61	97	a
62	98	b
63	99	c
64	100	d
65	101	e
66	102	f
67	103	g
68	104	h
69	105	i
6a	106	j
6b	107	k
6c	108	l
6d	109	m
6e	110	n
6f	111	o
70	112	p
71	113	q
72	114	r
73	115	s
74	116	t

75	117	u
76	118	v
77	119	w
78	120	x
79	121	y
7a	122	z
7b	123	{ (Left/ Opening Brace)
7c	124	(Vertical Bar)
7d	125	} (Right/Closing Brace)
7e	126	~ (Tilde)
7f	127	DEL (Delete)



Newland EMEA

+31 (0) 345 87 00 33
info@newland-id.com

Newland D-A-CH

+49 (0) 6182 82916-16
info@newland-id.de

Newland UK

+44 (0) 1442 212 020
sales@newland-id.co.uk

Newland Nordic

+46 (0) 708 847 767
nordic@newland-id.com

Newland Ibérica

+34 (0) 93 303 74 66
info@newland-id.es

Newland France

+31 (0) 345 87 00 33
france@newland-id.com

Newland Middle East

+31 (0) 345 87 00 33
middleeast@newland-id.com

Newland South Africa

+27 (0) 11 553 8010
info@newland-id.co.za

Newland Italy

+39 (0) 342 056 2227
italy@newland-id.com

Newland Russia

+31 (0) 345 87 00 33
russia@newland-id.com

Newland Turkey & Iran

+90 (0) 544 538 40 49
turkey@newland-id.com
iran@newland-id.com