



User's Manual

Gun Type Wireless 2D Image Handheld Scanner

Revision History

Changes to the original manual are listed below:

Version	Date	Description of Version
1.0	2017/6/21	Initial release
1.1	2017/8/2	New battery information
1.2	2017/8/28	Added Multi mode
1.3	2019/5/9	Added (Optional) to cable clip
1.4	2019/6/6	Added GS Substitution for NMVS Application
1.5	2020/4/20	Renamed "Apple mode" to "Smart Phone mode"
1.6	2020/7/27	MSI identifier code setting updated
1.7	2020/9/9	Power off timeout parameter added

Important Notice

No warranty of any kind is made in regard to this material, including, but not limited to, implied warranties of merchantability or fitness for any particular purpose. We are not liable for any errors contained herein nor for incidental or consequential damages in connection with furnishing, performance or use of this material. We shall be under no liability in respect of any defect arising from fair wear and tear, willful damage, negligence, abnormal working conditions, failure to follow the instructions and warnings, or misuse or alteration or repair of the products without written approval. No part of this document may be reproduced, transmitted, stored in a retrieval system, transcribed, or translated into any human or computer or other language in any form or by any means electronic, mechanical, magnetic, optical, chemical, biological, manual or otherwise, except for brief passages which may be quoted for purposes of scholastic or literary review, without express written consent and authorization. We reserve the right to make changes in product design without reservation and without notification. The material in this guide is for information only and is subject to change without notice. All trademarks mentioned herein, registered or otherwise, are the properties of their various, ill, assorted owners.

General Handling Precautions

- Do not dispose the scanner in fire.
- Do not put the scanner directly in the sun or by any heat source.
- Do not use or store the scanner in a very humid place.
- Do not drop the scanner or allow it to collide violently with other objects.
- Do not take the scanner apart without authorization

Guidance for Printing

This manual is in A5 size. Please double check your printer setting before printing it out. When the barcodes are to be printed out for programming, the use of a high-resolution laser printer is strongly suggested for the best scan result.

Radio Notice

This equipment generates uses and can radiate radio frequency energy. If not installed and used in accordance with the instructions in this manual, it may cause interference to radio communications. The equipment has been tested and found to comply with the limits for a Class A computing device pursuant to EN55032 and 47 CFR, Part 2 and Part 15 of the FCC rules. These specifications are designed to provide reasonable protection against interference when operated in a commercial environment.

Radio and Television Interference

Operation of this equipment in a residential area can cause interference to radio or television reception. This can be determined by turning the equipment off and on. The user is encouraged to try to correct the interference by one or more of the following measures:

- Reorient the receiving antenna.
- Relocate the device with respect to the receiver.
- Move the device away from the receiver.
- Plug the device into a different outlet so that the device and the receiver are on different branch circuits.

If necessary the user may consult the manufacturer, and authorized dealer, or experienced radio/television technician for additional suggestions. The user may find the following booklet prepared by the Federal Communications Commission helpful: "How to Identify and Resolve Radio-TV Interference Problems." This booklet is available from the U.S. Government Printing Office, Washington, DC 20402 U.S.A., Stock No. 004000003454.

For CE-Countries

This scanner is in conformity with CE standards. Please note that an approved, CE-marked power supply unit should be used in order to maintain CE conformance.

Wireless Communication

- Wireless technology operates 100M / 75M with communication cradle. Maximum communication range may vary depending on obstacles (person, metal, wall, etc.) or electromagnetic environment.
- The following conditions may affect the sensitivity of wireless communication.
 - There is an obstacle such as a person, metal, or wall between this unit and wireless device.
 - A device using 2.4 GHz frequency, such as a wireless LAN device, cordless telephone, or microwave oven, is in use near this unit.
- Because wireless devices and wireless LAN (IEEE802.11b/g) use the same frequency, microwave interference may occur and resulting in communication speed deterioration, noise, or invalid connection if this unit is used near a wireless LAN device. In such a case, perform the following.
 - Use this unit at least 10 m (about 30 ft) away from the wireless LAN device.

- If this unit is used within 10 m (about 30 ft) of a wireless LAN device, turn off the wireless LAN device.
 - Install this unit and wireless device as near to each other as possible.
- Microwaves emitting from a wireless device may affect the operation of electronic medical devices. Turn off this unit and other wireless devices in the following locations, as it may cause an accident.
 - Where inflammable gas is present, in a hospital, train, airplane, or a petrol station
 - Near automatic doors or a fire alarm
- This unit supports security capabilities that comply with the wireless standard to provide a secure connection when the wireless technology is used, but security may not be enough depending on the setting. Be careful when communicating using wireless technology.
- We do not take any responsibility for the leakage of information during wireless communication.
- Connection with all wireless devices cannot be guaranteed.
 - A device featuring wireless function is required to conform to the wireless standard specified by wireless SIG, and be authenticated.
 - Even if the connected device conforms to the above mentioned wireless standard, some devices may not be connected or work correctly, depending on the features or specifications of the device.
- Depending on the device to be connected, it may require some time to start communication.

Tips to help improve your wireless network

1. Position the access point (host/cradle) in a relatively empty space at central location.

When possible, place the access point in a central location on the high ground (1m or above). If your access point is against an outside wall, the signal will be weak on the other side of the room.

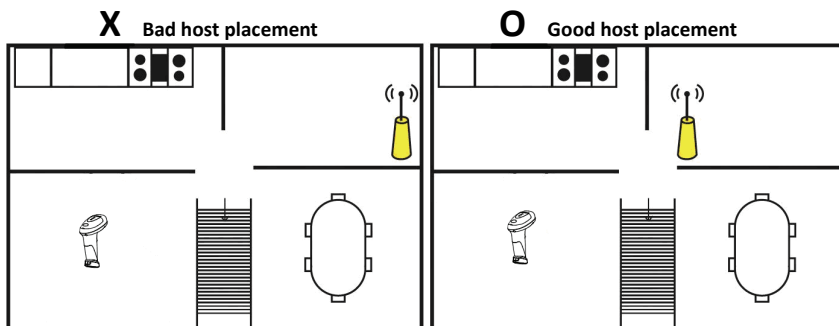

X Bad host placement

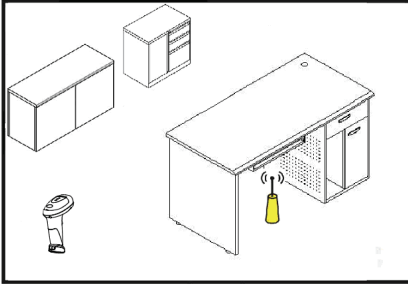

O Good host placement

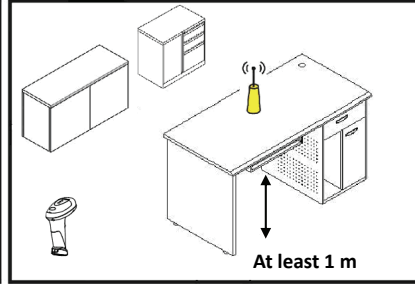

2. Move the access point (host/cradle) off the floor and away from walls and metal objects (such as metal file cabinets). Metal objects, walls, and floors will interfere with your wireless signals. The closer your access point is to these obstructions, the more severe the interference, and the weaker your connection will be.

3. Reduce wireless interference.

The most common wireless technology, 802.11g (wireless-G), operates at a frequency of 2.4 gigahertz (GHz). Many cordless phones, microwave ovens, hospital equipments, refrigerator, LED, and other wireless electronics also use this frequency. If you use these wireless devices in your office, your device might not be able to "hear" the signals over the noise coming from them.

If your network uses wireless-G, you can quiet the noise by avoiding wireless electronics that use the 2.4 GHz frequency. Instead, look for cordless phones and other devices that use the 5.8 GHz or 900 megahertz (MHz) frequencies. Because 802.11n (wireless-N) operates at both 2.4 GHz and the less frequently used 5.0 GHz frequency, you may experience less interference on your network if you use this technology.

Avoid possible wireless interference

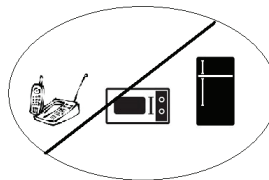

4. Update the firmware or driver of your wireless dongle.

If you are using a wireless dongle or other similar devices to make the connection, getting the latest firmware or driver updates may improve the performance. Visit your manufacturer's website for the updates.

Battery Information

- Use only a ZEBEX approved batteries.
- Using any other type of battery and charging equipment may damage the device and invalidate the warranty.
- Store batteries at half of full charge in a dry, cool place, removed from the equipment to prevent loss of capacity, rusting of metallic parts and electrolyte leakage.
- When batteries are stored over six (6) months, some irreversible deterioration in overall battery quality may occur.
- When storing batteries for over a year, the charge level should be verified at least once every 6 months and charged to half of full charge.

Battery Safety

- The area in which the units are charged should be clear of debris and combustible materials or chemicals. Particular care should be taken where the device is charged in a non-commercial environment.
- Follow battery usage, storage, and charging guidelines found in the user guide.
- Improper battery use may result in a fire, explosion, or other hazard.
- To charge the device battery, the battery and charger temperature must be between 0°C~+45°C
- Do not use incompatible batteries and chargers. Use of an incompatible battery or charger may present a risk of fire, explosion, leakage, or the hazard.
- Do not disassemble or open, crush, bend or deform, puncture, or shred.
- Severe impact from dropping any battery-operated device on a hard surface could cause the battery to overheat.
- Do not short circuit a battery or allow metallic or conductive objects to contact the battery terminals.
- Do not modify or remanufacture, attempt to insert foreign objects into the battery, immerse or expose to water or other liquids, or expose to fire, explosion, or other hazard.
- Do not leave or store the equipment in or near areas that might get very hot, such as in a parked vehicle or near a radiator or other heat source. Do not place battery into a microwave oven or dryer.
- Battery usage by children should be supervised.
- Please follow local regulations to promptly dispose of used re-chargeable batteries.
- Do not dispose of batteries in fire.

- Seek medical advice immediately if a battery has been swallowed. In the event of a battery leak, do not allow the liquid to come in contact with the skin or eyes. If contact has been made, wash the affected area with large amounts of water and seek medical advice.
- Do not short the battery terminals. The battery could overheat.
- Do not attempt to split or peel the outer casing.

Battery Maintenance

These are recommendations to extend the life of the battery pack:

- When charging the battery for the first time, charge for at least 12 hours prior to use.
- Remove the battery if the device is not going to be used for a long time. If the battery is left unused for more than 3 months, you need to charge the battery before use.
- If the battery is not installed, recharge the battery every 6 months to prevent damage to the battery cells.
- The battery capacity is reduced at temperature extremes, high and low.

Table of Contents

Important Notice.....	ii
General Handling Precautions.....	ii
Guidance for Printing.....	ii
For CE-Countries.....	iii
Wireless Communication.....	iii
Battery Information.....	vi
Battery Safety.....	vi
Battery Maintenance.....	vii
Introduction.....	1
Product Overview.....	2
Scanner.....	2
Cradle.....	2
Scanner and Accessories.....	3
Battery Installation.....	4
Installing Cable Clip.....	5
Connecting the Cradle.....	6
Connecting the Cradle.....	7
Charging the Battery.....	8
Power on the Scanner.....	9
How to Scan.....	10
Radio Communication Host Type.....	11
Cradle Host Mode.....	11
SPP Master/SPP Slave Mode.....	11
HID Mode.....	12
Multi Mode.....	12
Paging the Scanner.....	12
Scanner USB online to Host.....	13
USB Online Mode.....	13
Visible Indicators.....	14
Scanner.....	14
Cradle.....	15
Sound Indicators.....	15
ACK/NAK Protocol or Frame Packing.....	16
Pin-out Configuration.....	17
Cable Pin-out.....	18
Programming Guide.....	19
Connecting to a Host.....	24
Cradle Host Mode.....	24
Cradle Host Pairing.....	24
Wireless Mode.....	25

SPP Slave Mode.....	25
SPP Master Mode.....	26
BT HID mode	27
Multi mode.....	27
Smart Phones	28
Multimedia Keyboard.....	29
Setting Pin Code.....	29
Deleting pin code	30
Reset Name	30
Setting Name.....	30
Wireless Discovery	31
Program Settings.....	32
Scan Modes.....	33
USB Online Mode	33
AIM light , illumination Light control.....	34
Radio Communication Settings	34
BT HID mode	34
SPP Master/Slave mode	35
Multi mode.....	36
Functional Settings.....	37
Same Code Delay.....	37
Good Read Beeper Tone Selection	38
Beeper Duration Selection	38
Vibrator Selection	39
Inter Character Delay	39
Inter Message Delay.....	40
Power off Timeout Parameter.....	41
RS-232C Interface Setting.....	42
Parity Bit.....	42
Stop Bit.....	43
Data Bit.....	43
Handshaking Protocol	43
Message Terminator (For Cradle).....	44
Keyboard Wedge Setting (For Cradle).....	45
Message Terminator(For Cradle)	46
Terminator(For Scanner).....	47
Symbology Settings.....	48
CODABAR.....	48
Code39	49
Code 93	51
Code 128	52
Chinese post code(SLZ).....	53

MSI/PLESSY.....	54
CODE 11.....	55
ITF 2 of 5.....	55
Telepen.....	57
Pharmacode.....	57
UPC/EAN/JAN.....	57
Standard 2 of 5.....	63
Industrial 2 of 5.....	64
Matrix 2 of 5.....	65
GS1 Databar.....	66
QR Code.....	68
DataMatrix.....	69
PDF417.....	70
Aztec.....	71
Maxi code.....	71
POST code.....	72
CODABLOC F.....	72
GS Substitution for NMVS Application.....	73
Data Editing.....	73
Full ASCII Data Matrix Table.....	77
Appendix 1: USB Virtual COM Driver Installation.....	89
Appendix 2: Barcode Length Setting.....	90

Introduction

Z-3392BT is the newly designed, rugged, gun-type 2D image readers built for tough environments. The affordable and versatile scanner offers toughness to general applications with great performance. The premier 2D image reader is perfect for retail, warehousing, and asset management. The great value of this scanner makes your buying decision easier than ever.

- Ergonomic, rugged design
- Decode most 1D & 2D barcodes
- Flashing LED indication and programmable beeper
- Affordable high performance

Product Overview

Scanner

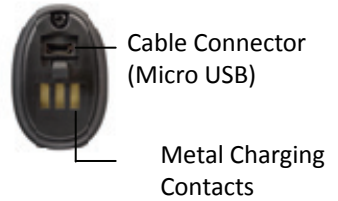

Cradle

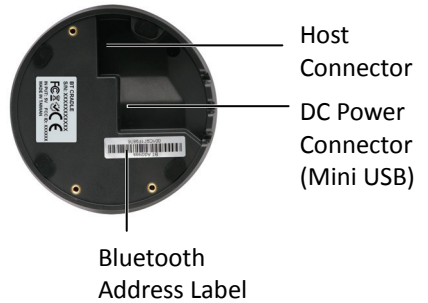

Scanner and Accessories

The scanner package contains:

Wireless scanner with battery /
Scanner cradle (optional)



(with cradle)



(without cradle)

Li-ion battery pack



Communication cable for cradle
(optional)



Mini USB B to USB A cable



5V USB Power adapter



Micro USB B to USB A cable
(optional)



Cable clip (optional)



Battery Installation

Installing Batteries

The rechargeable batteries are packed individually for shipping safety. Please follow the steps below to install the batteries.



Always use the rechargeable batteries provided by the manufacturer to avoid any non-compatible danger or void the warranty.

1. Unscrew the cap from the battery compartment at the bottom of the scanner and insert the battery.



2. Make sure the red tag on the battery is tugged in and not blocking the cable connector and close the cap.



3. Tighten the screw on the cap to secure the battery.

Installing Cable Clip

Optional accessory cable clip is used to hold the micro USB cable in USB Online Mode. With the cable clip, you can easily transform your wireless scanner into a wired one.

Attaching Cable Clip

1. Insert the cable clip to the strap hole as shown.



2. Gently turn the cable clip counter-clockwise and push the cable clip all the way through the strap hole.



3. Attach the bottom part of the cable clip to the scanner handle.



4. Insert the USB cable as illustrated below.

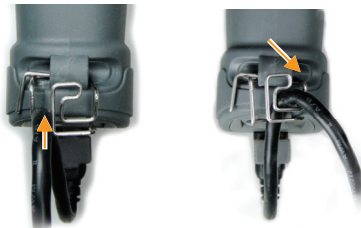

Removing Cable Clip

1. Detach the cable from the clip and detach the bottom part of the cable clip from the scanner handle.



2. Unhook the left part of the cable clip from the strap hole then turn it clockwise. While in turning motion, push the cable clip all the way through.

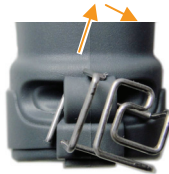

3. Remove the cable clip from the strap hole.

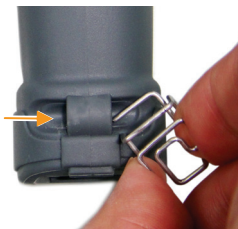

Connecting the Cradle

The cradle host features wireless technology and is designed to support radio communication to the scanner. It can be used for both battery charging and radio communication.

1. Take the desirable interface cable and insert the RJ-45 connector on the bottom of the cradle. You will hear a clear and short “click” sound; then connect the other end to the host.
2. Connect the included USB cable to mini USB port at the bottom of the cradle and connect other end to USB power adaptor.
3. Connect the USB power adaptor into AC outlet. The LED indicator on the cradle should flash blue until it made connection with the scanner.

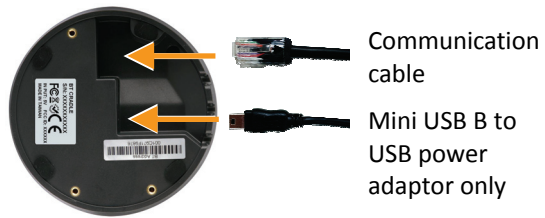

- When using Keyboard wedge and USB interface for cradle communication, it is not necessary to have an external power adapter if host has sufficient power. But these interfaces need external power adapter when charging batteries.
- The mini USB port on the bottom of the cradle should only be connected using the USB power adaptor. Please do not connect the USB cable to a PC host for charging when using the cradle.

Charging the Battery

The scanner offers two different ways to charge the battery: USB Cable or Cradle.

To charge the battery using the cradle:

1. Connect the cradle. Please see [Connecting the Cradle](#) section for more details.
2. Place the scanner on the cradle. You will hear a short beep sound from the scanner indicating scanner is in contact with the cradle.
3. The battery begins charging when the scanner LED indicator starts flashing green. LED turns steady green when charging is complete.



Approx. charging time: 5 hours

To charge the battery using the USB cable:

There are two method to charge scanner via USB cable.

- Host USB Power
 - Power adaptor
1. Connect the micro USB connector directly to the scanner.
 2. Connect the other end of the USB connector to the host to begin charging. You can also connect the USB cable to an outlet using the power adaptor to charge the battery.
 3. The battery begins charging when the scanner LED indicator starts flashing green. LED turns steady green when charging is complete.

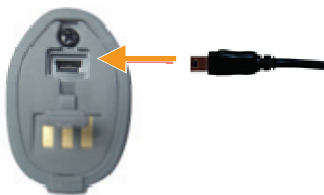

Approx. charging time: 10 hours



- The scanner will power on automatically when charging.
- Batteries shipped may not be full charged and should be fully charged for maximum charge capacity.
- *Recommended* charging environment is temperature in 0°C~35°C (32°F~95°F).

Power on the Scanner

1. Ensure the battery is fully charged. Please refer to the previous section to charge the battery.
2. Press and hold the trigger for 1 second until a long beep sound is heard to turn on the scanner.

How to Scan

There are two ways to scan with this device.

- Handheld scanning
- Presentation scanning

Handheld scanning

1. Power on the scanner.
2. Press the trigger and aim at the barcode as illustrated.
3. When decoding is successful, the scanner beeps and the LED indicates blue.

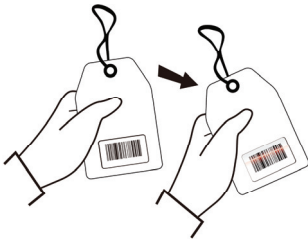

Presentation Scanning

1. Put the scanner into the cradle for presentation scanning.
2. Move the barcode label approach the scanner scanning zone.
3. When decoding is successful, the scanner beeps and the LED indicates blue.

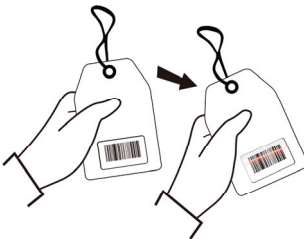

Radio Communication Host Type

This scanner support three radio communication types:

- Cradle Host mode
- SPP master/slave mode
- HID mode

Cradle Host Mode

The scanner communicates with the host through the cradle and the cradle communicates directly to the host via host interface cable connection.

Typically, scanner and cradle in the same delivery box are paired in factory. As soon as both are powered on, they should find and connect to each other immediately.

However, under special circumstance that the scanner and the cradle are not paired with the cradle, please See [Cradle Host Pairing](#) for detail operation information.



SPP Master/SPP Slave Mode

The scanner communicates with the host through wireless connection. Please see for detail operation information.



HID Mode

The scanner communicates with the smart phone through wireless HID connection. Please see for detail operation information



Multi Mode

The scanner communicates with the host through wireless dongle connection. Please see for detail operation information



Paging the Scanner

1. Ensure the cradle is properly connected to the host and LED indicator is showing steady blue.
2. Press the function trigger on the cradle. You should hear the scanner make 3 beep sounds and blue LED flash 3 times if it is in range.

Scanner USB online to Host

The scanner provides other ways for you to connect to the host. When the radio communication is not available, the scanner can be connected to transmit data via USB Online mode. Please see [USB Online Mode](#) for detail operation information.

USB Online Mode

The scanner connects directly to a USB host to recharge and transmit data.



Visible Indicators

Scanner

There are 2 groups of LED indicators on top of the scanner. These indicate the operational status of the scanner.



LED Status		Indication
Group_1	Group_2	
	Blue Flashing	Waiting for radio connection (flash time 0.5s : 0.5s).
	1 Blue fast Flashing	Radio connecting.
	2 Blue Slow Flashing	Device connected (flash time 0.05s : 7s).
	3 1 Blue Flashing	A barcode was decoded successfully (1-2-3)
Green Flashing		Charging mode
Steady Green		Battery fully charged
Red flash once (with 2 beep sound)		low battery warning

Cradle

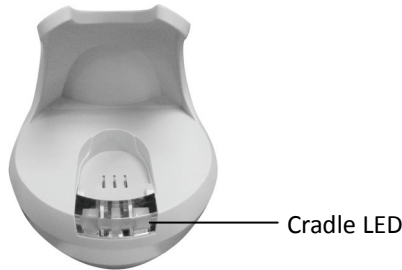

LED Status		Indication
		Red steady and blue continuous flashing
		Steady red and blue
		Red and blue interchange
		Steady blue
		Blue flashing
		Cradle is radio disconnected and power from DC adaptor is lost.
		Cradle is radio connected. But lost DC power from the adaptor.
		USB Interface communication failed.
		Cradle is radio connected.
		Cradle is radio disconnected.

Sound Indicators

When the scanner is in operation, it provides audible feedback. The beeps indicate the status of the scanner.

Beep	Indication
A long beep	Power on scanner.
One beep	A barcode has been successfully decoded and data is either transfer to the host or saved in the memory.
1 high - low - high beeps	Scan cradle pair barcode.
Four short medium beeps	Data communication failed or out of range.
Intermission medium-low beeps	Low battery warning.
1 short medium – low beeps	Scanner is power down.
1 medium – high beeps	Enter programming mode.

ACK/NAK Protocol or Frame Packing

When scanner is in SPP Master/Slave mode, and add in the data protocol or packing could confirm the data reliability. Refer to below for different setting options:

a) No ACK/NAK protocol:

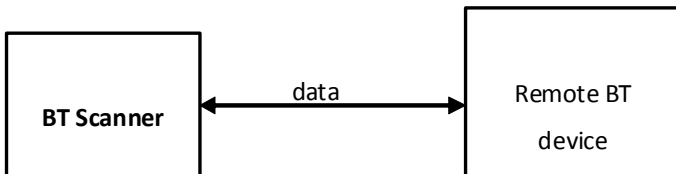

b) ACK/NAK only

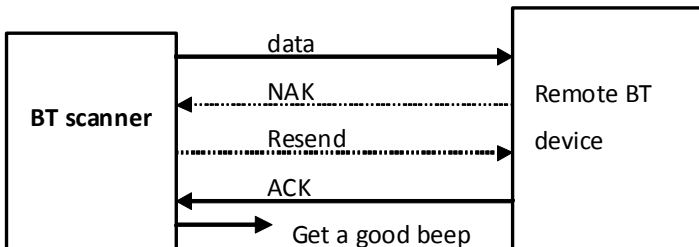

c) Frame packing:

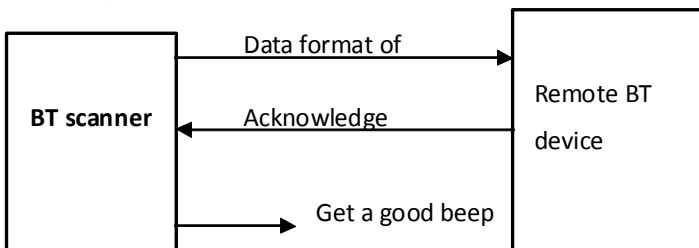

Pin-out Configuration

Scanner Micro USB Pin-Out Configuration	
PIN 1.	+5V
PIN 2.	USB_D-
PIN 3.	USB_D+
PIN 4.	NC
PIN 5.	GND

Cradle Phone Jack Pin-Out Configuration			
RJ 1.	RTS_EIA	RJ 6.	RX_EIA
RJ 2.	KB Data / USB_D+	RJ 7.	KB Clock
RJ 3.	PC Clock / USB_D-	RJ 8.	+5V
RJ 4.	GND	RJ 9.	PC Data
RJ 5.	CTS_EIA	RJ10.	TX_EIA

Cradle Mini USB Pin-Out Configuration	
PIN 1.	DC+5V
PIN 2.	NC
PIN 3.	NC
PIN 4.	NC
PIN 5.	GND

Cable Pin-out

1. Keyboard Wedge Cable (for PS/2)

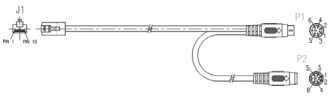
	PIN-OUT CONFIGURATION			
	MINI DIN (M)		MINI DIN(F)	
	DIN	FUNCTION	DIN	FUNCTION
	1.	PC Data	1.	KB Data
	2.	N.C.	2.	N.C.
	3.	GND	3.	GND
	4.	+5V	4.	+5V
5.	PC Clock	5.	KB Clock	
6.	N.C.	6.	N.C.	

2. RS-232 Cable (DTE pin out)

	PIN-OUT CONFIGURATION	
	DB-9 (F)	FUNCTION
	2	TX
	3	RX
	7	CTS
	8	RTS
	5	GND
9	+5V	

3. RS-232 Cable (DCE pin out)

	PIN-OUT CONFIGURATION	
	DB-9 (F)	FUNCTION
	2	RX
	3	TX
	7	CTS
	8	RTS
	5	GND
9	+5V	

4. USB / Virtual COM USB / OPOS USB Interface with Detachable Cable Type A

	USB TYPE A CONNECTOR	FUNCTION
	1.	VCC
	2.	D-
	3.	D+
	4.	VSS

Programming Guide

Program Procedure Using Barcode Manual

1. Power up the scanner.
2. Scan the barcode for the desired feature. Multiple features can be enabled/disabled.
3. For some parameter setting, such as barcode length and identifier code, it is required to scan the Set barcode to save the configuration.

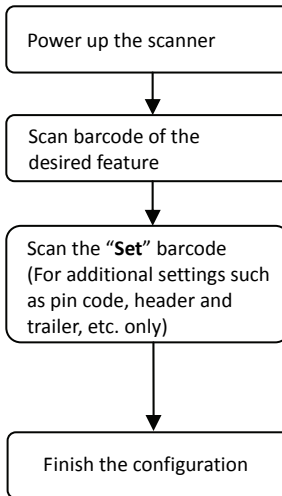

Default Parameters

The factory default setting table gives the default settings of all the programmable parameters. The default settings will be restored whenever the "Reset" programming label is scanned and the scanner is in programming mode. Default values are highlighted in grey background in the settings.

Factory Default Setting

Parameter	Default
Radio communication	
Wireless host	Cradle Host
Pairing mode	Unlocked
Data transmit	Normal
Radio protocol timeout	5 seconds
Power off timeout	20 minutes
Encryption	Enable
Cradle Host	
RS-232 communication	
Baud rate	9600
Parity	none
Data bits	8
Stop bit	1
RTS/CTS	off
Terminator	<CR><LF>
Keyboard Wedge Communication	
Terminator	PC/AT
Keyboard	US keyboard
Terminator	Enter(Alpha numeric)
USB Communication	
Terminator	Enter
Code mode	Scan code
Keyboard	US keyboard
Pair contact on cradle	Enable

Scanner	
Decoder Selection	Default
EAN/UPC	Enable
CODE 39	Enable
Code 32	Disable
CODABAR	Enable
ITF 2 OF 5	Enable
MSI	Disable
Chinese post code	Disable
Code 93	Enable
Code 128	Enable
EAN-128	Disable
Telepen	Disable
Code 11	Disable
Standard 2 of 5	Disable
Industrial 2 of 5	Disable
GS1 DataBar	Disable
Beeper Sound	Default
Frequency	Medium
Duration	Medium
Operating Parameter	Default
Scan mode	Trigger mode
Stand mode	Enable
Header and trailer	None
Inter-message delay	None
Inter-character delay	None
Code Identifiers	Default
Identifier code as ZEBEX standard	Disable
Identifier code as AIM standard	Disable

Code Identifier Settings	ZEBEX	AIM
CODE 39 identifier code setting	M]A0
ITF 2 of 5 identifier code setting	I]I0
CHINESE POST CODE identifier code setting	H]h0
UPC-E identifier code setting	E]E0
UPC-A identifier code setting	A]E0
EAN-13 identifier code setting	F]E0
EAN-8 identifier code setting	FF]E0
CODABAR identifier code setting	N]F0
CODE 128 identifier code setting	K]C0
CODE 93 identifier code setting	L]G0
MSI identifier code setting	P]M0
GS1 Databar identifier code setting	RS]e
GS1 Databar limited identifier code setting	RL]e
GS1 Databar expanded identifier code setting	RX]e
Industrial 2 of 5 Identifier code setting	D]S0
Code 11 Identifier code setting	O]H0
Standard 2 of 5 Identifier code setting	S]R0
Matrix 2of 5 (Japanese) Identifier code setting	G]J0
Telepen identifier code setting	T]T2
PDF417 identifier code setting	p]L0
QR Code identifier code setting	q]Q1
DataMatrix identifier code setting	d]d1
AZTEC identifier code setting	a]z0
Maxi code identifier code setting	m]U0

Default Data Transmit Format

Code	Message format
EAN-13	D1 D2 D3 D4 D5 D6 D7 D8 D9 D10 D11 D12 D13
EAN-8	D1 D2 D3 D4 D5 D6 D7 D8
UPCA	D1 D2 D3 D4 D5 D6 D7 D8 D9 D10 D11 D12
UPCE	D1 D2 D3 D4 D5 D6 D7 D8
CODE128	D1-Dx (default 3~62)
EAN128	C1 D1-Dx (default 3~62)
CODE39	D1-Dx (default 3~62)
CODABAR	D1-Dx (default 6~32)
INTERLEAVED 2/5	D1-Dx (default 14)
CHINESE POST CODE	D1-Dx (default 8~32)
CODE93	D1-Dx (default 4~55)
MSI	D1-Dx (default 6~32)

Connecting to a Host

The scanner provides several data transmit methods to communicate with the host. User may select the method according to their preferences. Read this section to learn the setups for connecting to different hosts.

Cradle Host Mode

The scanner communicates with the host through the cradle. Typically, scanner and cradle in the same delivery box are paired and corresponded to host interface in factory. To check if the scanner is paired to the cradle, check the scanner LED group1 for slow blue flash and check the top cradle LED for steady blue light. If LED group1 of scanner and top LED of cradle are both flashing blue, follow the steps below to radio connect the scanner and cradle.

Cradle Host Pairing

1. See [Connecting the Cradle](#) to connect the cradle and the computer. Please make sure the cradle LED is flashing blue indicating it's not linked to any scanner. If the LED shows steady blue, the cradle is already paired to another scanner so you must unpair the scanner before continuing.
2. Power on the scanner and enable cradle host mode if necessary.



Enable cradle mode

Cradle Host mode enable

3. Use the scanner to scan the pairing barcode at the bottom of the cradle to begin pairing. 3 short beeps will be heard.
4. The LED indicator on the scanner will flash blue rapidly indicating search mode in process. The LED on the cradle becomes steady blue when the pairing is successful.

Wireless Mode

The scanner connects to the host via wireless connection. You may select SPP Master or SPP Slave for PC connection or select HID mode and Smart phone mode for smart phone connection.

SPP Slave Mode

In this mode, the scanner connects to the host /PC via wireless connection and performs like there's a serial connection. In SPP Slave mode, the scanner is discoverable from a remote device and it can request the scanner for connection. There are several ways to connect the wireless scanner to your PC. If you have your own applications please check their User's Manuals for pairing instructions.

To connect a wireless device to Window based system for the first time:

1. Turn on the host computer and activate its wireless connection.
2. Select "Add wireless device". Or open the dialog BT devices and click "Add".
3. Power on the scanner and program it with "SPP Slave mode" label.



Enable wireless SPP Slave mode

Scanner SPP Slave enable

4. On Devices tab, click Add. This will open the Add wireless Device Wizard.
5. Select the "My device is set up and ready to be found" checkbox, and then click Next.
5. The scanner should be on the list of discoverable devices. The default name of the scanner is "Z3392BT". Select "Z3392BT" and click "Next".
6. Select "Let me choose my own passkey" and enter the pin code. The default pin code is "12345678".
7. Click "Next" to connect the scanner to the host. A short beep should be heard upon connection.

SPP Master Mode

In this mode, the scanner connects to the host /PC via wireless connection and performs like there's a serial connection. In master mode, the scanner initiates the connection to the remote device.

1. Power on of the remote device and have its address ready in hand and make it discoverable.
2. Program the scanner with the "SPP Master enable" barcode.



Enable SPP Master mode.

Scanner SPP Master enable

3. Scan "Set wireless address" to set the address.



Set wireless address for SPP Master connection.

Set wireless address
(SPP Master only)

4. Use the ASCII table in Programming Guide to input the 12 digit wireless address. For example: if the address is "011B1345600", scan "0", "0", "1", "1", "B", "1", "3", "4", "5", "6", "0", "0" from ASCII barcode labels, then scan Set barcode to save the configuration.



Set

5. Scan Required Pair with slave (SPP Master) to begin pairing.



Begin pairing with slave device(SPP Master)

Required Pair with slave (SPP Master)

BT HID mode

In BT HID mode, the scanner connects to the host /PC via wireless connection and performs like there's a keyboard connection. The scanner initiates the connection to the remote device.

1. Power on the scanner and program it with "BT HID Mode".



BT HID mode

Enable wireless HID keyboard emulation

2. Enable wireless connection on your host and follow the instructions in your host to set it to discover other wireless devices in its surrounding.
3. The scanner should be on the list of discoverable devices. The default name of the scanner is "Z3392BT". You will be prompt to enter pairing pin code. Select "Z3392BT" and input the pin code that appears on your mobile device to connect scanner to the phone.
4. Scan the Enter barcode to confirm. A short beep should be heard upon connection.

Multi mode

In Multi mode, the scanner connects to the host /PC via dongle wireless connection. The scanner initiates the connection to the remote device.

1. Insert the BT USB dongle in an USB port of the host.
2. Scan barcode below to set 2D BT scanner in Multi Mode.



Multi mode

Enable wireless Multi mode

3. Scan the enclosed **BT address** label to connect the scanner to the host. The LED indicator on the scanner will flash rapidly indicating search mode in process.

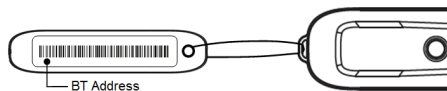

4. The LED on the dongle becomes steady blue when the pairing is successful.
5. To connect other scanners, repeat steps 2 to 4. You may connect up to 7 scanners at the same time.

Note. Scan the barcode below to program the parameter of maximum data size for a single scan.



Maximum data size for a single scan is **256 bytes** /
1 to 7 scanners **(Default)**



Maximum data size for a single scan is **2048 bytes** /
1 to 4 scanners

Smart Phones

For smart phones/tablets with iOS 7 or Android 5.0 and higher:

1. Enable SSP function to connect to the host without a pin code.



Enable Smart Phone
mode

Enable Secure Simple Pairing

2. The scanner should be on the list of discoverable devices. The default name of the scanner is "Z3392BT".
3. Select "Z3392BT" from the list to connect the device.

Multimedia Keyboard

For all other iOS and Android versions (Default Setting):

1. Enable Multimedia keyboard mode to display on-screen keyboard on the mobile device when you press the Function button.



Multimedia Keyboard mode

2. Enable wireless connection on your host and set it to discover other wireless devices in its surrounding.
3. The scanner should be on the list of discoverable devices. The default name of the scanner is "Z3392BT". Select "Z3392BT" from the list.
4. Use the scanner to scan the ASCII table in previous section to input pin code. For example: if the pin code is "0111", scan "0", "1", "1", "1" from ASCII barcode labels, then scan Set barcode to save the configuration.



Set

5. Scan the Enter barcode to confirm.

Setting Pin Code

1. To change the pin code, use the "Set pin code" setting. Default is "12345678".
Set pin code (SPP Master only)



Set pin code

2. Use the ASCII table in Programming Guide to input the new code (must be at least 4 digits and not more than 8 numeric digits) , then scan Set barcode to save the configuration.



Set



Please check the User's Manual from your PC for wireless address and pin code.

Deleting pin code

To delete pin code, use the “Delete pin code setting”.



Delete the stored pin code

Delete pin code

Reset Name

To change the scanner name back to the default name “Z3392BT” use the “Default device name” setting.



Change device name back to default “Z3392BT”

Default device name

Setting Name

1. To change the name displayed when the scanner is discovered, scan the “Friendly device name set” label. Default name is “Z3392BT”.



Change the display name when scanner is discovered

Friendly device name set

2. Use the ASCII table in Programming Guide to input the name (Max.12 digits).
3. Scan “Confirm Setting” to store the new name.



Set

Wireless Discovery

Use the following settings to show or hide the device from wireless discovery.



Discover enable

Make scanner visible to wireless device









Discover disable

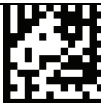

Make scanner invisible to wireless device

Program Settings

Default values are highlighted in grey background.

Barcode Value	Description
	Return scanner to factory defaults
	Return cradle host to factory defaults
	Return to USB default (Communication cradle link required)
	Return to RS232 default (Communication cradle link required)
	Return as USB-virtual COM port default
	Display firmware version
	IBM PC/AT/PS/2 keyboard emulation (Communication cradle link required)







Scan Modes

	<p>Trigger mode The scanner becomes inactive as soon as the data is transmitted. It must be triggered to become active again.</p>
	<p>Auto scan mode The scanner is still active after the data is transmitted but the successive transmission of the same barcode is not allowed when the trigger switch is pressed again.</p>
	<p>Presentation mode Also called auto trigger mode. The scanner is inactive but will automatically detect barcodes presented in the scan zone and become active.</p>





USB Online Mode











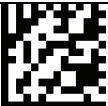

	<p>USB online mode The scanner connects directly to a USB host to recharge and transmit data. You may enable or disable the functions using the following settings.</p>
---	--



AIM light , illumination Light control

		NO_USE_ILLUM
		USE_ILLUM
		NO_USE_AIM
		USE_AIM
		AIM no flash
		AIM flash











Radio Communication Settings





BT HID mode		
		BT HID mode (Combo keyboard)
		For Apple mode (Enter PIN CODE then scan SET)
		Multi Media Keyboard (For Apple Mode)
		Software Keyboard ON/OFF(For Apple Mode)



<i>SPP Master/Slave mode</i>	
	Scanner SPP Master enable SPP Master
	Scanner SPP Slave enable
	Setting wireless address (SPP Master only)
	Set PIN code (SPP Master only)
	Default Device name
	Friendly device name set
	Delete pin code
	Required Pair with slave (SPP Master)
	Discover enable
	Discover disable
	Encryption enable
	Encryption disable



Multi mode		
		Multi mode
		Maximum data size allowed for a single scan is 256 bytes / 1 to 7 scanners
		Maximum data size allowed for a single scan is 2048 bytes /1 to 4 scanners







Functional Settings





Same Code Delay		
		50 msec
		100 msec
		200 msec
		300 msec
		400 msec
		500 msec
		600 msec
		700 msec
		800 msec
		1000 msec
		Infinite









Good Read Beeper Tone Selection	
	Medium beeper tone
	High beeper tone
	Low beeper tone
	Speaker disable







Beeper Duration Selection	
	Long
	Medium
	Short
	Ultra Short
	Ultra Long





<i>Vibrator Selection</i>	
	Vibrator enable
	Vibrator disable





<i>Inter Character Delay</i>	
	0 ms
	2 ms
	5 ms
	10 ms
	20 ms
	50 ms







<i>Inter Message Delay</i>		
		0 ms
		100 ms
		500 ms
		1000 ms





Power off Timeout Parameter	
	Power off timeout=5 min
	Power off timeout=10 min
	Power off timeout=20 min
	Power off timeout=30 min
	Power off timeout=1 hr
	Power Off timeout : 2 hr
	Power Off timeout : 4 hr
	Power Always On
	Power off by scanning this label







RS-232C Interface Setting	
Baud Rate	
	115200
	19200
	9600
	4800
	2400
	1200













Parity Bit	
	Even parity
	Odd parity
	Mark parity
	Space parity
	None parity







Stop Bit		
		1 stop bit
		2 stop bit
Data Bit		
		7 data bit
		8 data bit



Handshaking Protocol		
		None handshaking
		ACK/NAK
		Xon/Xoff
		RTS/CTS
		ACK/NAK response time 300ms
		ACK/NAK response time 2 sec
		ACK/NAK response time 500 ms

	ACK/NAK response time 3 sec
	ACK/NAK response time 1 sec
	ACK/NAK response time 5 sec
	ACK/NAK response time infinity

<i>Message Terminator (For Cradle)</i>	
	RS-232 message terminator—none
	RS-232 message terminator—CR/LF
	RS-232 message terminator—CR
	RS-232 message terminator—LF
	RS-232 message terminator—H tab
	RS-232 message terminator—STX/ETX
	RS-232 message terminator—EOT











Keyboard Wedge Setting (For Cradle)	
	International Keyboard mode (ALT method)
	Keyboard language support---USA
	Keyboard language support---UK send scan code
	Keyboard language support---GERMANY
	Keyboard language support---FRENCH send scan code
	Keyboard language support---SPANISH send scan code
	Keyboard language support---ITALIAN send scan code
	Keyboard language support---Switzerland send scan code
	Keyboard language support---Belgium send scan code
	Keyboard language support---Japanese
	Capital lock on
	Capital lock off





	Function key emulation enable
	Function key emulation disable
	Send number as normal data
	Send number as keypad data
	Alphabet follow as keyboard RS-232 also available
	Alphabet always upper case RS-232 also available
	Alphabet always Lower case RS-232 also available_







Message Terminator(For Cradle)	
	Keyboard terminator---none
	Keyboard terminator---Enter
	Keyboard terminator---H-TAB













<i>Terminator(For Scanner)</i>	
	Message terminator—none
	message terminator—CR/LF
	message terminator—CR
	message terminator—LF
	message terminator—H tab
	message terminator—STX/ETX
	message terminator—EOT
	Alphabet follow as keyboard RS-232 also available
	Alphabet always upper case RS-232 also available
	Alphabet always Lower case RS-232 also available





Symbology Settings

CODABAR	
	Codabar enable
	CODABAR disable
	Codabar data redundant check=off
	Codabar data redundant check=1
	Codabar data redundant check=2
	Codabar data redundant check=3
	Codabar start/stop character transmission-----none
	Codabar start/stop character transmission-----A,B,C,D
	Codabar start/stop character transmission-----DC1~DC4
	Codabar start/stop character transmission-----a/t,b/n,c/*,d/e
	Codabar start/stop character transmission -a,b,c,d









		Codabar maximum length setting
		Codabar minimum length setting
		No check character
		Validate modulo 16, but don't transmit
		Validate modulo 16, but transmit











Code39		
		Code 39 enable
		Code 39 disable
		Code 32 enable
		Code 32 disable
		Code 39 data redundant check=off
		Code 39 data redundant check=1
		Code 39 data redundant check=2









		Code 39 data redundant check=3
		Standard code 39
		FULL ASCII code 39
		Code 39 start/stop character transmission
		Code 39 start/stop character without transmission
		Code 39 check digit calculate and transmit
		Code 39 check digit calculate but without transmit
		No check character
		Code 39 maximum length setting
		Code 39 minimum length setting
		Code39 Data Redundant check = off
		Code39 Data Redundant check = 1











		Code39 Data Redundant check = 2
		Code39 Data Redundant check = 3
		Code 32 (Italian pharmacy)transmit "A" character
		Code 32 (Italian pharmacy)without transmit "A" character







Code 93





		Code 93 enable
		Code 93 disable
		Code 93 data redundant check=off
		Code 93 data redundant check=1
		Code 93 data redundant check=2
		Code 93 data redundant check=3
		Code 93 maximum length setting
		Code 93 minimum length setting











Code 128	
	Code 128 enable
	Code 128 disable
	EAN-128 enable
	EAN-128 disable
	Code 128 data redundant check=off
	Code 128 data redundant check=1
	Code 128 data redundant check=2
	Code 128 data redundant check=3
	Code 128 maximum length setting
	Code 128 minimum length setting



<i>Chinese post code(SLZ)</i>		
		Chinese post code enable
		Chinese post code disable
		Chinese post code data redundant check=off
		Chinese post code data redundant check=1
		Chinese post code data redundant check=2
		Chinese post code data redundant check=3
		Chinese post code check digit calculate and transmit
		Chinese post code check digit calculate but without transmit

<i>MSI/PLESSY</i>	
	MSI enable
	MSI disable
	MSI/PLESSY maximum length setting
	MSI/PLESSY minimum length setting
	MSI/Plessy double check digit calculate but not transmit
	MSI/Plessy double check digit without calculate and transmit
	MSI/Plessy double check digit calculate but only first digit transmit
	MSI/Plessy double check digit calculate and both transmit
	MSI/Plessy single check digit calculate but without transmit
	MSI/Plessy single check digit calculate and transmit







CODE 11		
		CODE 11 enable
		CODE 11 disable
		CODE 11 maximum length setting Default length 6 ~32 character
		CODE 11 minimum length setting
		Disable verification
		Code 11 check digit transmitted
		Code 11 check digit not transmitted













ITF 2 of 5		
		ITF 2 of 5 enable
		ITF 2 of 5 disable
		ITF 25 data redundant check=off
		ITF25 data redundant check=1













		ITF25 data redundant check=2
		ITF 25 data redundant check=3
		ITF 2 of 5 code maximum length setting
		ITF 2 of 5 code minimum length setting
		ITF 2 of 5 no check character
		ITF 2 of 5 check digit calculate and transmit
		ITF 2 of 5 check digit calculate but without transmit
		ITF 2 of 5 one Fixed length setting
		ITF 2 of 5 two Fixed length setting
		ITF 2 of 5 length variable













<i>Telepen</i>	
	Telepen Enable
	Telepen Disable













<i>Pharmacode</i>	
	Pharmacode Enable
	Pharmacode Disable











<i>UPC/EAN/JAN</i>	
	EAN convert to ISSN/ISBN enable
	EAN convert to ISSN/ISBN disable
	UPC/EAN/JAN enable
	UPC/EAN/JAN disable
	EAN-8 OR EAN-13 ENABLE
	UPC-A AND EAN-13 ENABLE







	UPC-A AND UPC-E ENABLE
	UPC-A ENABEL
	UPC-E ENABLE
	EAN-13 ENABLE
	EAN-8 ENABEL
	UPC/EAN ADDon off
	Addon 5 only
	Addon 2 only
	Addon 2 or 5
	Force UPC-E to UPC-A format enable
	Force UPC-E to UPC-A format disable
	Force UPC-A to EAN-13 format enable







		Force UPC-A to EAN-13 format disable
		Transmit UPC-A check digit enable
		Transmit UPC-A check digit disable
		Transmit UPC-E leading character enable
		Transmit UPC-E leading character disable
		Transmit UPC-E check digit enable
		Transmit UPC-E check digit disable
		Transmit EAN-8 check digit enable
		Transmit EAN-8 check digit disable
		Transmit EAN-13 check digit enable
		Transmit EAN-13 check digit disable
		Transmit UPC-A leading character enable









	Transmit UPC-A leading character disable
	Addon format with separator
	Addon format without separator
	EAN/UPC +addon (none mandatory)
	EAN/UPC +addon (mandatory)
	EAN-8 to EAN-13 format enable
	force EAN-8 to EAN-13 format disable
	EAN-13 first "0" can transmitted
	EAN-13 first:"0" can't transmitted
	EAN-13 with first 0 ID code same as "UPC-A"
	EAN-13 with first 0 ID code same as "EAN-13"
	double code disable(9784/192) default













		double code enable(9784/192)
		double code send for other default
		double code not send for other
		EAN/UPC +addon mandatory for 491 Japanese (bookland) Supplement requirement, not sent for other
		EAN/UPC +addon mandatory 491 Japanese (bookland) Supplement requirement, optionally for other
		EAN/UPC +addon mandatory for 978/977 (bookland) Supplement requirement, not sent for other
		EAN/UPC +addon mandatory for 978/977 (bookland) Supplement requirement, optionally for other
		UPC-A data redundant check=off
		UPC-A data redundant check=1
		UPC-A data redundant check=2
		UPC-A data redundant check=3
		UPC-E data redundant check=off







		UPC-E data redundant check=1
		UPC-E data redundant check=2
		UPC-E data redundant check=3
		EAN-13 data redundant check=off
		EAN-13 data redundant check=1
		EAN-13 data redundant check=2
		EAN-13 data redundant check=3
		EAN-8 data redundant check=off
		EAN-8 data redundant check=1
		EAN-8 data redundant check=2
		EAN-8 data redundant check=3











<i>Standard 2 of 5</i>		
		STD 2 of 5 code enable
		STD 2 of 5 code disable
		Standard 2 of 5 check digit calculate and transmit
		Standard 2 of 5 check digit calculate without transmit
		STD 2 of 5 code maximum length setting Default:6~32
		STD 2 of 5 code minimum length setting







<i>Industrial 2 of 5</i>	
	Industrial 2 of 5 Enable
	Industrial 2 of 5 Disable
	Industrial 2 of 5 check digit calculate and transmit
	Industrial 2 of 5 check digit calculate without transmit
	Industrial 2 of 5 code maximum length setting Default:6~32
	Industrial 2 of 5 code minimum length setting









<i>Matrix 2 of 5</i>		
		Matrix 2/5 code enable
		Matrix 2/5 code disable
		Matrix(Japanese) 2/5 code enable
		Matrix(Japanese) 2/5 code disable
		Matrix 2/5 code maximum length setting
		Matrix 2/5 code minimum length setting
		Matrix 2 of 5 check digit calculate and transmit
		Matrix 2 of 5 check digit calculate without transmit







GS1 Databar	
	GS1 Databar enable
	GS1 Databar disable
	GS1 Databar LIMITED enable
	GS1 Databar LIMITED disable
	GS1 Databar EXPANDED enable
	GS1 Databar EXPANDED disable
	GS1 Data Redundant check = off
	GS1 Data Redundant check = 1
	GS1 Data Redundant check = 2
	GS1 Data Redundant check = 3
	GS1 Limited Data Redundant check = off
	GS1 Limited Data Redundant check = 1



	GS1 Limited Data Redundant check = 2
	GS1 Limited Data Redundant check = 3
	GS1 Expanded Data Redundant check = off
	GS1 Expanded Data Redundant check = 1
	GS1 Expanded Data Redundant check = 2
	GS1 Expanded Data Redundant check = 3









<i>QR Code</i>	
	QR Code enable
	QR Code disable
	Micro QR Code enable
	QR Mode1 1 Code enable
	QR Mode1 1 Code disable
	Micro QR Code disable
	QR Code Mirror enable
	QR Code Mirror disable
	QR/MQR polarity setting = Dark on Light
	QR/MQR polarity setting = Light on Dark
	QR/MQR polarity setting = either



<i>DataMatrix</i>		
		DataMatrix enable
		DataMatrix disable
		DataMatrix Mirror enable
		DataMatrix Mirror disable
		DataMatrix polarity setting = Dark on Light
		DataMatrix polarity setting = Light on Dark
		DataMatrix polarity setting = either

PDF417		
		PDF417 enable
		PDF417 disable
		Micro PDF417 enable
		Micro PDF417e disable
		PDF417 Data Redundant check = off
		PDF417 Data Redundant check = 1
		PDF417 Data Redundant check = 2
		PDF417 Data Redundant check = 3

<i>Aztec</i>		
		Aztec enable
		Aztec disable
		Aztec Mirror enable
		Aztec Mirror disable
		Aztec polarity setting = Dark on Light
		Aztec polarity setting = Light on Dark
		Aztec polarity setting = either

<i>Maxi code</i>		
		Maxi code enable
		Maxi code disable



<i>POST code</i>		
		PostNet Enable
		PostNet Disable
		PLANET Enable
		PLANET Disable
		Australia Post Enable
		Australia Post Disable
		Royal Post Enable
		Royal Post Disable

<i>CODABLOC F</i>		
		CODABLOC F Disable
		CODABLOC F CCA Enable
		CODABLOC F CCB Enable







	CODABLOC F CCC Enable
	CODABLOC F ALL Enable













GS Substitution for NMVS Application













This setting enables GS substitution function in barcodes with GS characters.







	NMVS Disable (default) GS Substitution value: CTRL +]
	NMVS Enable GS Substitution value: Alt + 29

Data Editing







	Disable identifier code			
	Enable identifier code table as ZEBEX standard			
	Enable identifier code table as AIM standard. Refer to appendix A.			
	CODE 39 identifier code setting	M]A0	
	ITF 2 of 5 identifier code setting	I]I0	
	CHINESE POST CODE identifier code setting	H]h0	









	UPC-E identifier code setting	E]E0	
	UPC-A identifier code setting	A]E0	
	EAN-13 identifier code setting	F]E0	
	EAN-8 identifier code setting	FF]E0	
	CODABAR identifier code setting	N]F0	
	CODE 128 identifier code setting	K]C0	
	CODE 93 identifier code setting	L]G0	
	MSI identifier code setting	N]M0	
	GS1 Databar identifier code setting	RS]e	
	GS1 Databar limited identifier code setting	RL]e	
	GS1 Databar expanded identifier code setting	RX]e	
	Industrial 2 of 5 Identifier code setting	D]S0	

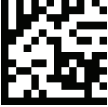









	Code 11 Identifier code setting	O]H0	
	Standard 2 of 5 Identifier code setting	S]R0	
	Matrix 2of 5 (Japanese) Identifier code setting	G]J0	
	Telepen identifier code setting	T]T2	
	PDF417 identifier code setting	p]L0	
	QR Code identifier code setting	q]Q1	
	DataMatrix identifier code setting	d]d1	
	AZTEC identifier code setting	a]z0	
	Maxi code identifier code setting	m]U0	
	Add code length as header enable(all barcode)			
	Add code length as header disable (all barcode)			
	Header (Preamble)			











		Trailer (Post amble)	
		Truncate header character	
		Truncate trailer character	
		Inter message delay 0 ms	
		Inter message delay 100 ms	
		Inter message delay 500 ms	
		Inter message delay 1000 ms	





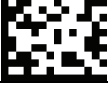



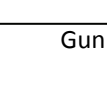

Full ASCII Data Matrix Table

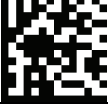









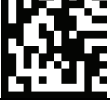

Data Matrix	ASCII	Hexa-code
	Full ASCII ---NUL ~ZBN000000!	00
	Full ASCII ---SOH Function key----“Ins” ~ZBN000100!	01
	Full ASCII ---STX Function key----“Del” ~ZBN000200!	02
	Full ASCII ---ETX Function key---- “Home” ~ZBN000300!	03
	Full ASCII ---EOT Function key---- “End” ~ZB0000400!	04
	Full ASCII ---ENQ Function key----“Up arrow” ~ZBN000500!	05
	Full ASCII ---ACK Function key---- “Down arrow” ~ZBN000600!	06













	Full ASCII ---BEL Function key-----“Left arrow” ~ZBN000700!	07
	Full ASCII ---BS Function key----- “Backspace” ~ZBN000800!	08
	Full ASCII ---HT Function key----- “TAB” ~ZBN000900!	09
	Full ASCII ---LF Function key----- “Enter (alpha numeric” ~ZBN000A00!	0A
	Full ASCII ---VT Function key----- “right arrow” ~ZBN000B00!	0B
	Full ASCII ---FF Function key----- “PgUp” ~ZBN000C00!	0C
	Full ASCII ---CR Function key----- “Enetr(num.)” ~ZBN000D00!	0D
	Full ASCII ---SO Function key----- “PgDn” ~ZBN001E00!	0E
	Full ASCII ---SI Function key----- “Shift” ~ZBN000F00!	0F













	Full ASCII ---DLE Function key---- "5(num)" ~ZB001000!	10	
		Full ASCII ---DC1 Function key----"F1" ~ZBN001100!	11
	Full ASCII ---DC2 Function key----"F2" ~ZBN001200!	12	
		Full ASCII ---DC3 Function key----"F3" ~ZBN001300!	13
	Full ASCII ---DC4 Function key----"F4" ~ZB001400!	14	
		Full ASCII ---NAK Function key----"F5" ~ZBN001500!	15
	Full ASCII ---SYN Function key----"F6" ~ZBN001600!	16	
		Full ASCII ---ETB Function key----"F7" ~ZBN001700!	17
	Full ASCII ---CAN Function key----"F8" ~ZB001800!	18	
		Full ASCII ---EN Function key----"F9" ~ZBN001900!	19
	Full ASCII ---SUB Function key---- "F10" ~ZBN001A00!	1A	











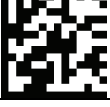

	Full ASCII ---ESC Function key----- “F11” ~ZBN001B00!	1B
	Full ASCII ---FS Function key----- “F12” ~ZBN001C00!	1C
	Full ASCII ---GS Function key----- “ESC” ~ZBN001D00!	1D
	Full ASCII ---RS Function key----- “CTL(L)” ~ZBN001E00!	1E
	Full ASCII ---US Function key----- “ALT(L)” ~ZBN001F00!	1F
	Full ASCII ---SP ~ZBN002000!	20
	Full ASCII ---! ~ZBN002100!	21
	Full ASCII ---“ ~ZBN002200!	22
	Full ASCII ---# ~ZBN002300!	23
	Full ASCII ---\$ ~ZBN002400!	24
	Full ASCII ---% ~ZBN002500!	25











	Full ASCII ---& ~ZBN002600!	26
	Full ASCII ---' ~ZBN002700!	27
	Full ASCII --- (~ZBN002800!	28
	Full ASCII ---) ~ZBN002900!	29
	Full ASCII ---* ~ZBN002A00!	2A
	Full ASCII ---+ ~ZBN002B00!	2B
	Full ASCII ---, ~ZBN002C00!	2C
	Full ASCII ---- ~ZBN002D00!	2D
	Full ASCII ---. ~ZBN002E00!	2E
	Full ASCII ---/ ~ZBN002F00!	2F
	Full ASCII ---0 ~ZBN003000!	30
	Full ASCII ---1 ~ZBN003100!	31

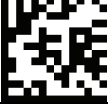

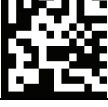









	Full ASCII ---2 ~ZBN003200!	32
	Full ASCII ---3 ~ZBN003300!	33
	Full ASCII ---4 ~ZBN003400!	34
	Full ASCII ---5 ~ZBN003500!	35
	Full ASCII ---6 ~ZBN003600!	36
	Full ASCII ---7 ~ZBN003700!	37
	Full ASCII ---8 ~ZBN003800!	38
	Full ASCII ---9 ~ZBN003900!	39
	Full ASCII ---: ~ZBN003A00!	3A
	Full ASCII ---; ~ZBN003B00!	3B
	Full ASCII ---< ~ZBN003C00!	3C
	Full ASCII ---= ~ZBN003D00!	3D





	Full ASCII ---> ~ZBN003E00!	3E
	Full ASCII ---? ~ZBN003F00!	3F
	Full ASCII ---@ ~ZBN004000!	40
	Full ASCII ---A ~ZBN004100!	41
	Full ASCII ---B ~ZBN004200!	42
	Full ASCII ---C ~ZBN004300!	43
	Full ASCII ---D ~ZBN004400!	44
	Full ASCII ---E ~ZBN004500!	45
	Full ASCII ---F ~ZBN004600!	46
	Full ASCII ---G ~ZBN004700!	47
	Full ASCII ---H ~ZBN004800!	48
	Full ASCII ---I ~ZBN004900!	49

	Full ASCII ---J ~ZBN004A00!	4A
	Full ASCII ---K ~ZBN004B00!	4B
	Full ASCII ---L ~ZBN004C00!	4C
	Full ASCII ---M ~ZBN004D00!	4D
	Full ASCII ---N ~ZBN004E00!	4E
	Full ASCII ---O ~ZBN004F00!	4F
	Full ASCII ---P ~ZBN005000!	50
	Full ASCII ---Q ~ZBN005100!	51
	Full ASCII ---R ~ZBN005200!	52
	Full ASCII ---S ~ZBN005300!	53
	Full ASCII ---T ~ZBN005400!	54
	Full ASCII ---U ~ZBN005500!	55

	Full ASCII ---V ~ZBN005600!	56
	Full ASCII ---W ~ZBN005700!	57
	Full ASCII ---X ~ZBN005800!	58
	Full ASCII ---Y ~ZBN005900!	59
	Full ASCII ---Z ~ZBN005A00!	5A
	Full ASCII ---[~ZBN005B00!	5B
	Full ASCII ---\ ~ZBN005C00!	5C
	Full ASCII ---] ~ZBN005D00!	5D
	Full ASCII ---^ ~ZBN005E00!	5E
	Full ASCII ---_ ~ZBN005F00!	5F
	Full ASCII ---` ~ZBN006000!	60
	Full ASCII ---a ~ZBN006100!	61

	Full ASCII ---b ~ZBN006200!	62
	Full ASCII ---c ~ZBN006300!	63
	Full ASCII ---d ~ZBN006400!	64
	Full ASCII ---e ~ZBN006500!	65
	Full ASCII ---f ~ZB006600!	66
	Full ASCII ---g ~ZBN006700!	67
	Full ASCII ---h ~ZBN006800!	68
	Full ASCII ---i ~ZBN006900!	69
	Full ASCII ---j ~ZBN006A00!	6A
	Full ASCII ---k ~ZBN006B00!	6B
	Full ASCII ---l ~ZBN006C00!	6C
	Full ASCII ---m ~ZBN006D00!	6D

	Full ASCII ---n ~ZBN006E00!	6E
	Full ASCII ---o ~ZBN006F00!	6F
	Full ASCII ---p ~ZBN007000!	70
	Full ASCII ---q ~ZBN007100!	71
	Full ASCII ---r ~ZBN007200!	72
	Full ASCII ---s ~ZBN007300!	73
	Full ASCII ---t ~ZBN007400!	74
	Full ASCII ---u ~ZBN007500!	75
	Full ASCII ---v ~ZBN007600!	76
	Full ASCII ---w ~ZBN007700!	77
	Full ASCII ---x ~ZBN007800!	78
	Full ASCII ---y ~ZBN007900!	79

	Full ASCII ---z ~ZBN007A00!	7A
	Full ASCII ---{ ~ZBN007B00!	7B
	Full ASCII --- ~ZBN007C00!	7C
	Full ASCII ---} ~ZBN007D00!	7D
	Full ASCII ---~ ~ZBN007E00!	7E
	Full ASCII ---DEL ~ZBN007F00!	7F

Appendix 1: USB Virtual COM Driver Installation

Contact your distributor to get the driver and follow the steps below to enable USB virtual COM port.

1. Connect the handheld scanner and the host (e.g. a PC) with a USB interface cable.
2. Enable USB virtual COM port with programming barcode from System Function Settings.
3. After the programming, the host would request driver installation. Browse your files to locate the driver and start installation.
4. The USB virtual COM port is ready for use after driver installation.

Appendix 2: Barcode Length Setting

Introduction

The length of a barcode is the number of characters it contains, including check digits. As listed in the Default Parameters section, each barcode type has different default length. You may change the setting by the following procedure.

To set up barcode length, the parameters to be determined are barcode type and the desired barcode length. Barcode length is consisted of 2 digits. For numbers smaller than 10, you need to add a "0" in the front.

Example

If the barcode length is 4 to 12 digits, the steps would be as below:

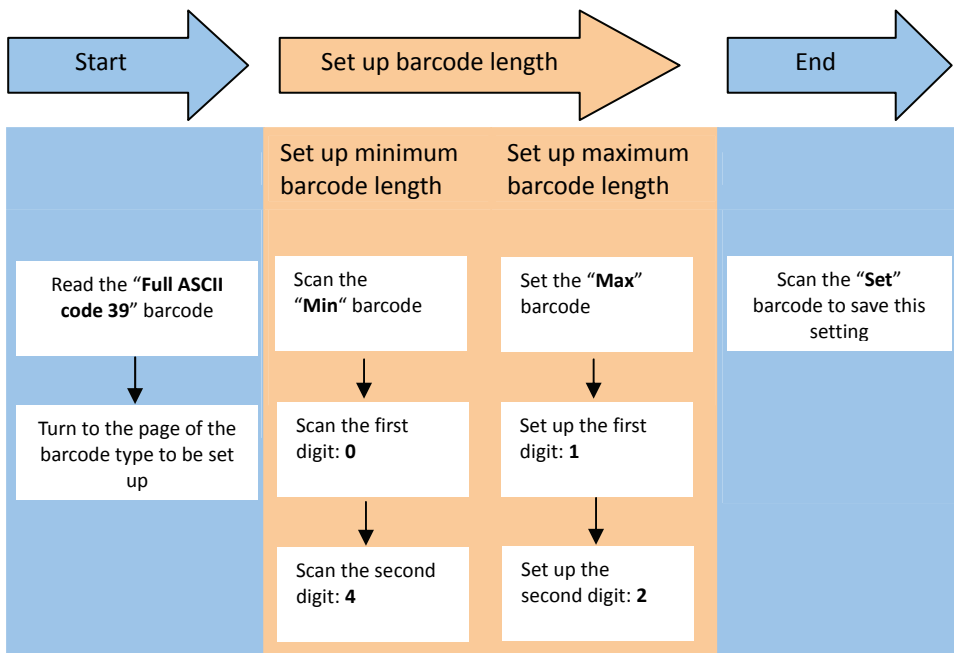

Use the ASCII table (Appendix 4) to set up barcode length. Be sure to enable the full ASCII code 39 option before you start and read the "Set" label to set your choice into memory.