



USER MANUAL

DT2 / DT4



USER MANUAL : DT2 / DT4
VERSION : Rev. B
ISSUE DATE : 2012.11.07
P/N : 920-014211-00

FCC COMPLIANCE STATEMENT FOR AMERICAN USERS

This equipment has been tested and found to comply with the limits for a CLASS A digital device, pursuant to Part 15 of the FCC Rules. These limits are designed to provide reasonable protection against harmful interference when the equipment is operated in a commercial environment. This equipment generates, uses, and can radiate radio frequency energy and, if not installed and used in accordance with the instructions, may cause harmful interference to radio communications. Operation of this equipment in a residential area is likely to cause harmful interference in which case the user will be required to correct the interference at own expense.

EMS AND EMI COMPLIANCE STATEMENT FOR EUROPEAN USERS

This equipment has been tested and passed with the requirements relating to electromagnetic compatibility based on the standards EN 55022:1998+A1:2000+A2:2003, CISPR 22, Class A EN 55024:1998+A1:2001+A2:2003, IEC 61000-4 Series EN 61000-3-2 / 2000 & EN 61000-3-3 / 1995. The equipment also tested and passed in accordance with the European Standard EN55022 for the both Radiated and Conducted emissions limits.

DT SERIES TO WHICH THIS DECLARATION RELATES IS IN CONFORMITY WITH THE FOLLOWING STANDARDS

EN55022 : 1998, CISPR 22, Class A / EN55024 : 1998 / IEC 61000-4 Serial / EN61000-3-2 : 2000 / EN 6100-3-3 : 1995 / CFR 47, Part 15/CISPR 22 3rd Edition : 1997, Class A / ANSI C63.4 : 2001 / CNS 13438 / IEC60950-1 : 2005 (EN 60950-1 : 2006+A11 : 2009) / GB4943 : 2001 / GB9254 : 1998 / GB17625.1 : 2003 / EN60950-1 : 2001

CAUTION

- Danger of explosion if battery is incorrectly replaced. Replace only with the equivalent type recommended by the manufacturer.
- Dispose of used batteries according to the manufacturer's instructions.
- Only use with designated power supply adapter model.
- Changes or modifications not expressly approved by the party responsible for compliance could void the user's authority to operate the equipment.

Safety instructions

Please read the following instructions carefully.

1. Keep the equipment away from humidity.
2. Before you connect the equipment to the power outlet, please check the voltage of the power source.
3. Make sure the printer is off before plugging the power connector into the power jack.
4. It is recommended that you connect the printer to a surge protector to prevent possible transient overvoltage damage.
5. Be careful not to get liquid on the equipment to avoid electrical shock.
6. For safety and warranty reasons, ONLY qualified service personnel should open the equipment.
7. Do not repair or adjust energized equipment under any circumstances.

1. BARCODE PRINTER.....	1
1-1. Box content	1
1-2. Specifications	1
1-3. Getting to know your printer.....	3
2. PRINTER SETUP	6
2-1. Loading the label roll.....	6
2-2. Installing the label roll holder	8
2-3. Connecting the printer to the host computer	9
2-4. Installing the driver	10
3. OPERATOR PANEL	12
3-1. FEED button	12
3-2. LED status	12
3-3. Label size calibration	12
3-4. Self test	13
3-5. Error alerts	14
4. NETSETTING FOR ETHERNET	15
4-1. Installing the NetSetting software	15
4-2. The interface of NetSetting	16
5. ACCESSORIES	23
5-1. Installing the label dispenser	23
5-2. Installing the cutter	26
6. MAINTENANCE AND ADJUSTMENT	29
6-1. Cleaning the print head.....	29
6-2. Adjusting the cutter	29
6-3. Labels with black marks.....	30
6-4. Troubleshooting	31
APPENDIX	32
A. Printer interfaces.....	32

1. Barcode printer

1-1. Box content

Please check that all of the following items are included with your printer:

- ◆ Barcode printer
- ◆ Power cord
- ◆ AC adapter
- ◆ USB cable
- ◆ Label stock
- ◆ Quick reference guide
- ◆ CD (with QLabel label software / user manual)



DT2



DT4

1-2. Specifications

Model	DT2	DT4
Print Method	Direct Thermal	
Resolution	203 dpi (8 dot/mm)	
Print Speed	4 IPS (102 mm/s)	
Print Width	2.12" (54 mm)	4.25" (108 mm)
Print Length	Min. 0.16" (4 mm)** ; Max. 68" (1727 mm)	
Processor	32 Bit RISC CPU	
Memory	4MB Flash (2MB for user storage) ; 16MB SDRAM	8MB Flash (4MB for user storage) ; 16MB SDRAM
Sensor Type	Adjustable reflective sensor. Fixed transmissive sensor, central aligned	
Media	Types: Continuous form, gap labels, black mark sensing, and punched hole; label length set by auto sensing or programming	
	Width: 0.6" (15 mm) Min. - 2.36" (60 mm) Max. Thickness: 0.003" (0.06 mm) Min. - 0.008" (0.20 mm) Max. Label roll diameter: Max. 5" (127 mm) Core diameter: 1", 1.5" (25.4 mm, 38.1 mm)	Width: 1" (25.4 mm) Min. - 4.64" (118 mm) Max. Thickness: 0.003" (0.06 mm) Min. - 0.008" (0.20 mm) Max. Label roll diameter: Max. 5" (127 mm) Core diameter: 1", 1.5" (25.4 mm, 38.1 mm)
Printer Language	EZPL, GEPL, GZPL, auto switch	
Software	Label design software: GoLabel (for EZPL only) Driver: Windows 2000, XP, Vista, 7, Windows Server 2003 & 2008 DLL: Windows 2000, XP and Vista	

Resident Fonts	Bitmap fonts: 6, 8, 10, 12, 14, 18, 24, 30, 16X26 and OCR A & B Bitmap fonts 90°, 180°, 270° rotatable, single characters 90°, 180°, 270° rotatable Bitmap fonts 8 times expandable in horizontal and vertical directions Scalable fonts 90°, 180°, 270° rotatable	
Download Fonts	Bitmap fonts 90°, 180°, 270° rotatable, single characters 90°, 180°, 270° rotatable Asian fonts 90°, 180°, 270° rotatable and 8 times expandable in horizontal and vertical directions Scalable fonts 90°, 180°, 270° rotatable	
Barcodes	1-D Bar codes: Code 39, Code 93, EAN 8 /13 (add on 2 & 5), UPC A/E (add on 2 & 5), I 2 of 5 & I 2 of 5 with Shipping Bearer Bars, Codabar, Code 128 (subset A, B, C), EAN 128, RPS 128, UCC 128, UCC/EAN-128 K-Mart, Random Weight, Post NET, ITF 14, China Postal Code, HIBC, MSI, Plessey, Telepen, FIM and GS1 DataBar	
	2-D Bar codes: PDF417, Datamatrix code, MaxiCode, QR code, Micro PDF417, Micro QR code and Aztec code	
Code Pages	CODEPAGE 437, 850, 851, 852, 855, 857, 860, 861, 862, 863, 865, 866, 869, 737 WINDOWS 1250, 1251, 1252, 1253, 1254, 1255, 1257 Unicode (UTF8, UTF16)	
Graphics	Resident graphic file types are BMP and PCX, other graphic formats are downloadable from the software	
Interfaces	USB Device (B-Type) Serial port: RS-232 (DB-9) IEEE 802.3 10/100Base-Tx Ethernet port (RJ-45)	
Control Panel	One Tri-color LED: Power (Green, Orange and Red) Control key: FEED	
Real Time Clock	Standard	
Power	Auto Switching 100-240VAC, 50-60Hz	
Environment	Operation temperature: 41°F to 104°F (5°C to 40°C) Storage temperature: -4°F to 122°F (-20°C to 50°C)	
Humidity	Operation: 30-85%, non-condensing. Storage: 10-90%, non-condensing.	
Agency Approvals	CE(EMC), FCC Class A, CB, cUL, CCC	
Dimension	Length: 8.58" (218 mm)	Length: 8.58" (218 mm)
	Height: 6.77" (172 mm)	Height: 6.53" (166 mm)
Weight	Width: 3.94" (100 mm)	Width: 6.61" (168 mm)
	2.65 lbs (1.2Kg) ,excluding consumables	3.3 lbs (1.5Kg) ,excluding consumables
Options	Cutter Module Label Dispenser External label roll holder for 10" (250 mm) O.D. label rolls External label rewinder	

* Specifications are subject to change without notice. All company and/or product names are trademarks and/or registered trademarks of their respective owners.

** Minimum print height and maximum print speed specification compliance can be dependent on non-standard material variables such as label type, thickness, spacing, liner construction, etc. Godex is pleased to test non-standard materials for minimum print height and maximum print speed capability.

1-3. Getting to know your printer

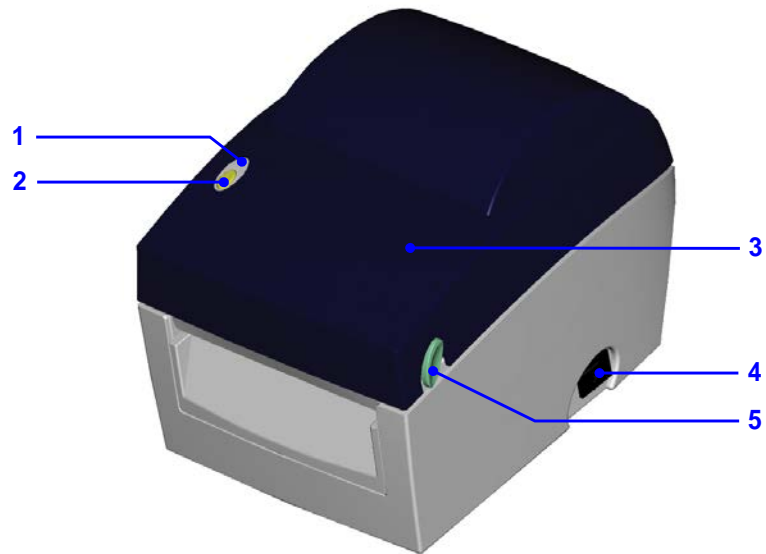

1.	LED indicator
2.	FEED function button
3.	Printer cover
4.	On/off switch
5.	Release buttons

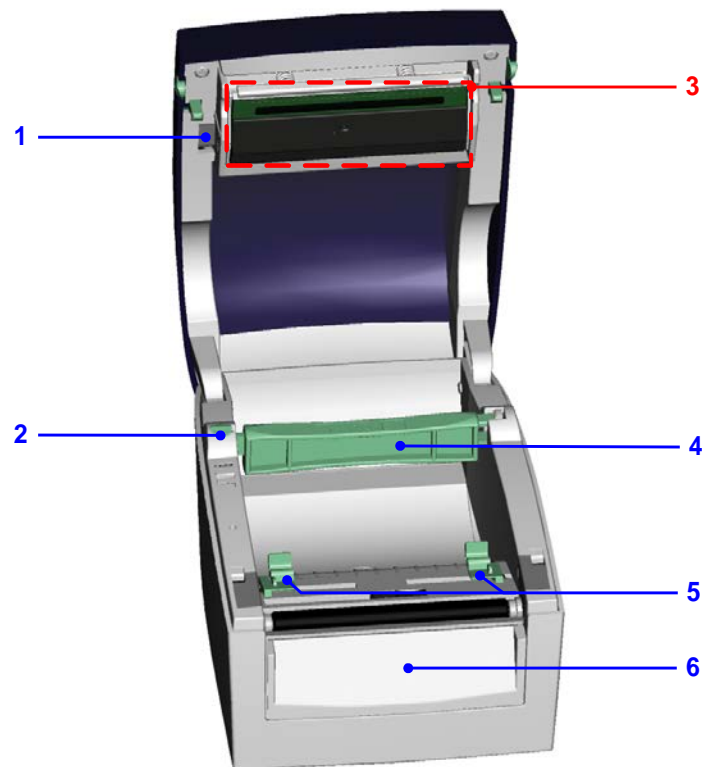

1.	Print head release lever
2.	Label roll holder
3.	Print mechanism
4.	Label supply hub
5.	Label guides
6.	Front cover

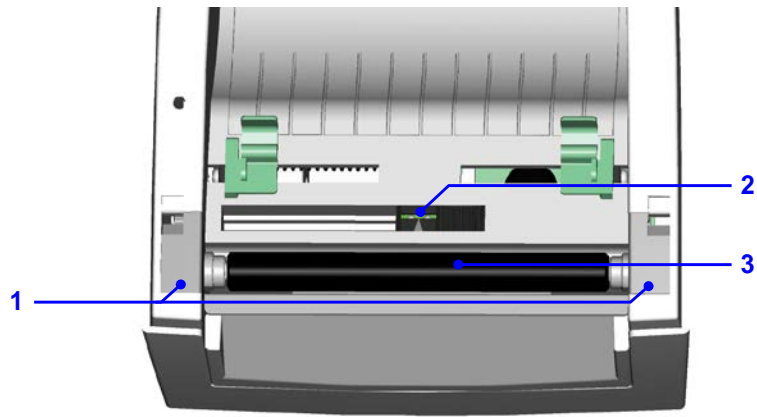

1.	Platen cover
2.	Label sensor
3.	Platen roller

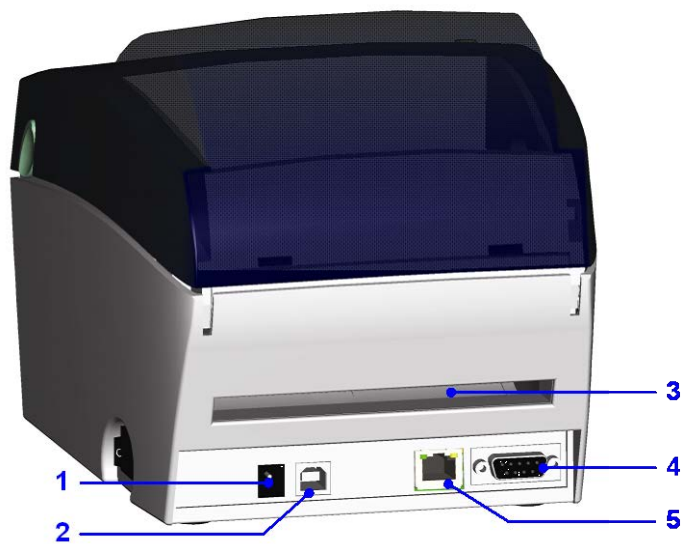

1.	Power jack
2.	USB port
3.	Feed slot for continuous labels
4.	Serial port (RS-232)
5.	Ethernet port

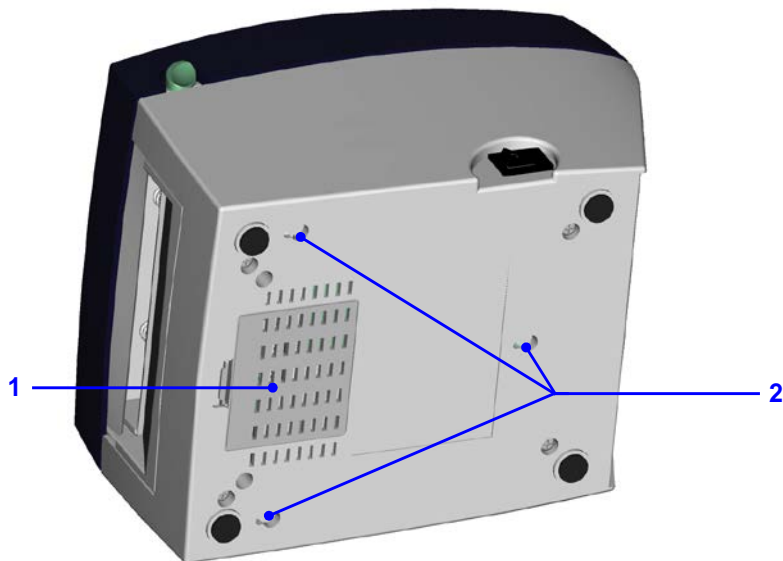

1.	Cover on bottom of printer
2.	Mounting points

2. Printer setup

2-1. Loading the label roll

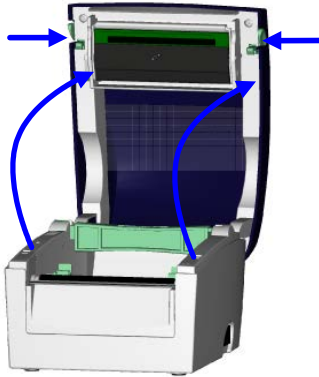
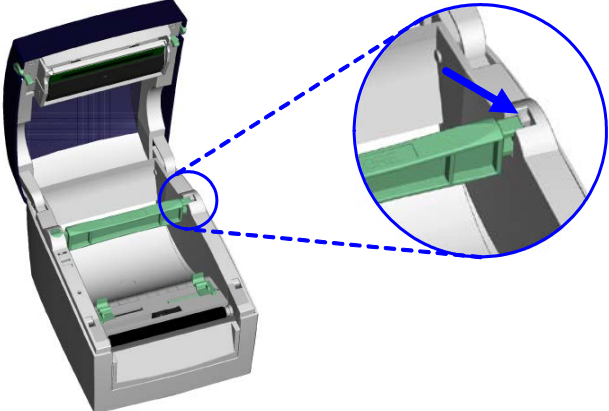
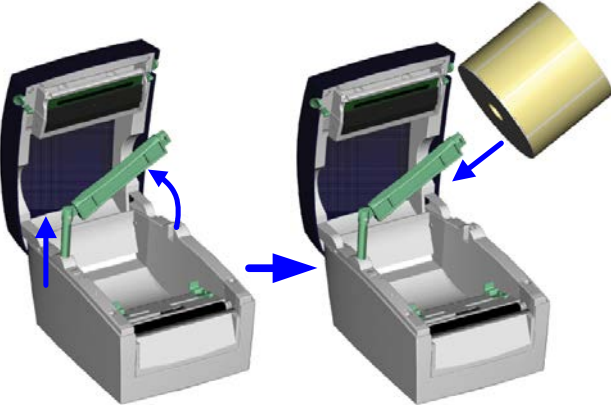
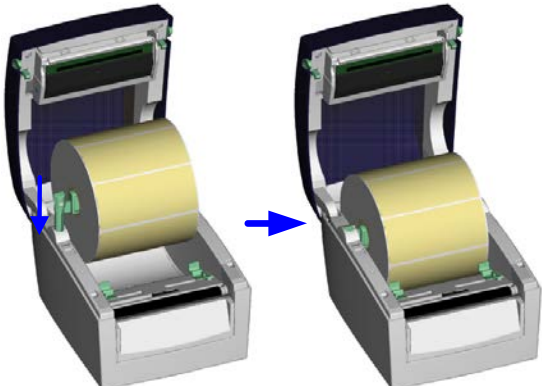
<p>1. Place the printer on a flat surface and open the printer cover.</p>	
<p>2. Release the label supply hub.</p>	
<p>3. Lift the label roll holder and pull it out as far as possible.</p> <p>4. Install the label roll on the label supply hub.</p>	
<p>5. Now press the label roll holder down until it clicks into place.</p> <p>6. Return the label roll holder to its original position.</p>	

7. Pass the label under the paper guides and pull it forward.

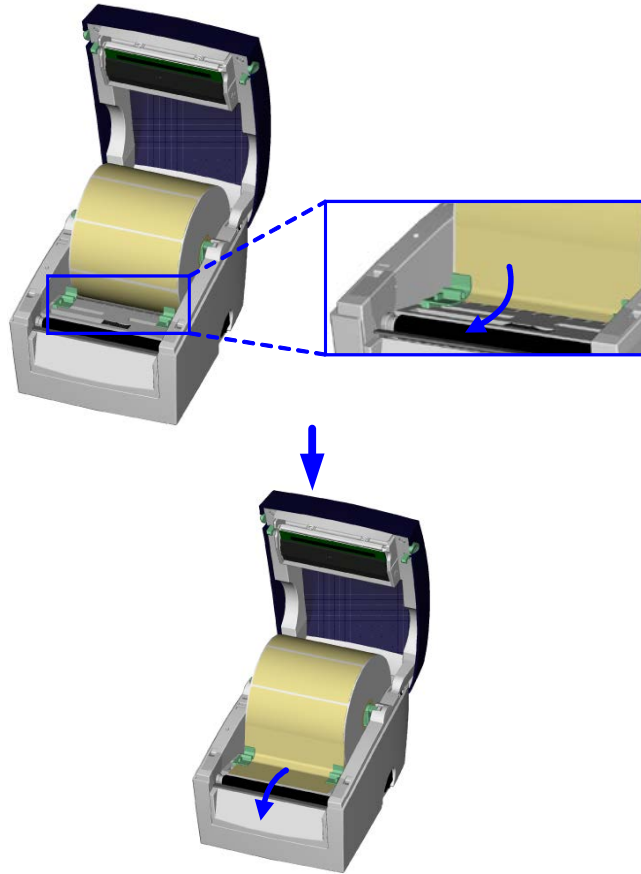

8. Adjust the paper guides to the width of the label liner.

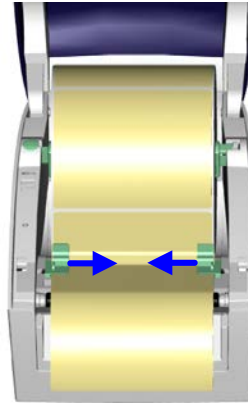

9. Close the printer cover to finish loading the labels.

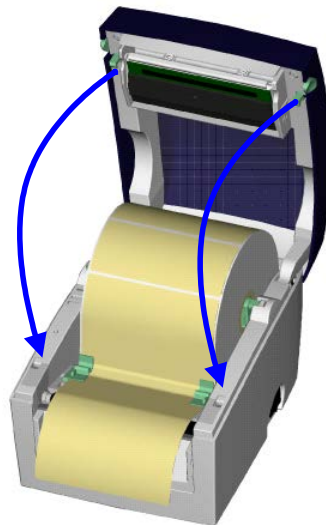

2-2. Installing the label roll holder

1. Pull the label roll holder out as far as it will go.
2. Fold out the label supply hub as shown in the illustration.
3. Now rotate the label roll holder to return the label supply hub to its original position. Press down the label supply hub until it clicks into place.

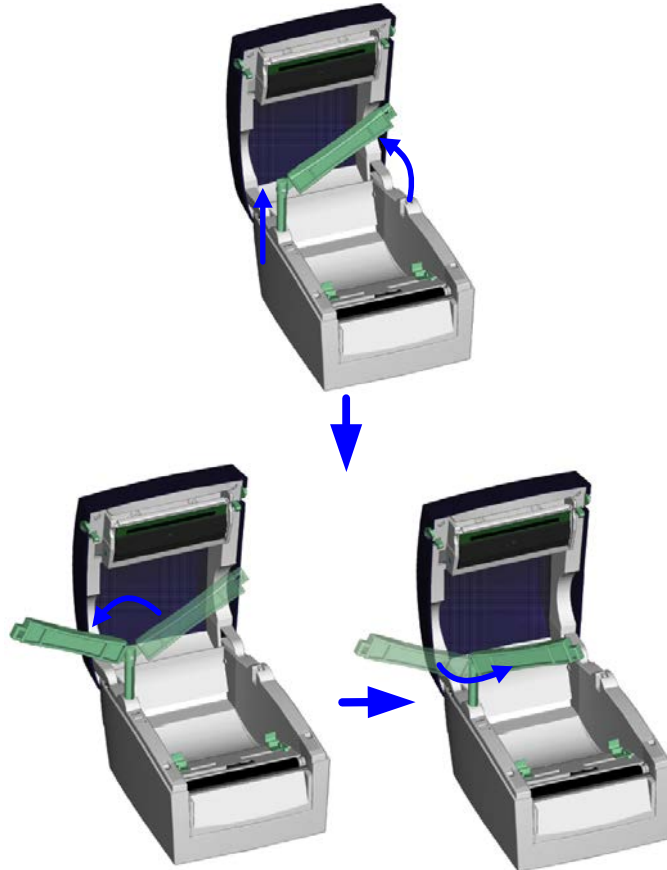

- A. To load label stock with a 1" core, the locking notch must be at the top of the label supply hub.

1" core

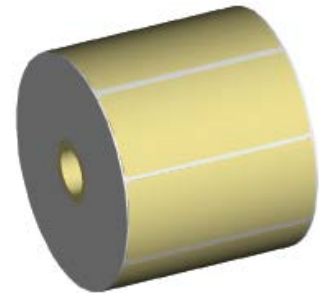
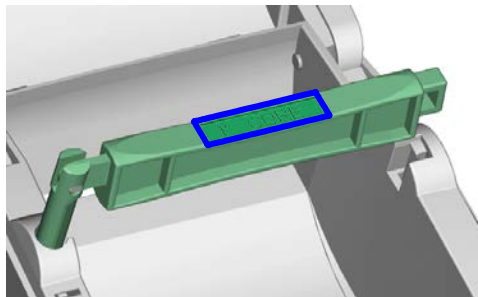

- B. To load label stock with a 1.5" core, the locking notch must be at the bottom of the label supply hub.

[Note]

The hub is also marked on both sides to indicate the core size, as shown in the illustration.

1.5" core

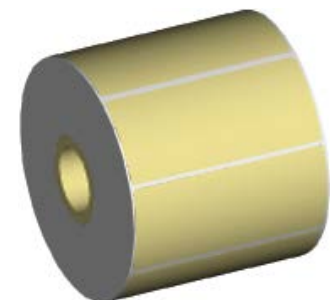
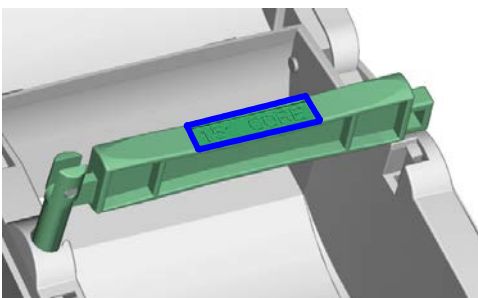



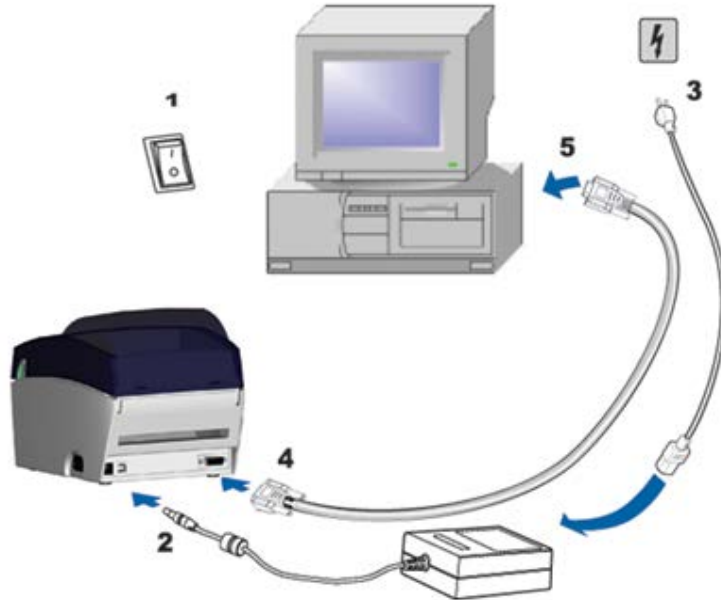

2-3. Connecting the printer to the host computer

1. Please make sure that the printer is switched off.
2. Connect the power cord to the power supply and to the AC adapter, then connect the adapter to the printer.
3. Connect the printer with the host computer via the USB port or serial port.
4. Switch on the printer. The LED indicator should light up.

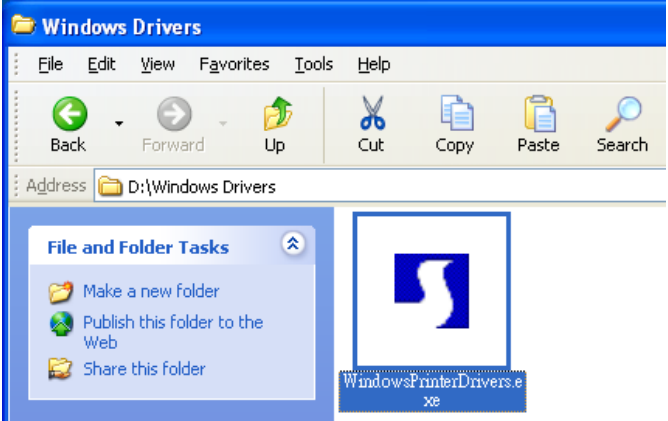

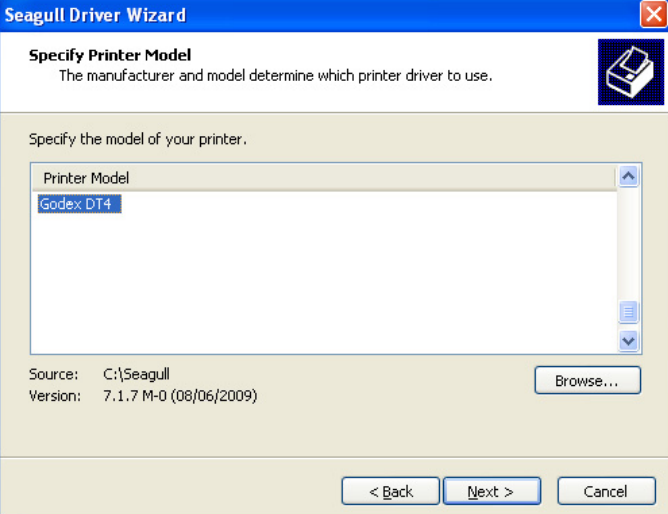
2-4. Installing the driver

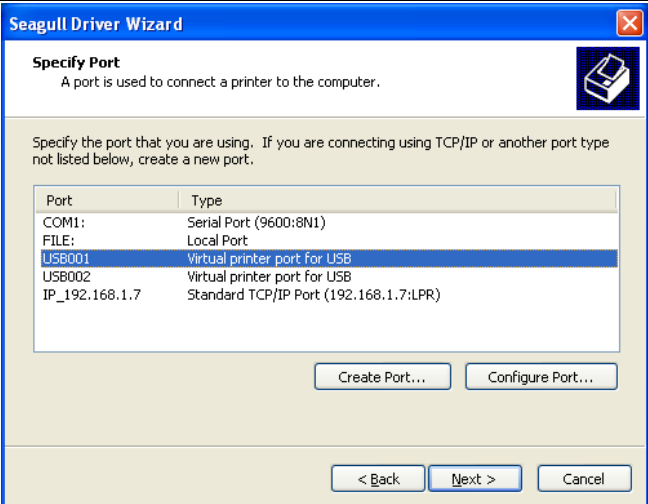
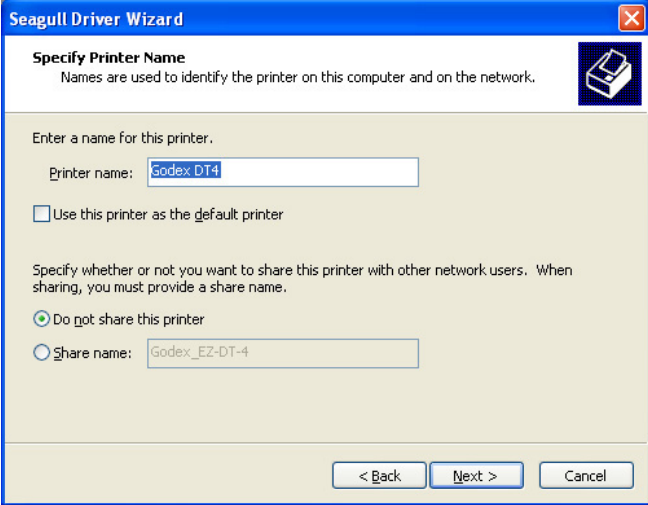
<ol style="list-style-type: none"> 1. Insert the product CD in the CD/DVD drive of the host computer and open the "Windows Drivers" folder on the CD. 2. Execute the file with the same icon as the file selected in the illustration on the right. 	
<ol style="list-style-type: none"> 3. Follow the instructions in the installation wizard. 4. Select "Install printer drivers" to start with the driver installation. 	
<ol style="list-style-type: none"> 5. Specify your printer model and continue with the installation. 	

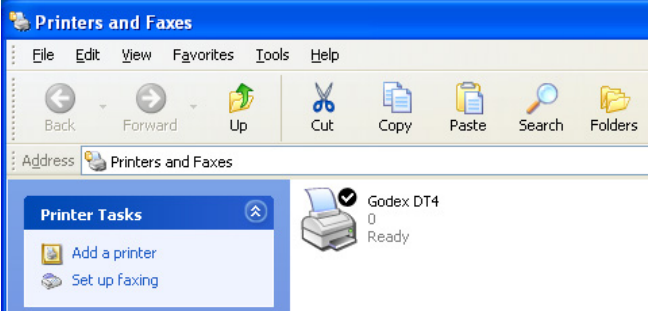
<p>6. Specify the port used to connect the printer to the host computer.</p>	
<p>7. Enter a printer name. The printer will be listed under this name in the "Printers and Faxes" folder.</p> <p>8. Specify whether or not you want to share the printer with other network users and assign the printer a share name.</p>	
<p>9. When you have configured all the settings, a summary of the printer settings is displayed, which you should check.</p> <p>10. If all settings are correct, click Finish to start copying the driver files.</p>	
<p>11. Once copying is complete, the new printer should be visible in the "Printers and Faxes" folder.</p>	

3. Operator panel

3-1. FEED button

When you press the FEED button, the printer moves the label to the defined stop position. If you are using continuous labels, pressing the FEED button will move label stock until you release the button again. If you are using individual labels, pressing the FEED button will move only one label. If the label does not stop at the correct position, you need to run the auto-detection function on the label stock (see Section 3-3).

3-2. LED status

Press the FEED button and keep it pressed, then switch on the printer. You will hear two beeps and the LED lights up red. Release the FEED button. The printer will now automatically measure the label size (see Section 4-3.) and then print a test page (see Section 4-4.)

	LED indicator	Status	Description
	Green	Standby mode	The printer is ready for operation.
	Red (flashing)	Error mode	The printer has detected an error. (see Section 3-5. Error alerts)

3-3. Label size calibration

The printer can automatically detect and store label height. That means the host computer does not need to transmit the label height to the printer.

1. Check that the label sensor is positioned correctly.
2. Check that the label stock is loaded correctly.
3. Switch off the printer.
4. Switch on the printer, keeping the FEED button pressed. When the LED starts to flash red, release the FEED button. The printer will now measure the label stock and store the label height.
5. Once the printer has successfully measured the label stock, it will print a self-test label.

3-4. Self test

The self-test function helps you find out whether the printer is functioning normally. The printer prints the following test page:

Model & Version	DT4 : GX.XXX
USB ID setting	USB S/N : 12345678
Serial port setting	Serial port : 96,N,8,1
MAC address of Ethernet port	MAC Addr: xx-xx-xx-xx-xx-xx
IP protocol setting	DHCP Enable
IP address of Ethernet port	IP xxx.xxx.xxx.xxx
Gateway setting	Gateway xxx.xxx.xxx.xxx
Netmask setting	Sub-Mask xxx.xxx.xxx.xxx
	#####
Number of DRAM installed	1 DRAM installed
Image buffer size	Image buffer size : 1500 KB
Number of forms	0000 FORM(S) IN MEMORY
Number of graphics	0000 GRAPHIC(S) IN MEMORY
Number of fonts	000 FONT(S) IN MEMORY
Number of Asian fonts	000 ASIAN FONT(S) IN MEMORY
Number of Databases	000 DATABASE(S) IN MEMORY
Number of Scalable fonts	000 TTF(S) IN MEMORY
Free memory size	4073 KB FREE MEMORY
Speed, Density, Ref. Point, Print direction	^S4 ^H8 ^R000 ~R200
Label width, Form length, Stop position	^W102 ^Q100,3 ^E18
Cutter, Label Dispenser, Mode	Option : ^D0 ^O0 ^AD
Sensor Setting	Reflective AD: 1.96 2.84 2.49 [0.88_23]
Code Page	Code Page: 850
Printer is on factory default	Default state= Yes

【Note】

For more information about advance settings, such as “Sensor switch” or “Dump Mode”, please refer to Programmer’s manual.

3-5. Error alerts

LED indicator	Beeps	Description	Solution
Red	2 x 4 beeps	The print mechanism is not correctly closed.	Open the print mechanism and close it again.
Red (flashing)	None	High temperature at the print head.	Once the print head has cooled down, the printer switches to standby mode.
Red	2 x 2 beeps	No paper is detected.	Make sure that the label sensor is positioned correctly. If the sensor still does not detect the paper, run the auto-detection function again.
		The paper is finished.	Replace the label roll.
Red	2 x 2 beeps	Paper feed problem.	Possible reasons: the print medium has become trapped around the rubber roll; the sensor cannot detect a gap or black mark between the labels; there is no paper. Please reset the sensor.
Red	2 x 2 beeps	The memory is full. The printer prints the message "Memory full".	Delete unnecessary data or install additional memory.
Red	2 x 2 beeps	Unable to find file. The printer prints the message "Filename cannot be found".	Use the "~X4" command to print all files. Then check whether the files exist and whether the names are correct.
Red	2 x 2 beeps	A file of the same name already exists. The printer prints the message "Filename is repeated".	Change the name of the file and try storing it again.

4. NetSetting for Ethernet

4-1. Installing the NetSetting software

The NetSetting software is used to manage the network configurations when connecting the printer via Ethernet port. It is available on product CD or can be downloaded from official website. To install the NetSetting, please follow below steps.

STEP-01 Insert the product CD in the CD/DVD drive of the host computer and open the "Ethernet" folder on the CD.

STEP-02 Select the icon for the NetSetting installation file and click it to start the installation.

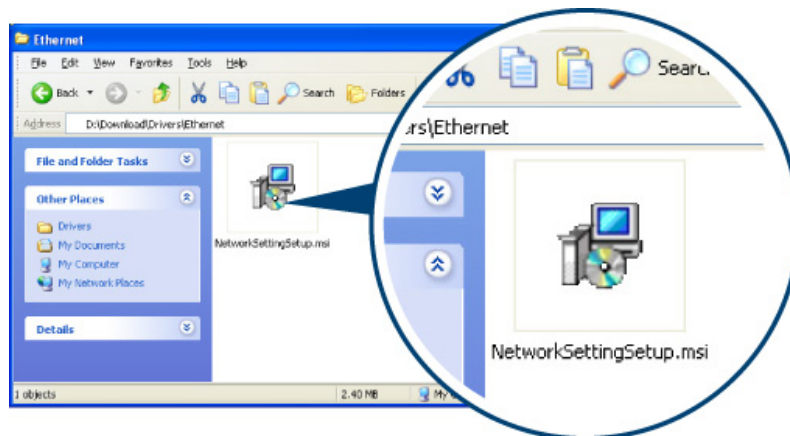

STEP-03 Follow the instructions on the screen. The Setup Wizard guides you through the installation procedure.

STEP-04 Specify the "Installation Folder".

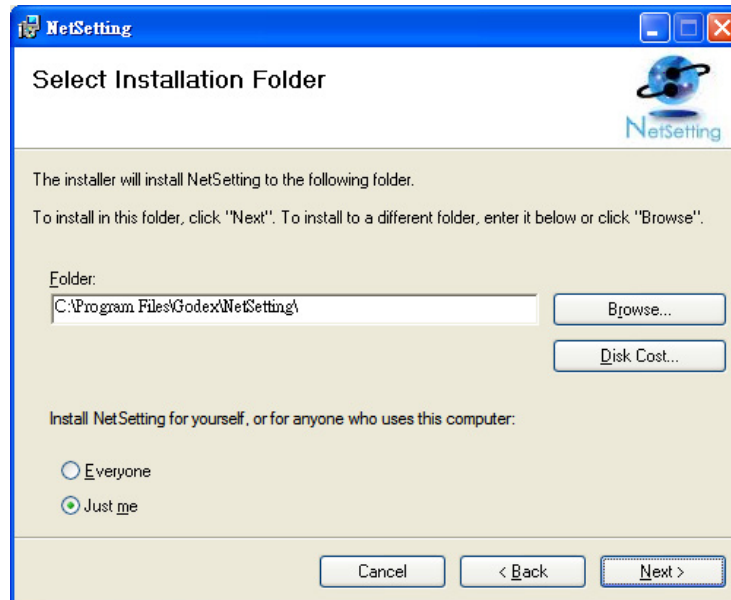

STEP-05 Click "Next" to start the installation.

STEP-06 Once the installation is completed; you will see the NetSetting icon on your desktop.

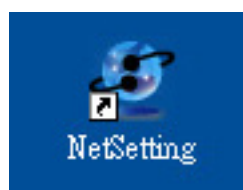

4-2. The interface of NetSetting

Click the NetSetting icon to start the program; you will see the start page as below. The start page will display the basic information of connected printer and your PC.

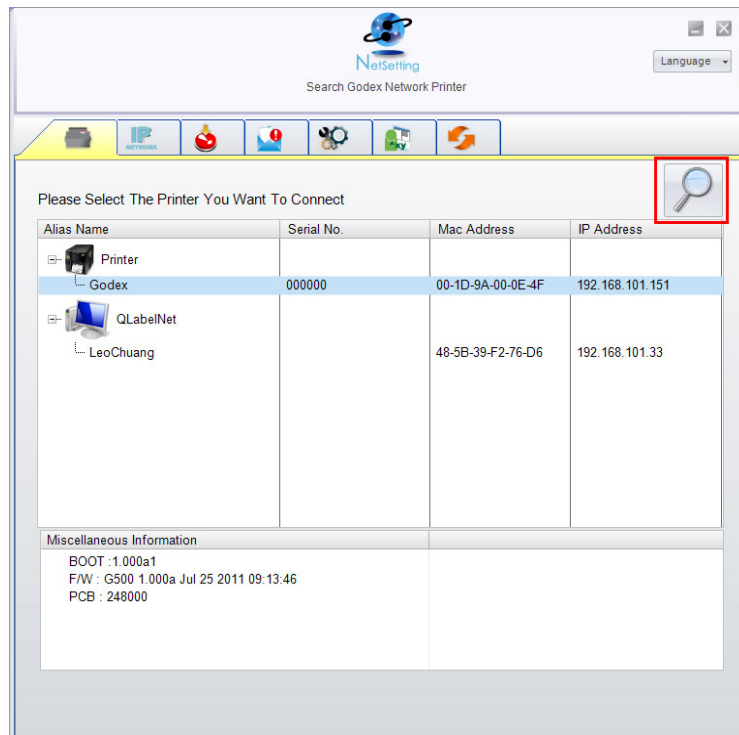

Click the magnifier icon to search the Godex printers which are connected via Ethernet port in your network environment. Once a connected Godex printer is detected, it will be listed on the start page.

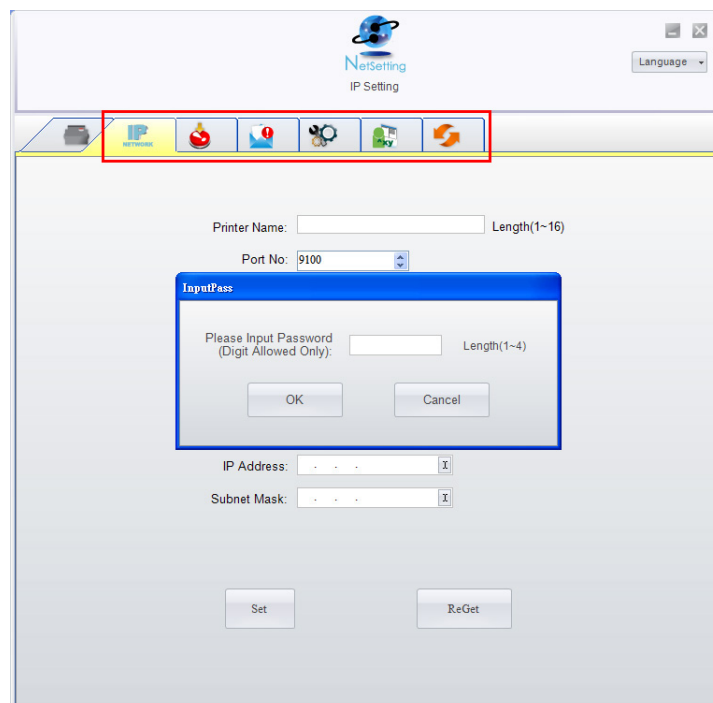

There are six tabs on the top of interface which can configure different types of network settings. But for the data security reason, you need correct password to enter the configuration pages.

【Note】

The default password is "1111", you can change the password later from the "IP Setting" tab.

IP Setting

The IP Setting tab can change the printer name, Port number, Gateway setting and the password for configuring the printer. You can also set the printer's IP address either by DHCP or by Static IP.

The screenshot shows the 'NetSetting IP Setting' window. At the top, there is a logo for 'NetSetting' and a 'Language' dropdown menu. Below the logo is a navigation bar with several icons, including a printer, a network icon, a power button, a mail icon, a gear icon, a printer icon, and a refresh icon. The main content area contains the following fields and options:

- Printer Name: Length(1~16)
- Port No:
- Default Gateway:
- Password: Length(1~4)
- Get IP From DHCP Server
- Static IP
- IP Address:
- Subnet Mask:

At the bottom of the window, there are two buttons: 'Set' and 'ReGet'.

You can press “Set” button to apply the settings and “ReGet” button to refresh the setting values.

【Note】

To fully benefit from the NetSetting software, you should be familiar with basic networking principles. Please contact your network administrator for related network setting information.

Alert Path Setting

NetSetting will send the alert messages to designated mail account when the error happened on printer. The alert messages are sent by SMTP (Simple Mail Transfer Protocol) or SNMP (Simple Network Management Protocol). You can set or change the configurations of SMTP and SNMP on this "Alert Path Setting" tab.

NetSetting
Alert Path Setting

Language

SMTP Notification Enable

Login Account: Length(1~64)

Login Password: Length(1~16)

Server IP Address: xxx.xxx.xxx.xxx

Mail Subject: Length(1~60)

Mail From Address: Length(1~32)

Mail To Address: Length(1~32)

Duration Cycle: 0 ~ 168 Hours

Event Counter: 1 ~ 100

SNMP Notification Enable

SNMP Community: Length(1~16)

SNMP Trap Community: Length(1~16)

Trap IP Address: xxx.xxx.xxx.xxx

You can press "Set" button to apply the settings and "ReGet" button to refresh the setting values.

Alert Message Setting

For the alert message notification function, you can decide which error cases need to be sent out to the operator. Moreover, the alert messages can be set to be sent by SMTP, SNMP or both.

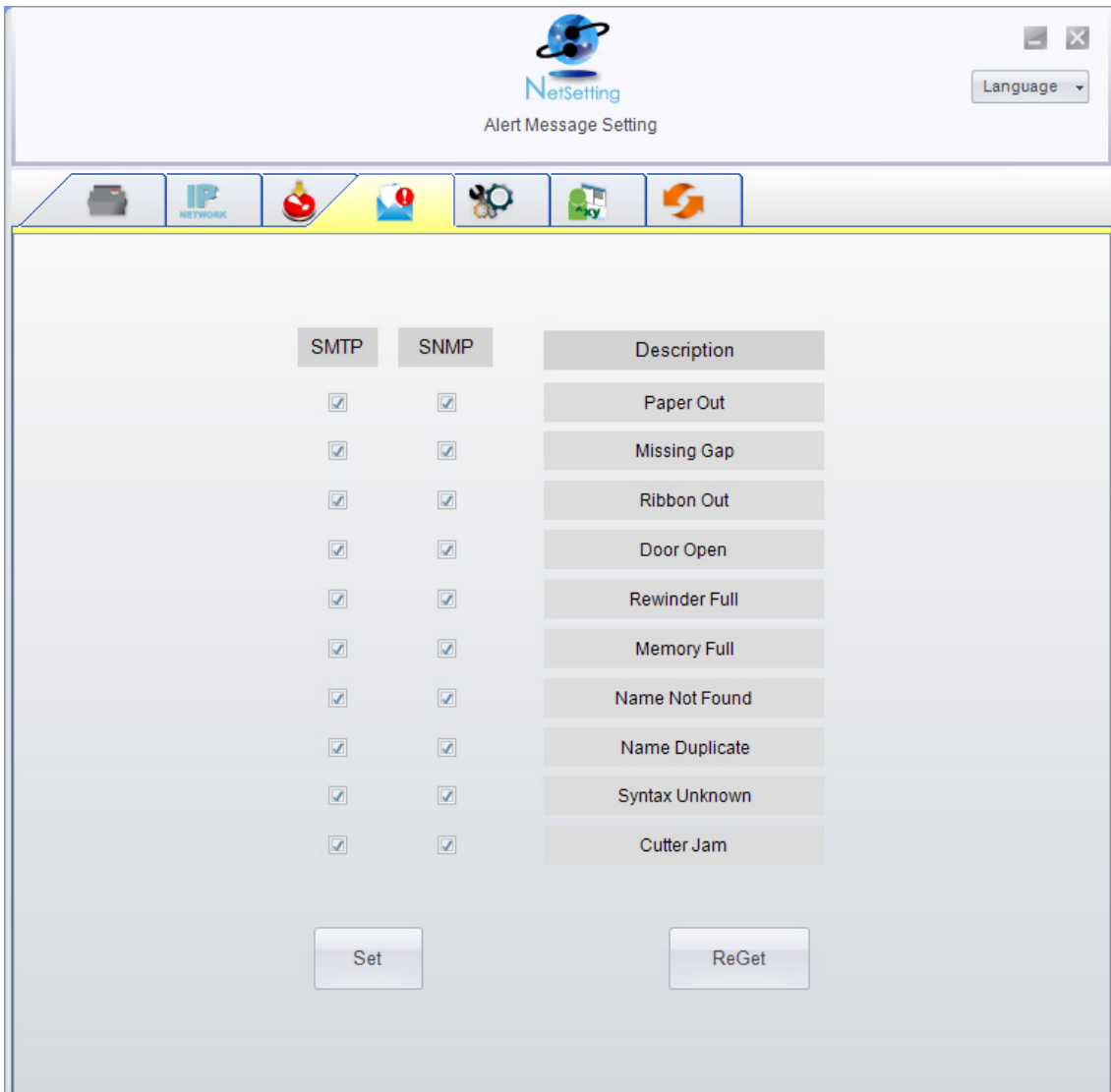

You can press “Set” button to apply the settings and “ReGet” button to refresh the setting values.

Printer Configuration

Set or change the configurations of connected printer. Most of key settings for the printer operation can be done by this setting page.

The screenshot shows the 'Printer Configuration' window. At the top, there is a 'Language' dropdown menu. Below it is a navigation bar with icons for printer, IP network, power, mail, settings, and refresh. The main content area is titled 'Printer Setup' and contains several settings:

Printer Model	Resolution	Speed	Darkness	Stripper/Applicator	Labels per Cut	Printing Mode
G500	203	4	10	0 (None)	0	Thermal Transf

Below this are two sections:

PC Com Port Settings

Baud Rate	9600
Parity	None
Data Bits	8
Stop Bits	1

Miscellaneous

LCD Language	Sensing Mode
Keyboard Language	2 - Automatic
Code Page	Smart Backfeed
Code Page 850	OFF
Buzzer	Top Of Form
ON	ON

At the bottom are 'Set' and 'ReGet' buttons.

You can press “Set” button to apply the settings and “ReGet” button to refresh the setting values.

User Command

The "User Command" tab provides a communication interface for operator to control the printer. Input printer commands in "Input Command" window and press "Send Command" button, the commands will be sent to the printer. For some commands that will return response message, the message will be displayed in "Output Message" window.

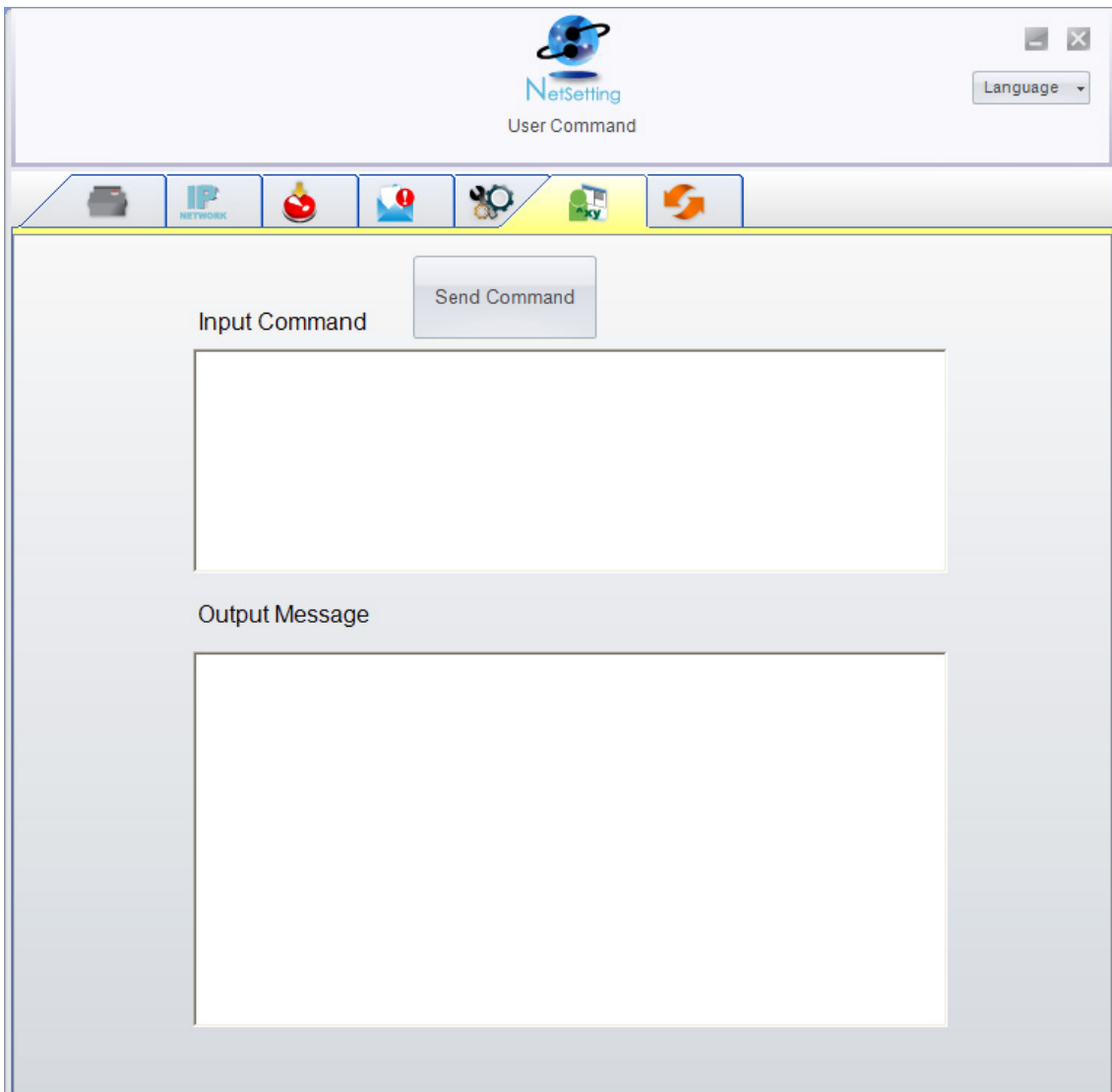

You can press "Send Command" button to send printer commands via Ethernet port and control the printer remotely.

Firmware Download

On “Firmware Download” tab, the current version of printer firmware will be showed on the screen. If you need to update the printer firmware, just specify the file location of firmware file and press “Start Download Firmware” button. The printer firmware then can be updated remotely.

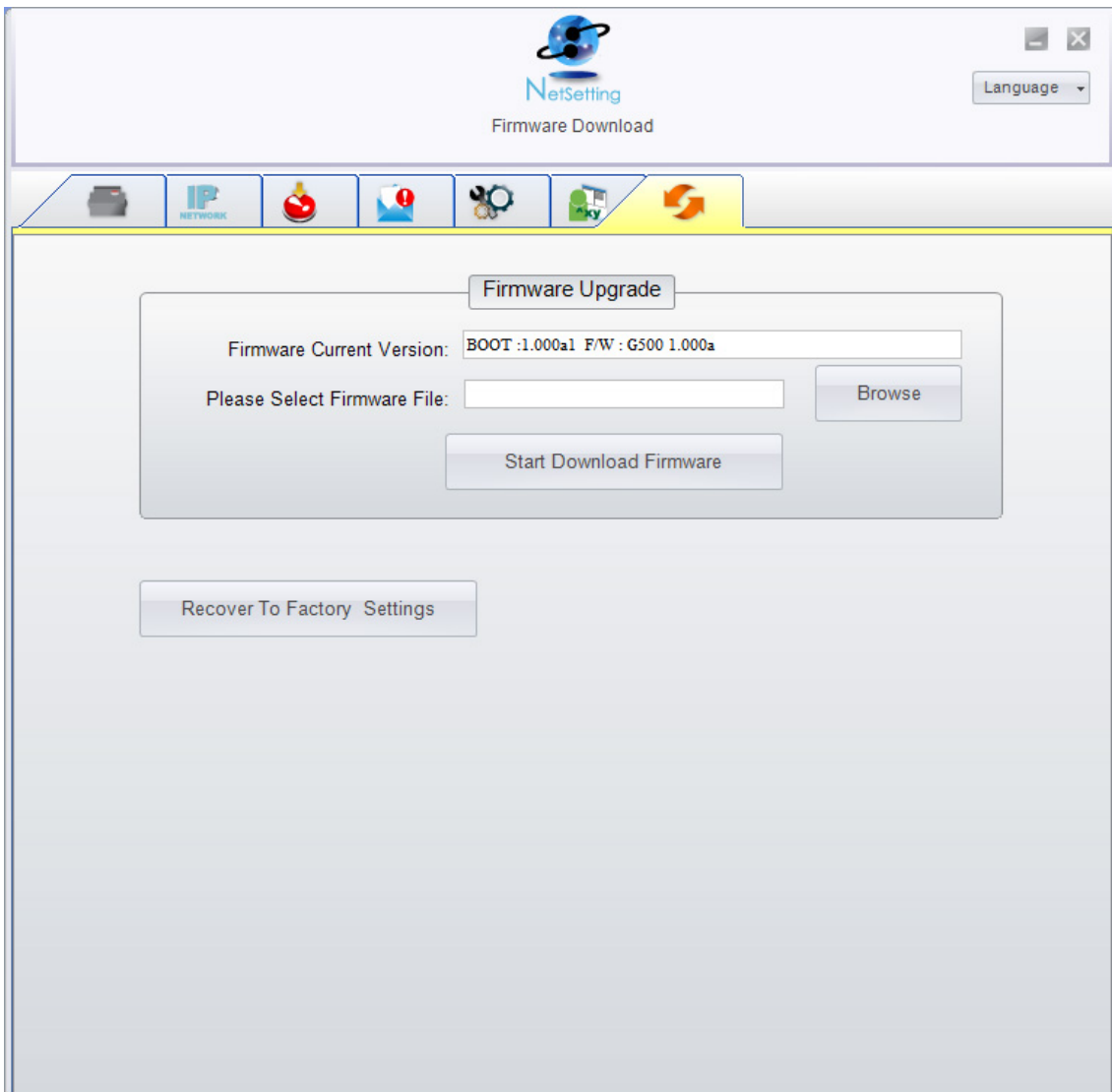

The screenshot shows a web browser window titled "Firmware Download" with the NetSetting logo. The interface includes a navigation bar with icons for printer, IP network, status, alerts, settings, and a refresh button. The main content area is titled "Firmware Upgrade" and contains the following elements:

- A text field for "Firmware Current Version" displaying "BOOT :1.000a1 F/W : G500 1.000a".
- A label "Please Select Firmware File:" followed by a text input field and a "Browse" button.
- A "Start Download Firmware" button.
- A "Recover To Factory Settings" button located below the main form.

In addition to the firmware update, you can press “Recover To Factory Settings” button to restore the printer configurations back to factory default.

5. Accessories

5-1. Installing the label dispenser

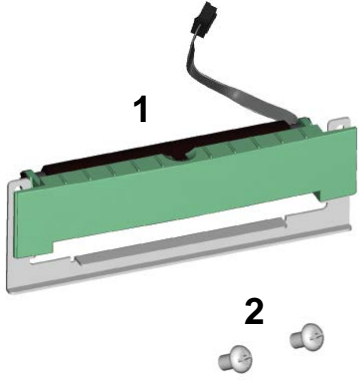
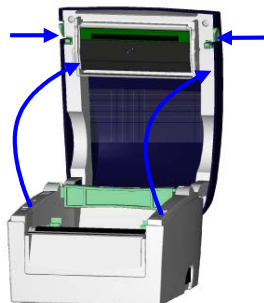
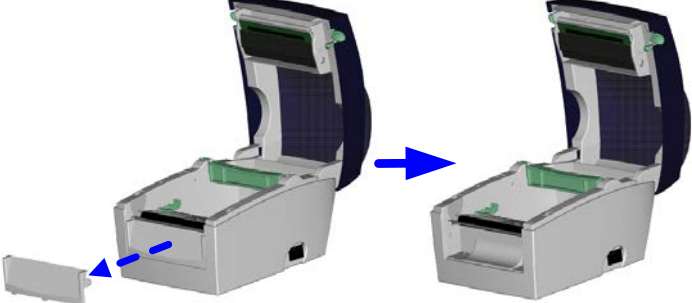
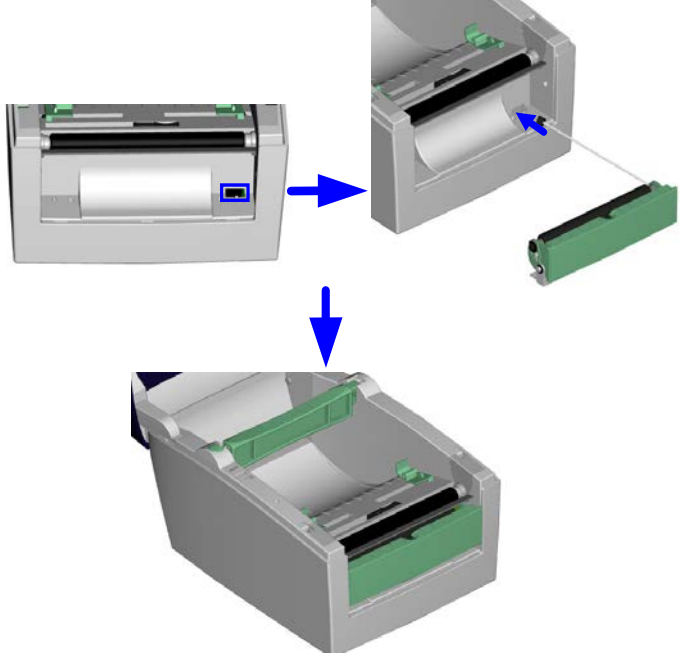

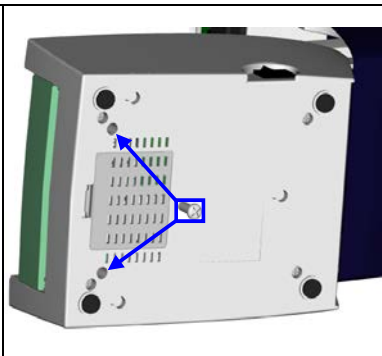
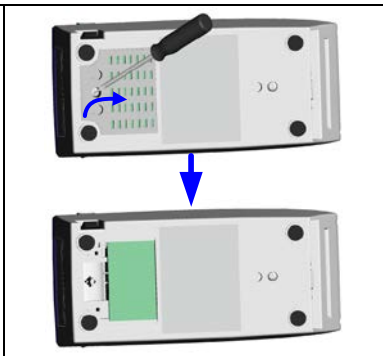
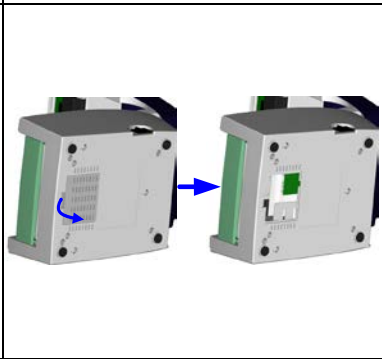
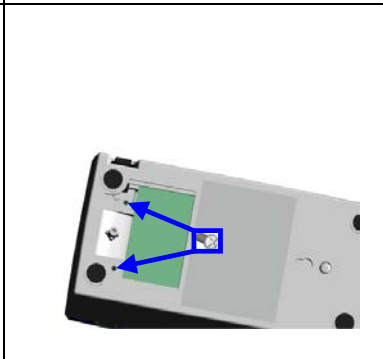
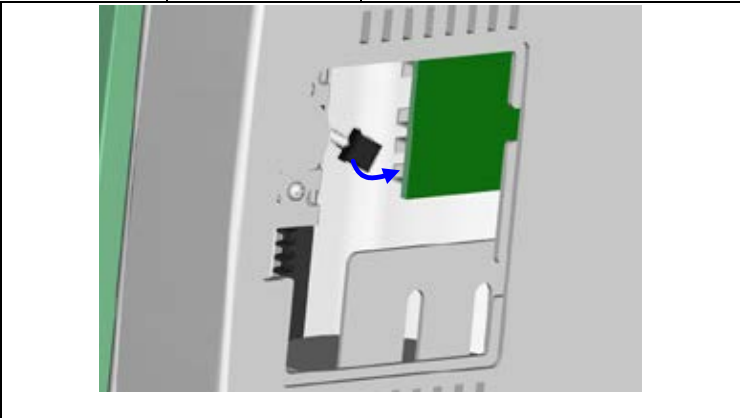
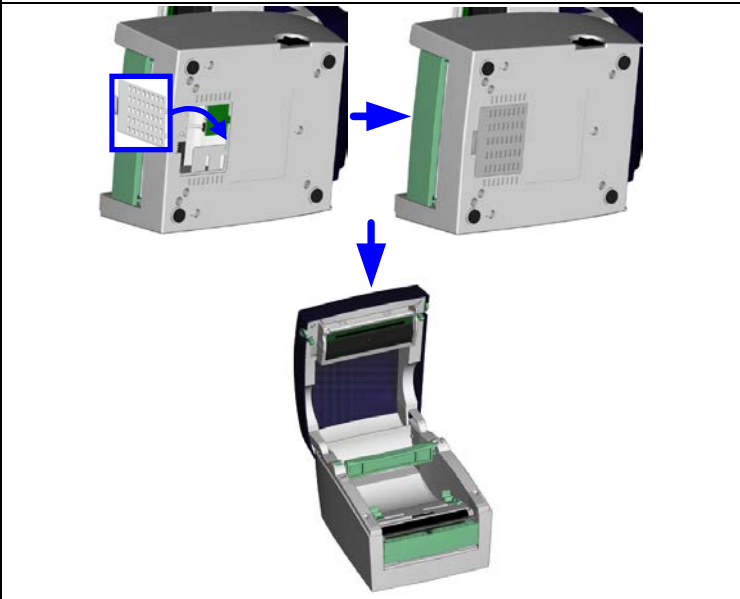
1	Label dispenser	
2	Screws (set of 2)	
<p>【Note 1】 Remember to switch off the printer before installing the label dispenser.</p> <p>【Note 2】 A label liner thickness of $0.006\text{ mm} \pm 10\%$ and a weight of $65\text{ g/m}^2 \pm 6\%$ are recommended.</p> <p>【Note 3】 The label dispenser will take labels up to a max. width of 110 mm (DT4) or 54 mm (DT2).</p>		
1.	Place the printer on a flat surface and open the printer cover.	
<p>2. Remove the front cover.</p> <p>【Note】 You can use a coin or screwdriver to open the cover.</p>		
3.	Pass the dispenser cable through the opening as shown in the illustration.	
4.	Fit the label dispenser in the recess provided.	

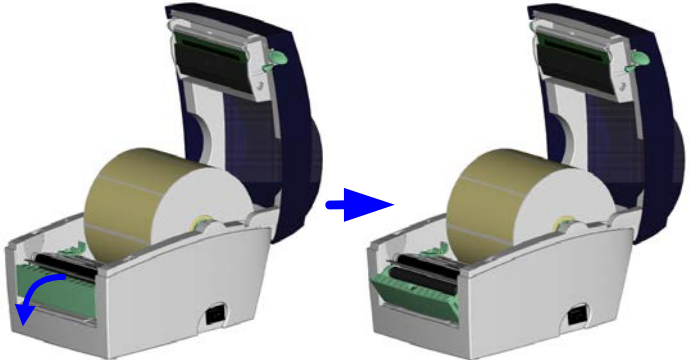
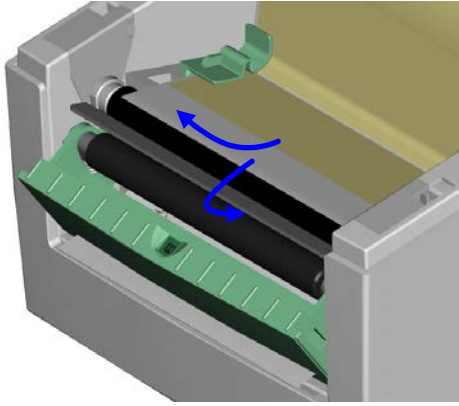
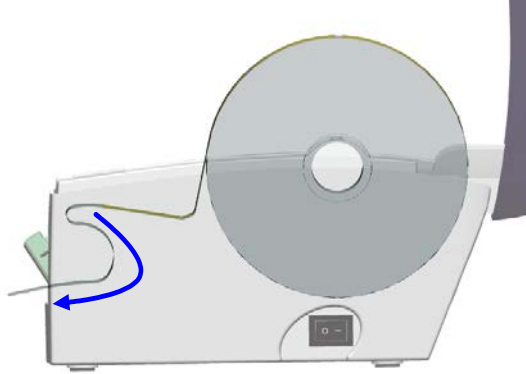
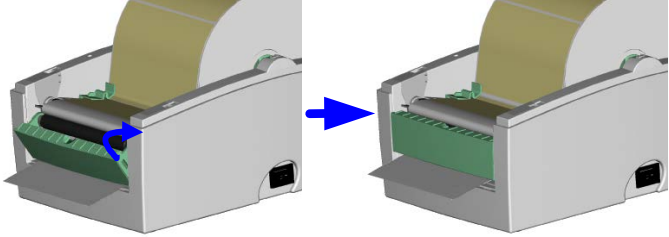
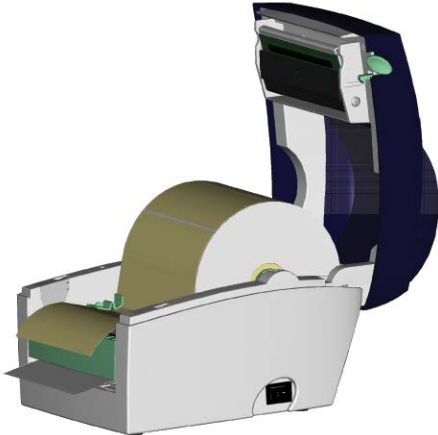
DT4		DT2	
<p>5. Turn the printer upside down and tighten the screws to secure the label dispenser.</p>		<p>5. Turn the printer upside down and remove the screw that secures the cover on the bottom of the printer.</p>	
<p>6. Open the cover on the bottom of the printer to access the motherboard.</p>		<p>6. Tighten the screws to secure the label dispenser.</p>	
<p>【Note】 You can use a coin or screwdriver to open the cover.</p>			
<p>7. Connect the cable to the motherboard.</p> <p>【Note】 The motherboard has two connectors, one for the cutter and the other for the dispenser. Please make sure that you are using the correct connector.</p>			
<p>8. Close the cover again (DT2: and secure it with the screw).</p> <p>9. Place the printer the right way up again.</p>			

<p>10. Open the dispenser by folding it out.</p> <p>11. Load the labels, following the instructions in Section 2-1.</p>	
<p>12. Remove the first label and pass the label liner over the roller and the tear-off plate.</p> <p>【Note】 The label stock should be at least 25 mm high.</p> <p>【Suggestion】 When using the label dispenser, set the stop position to 9 mm (DT2: 8 mm).</p>	
<p>13. Pass the label liner through the printer and dispenser as shown in the illustration.</p>	
<p>14. Fold up the dispenser cover to close it.</p>	
<p>15. Switch on the printer and press the FEED button to measure the label stock.</p>	

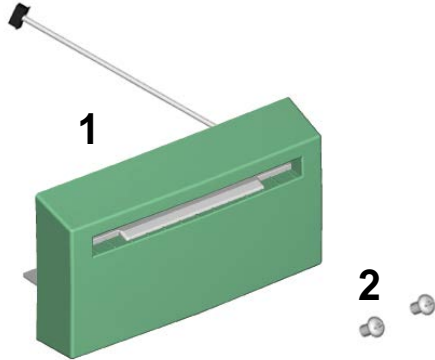
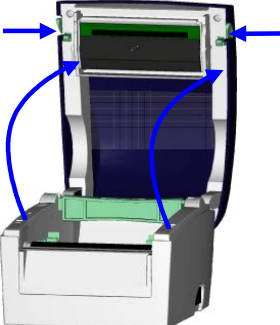
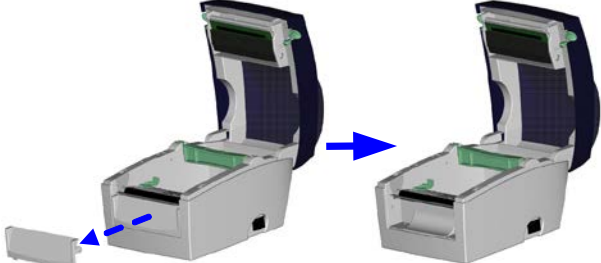
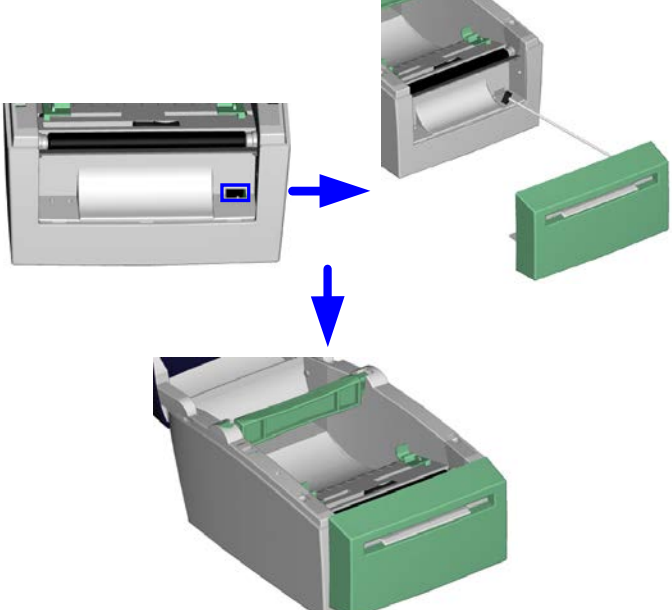
5-2. Installing the cutter

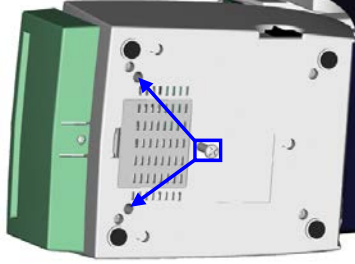
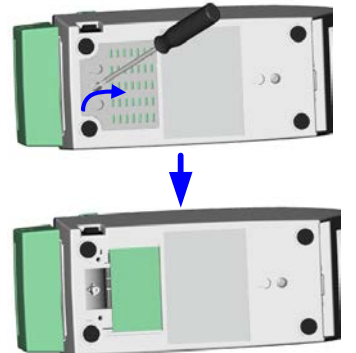
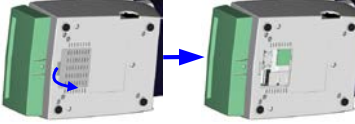
1	Cutter module	
2	Screws (set of 2)	
<p>【Important】 Remember to switch off the printer before installing the cutter.</p> <p>【Note 1】 Do not use to cut adhesive labels! Glue residue will be left on the cutter blade and impair its functioning. The cutter has a blade life of 1,000,000 cuts when using paper weighing up to 120 g/m² and 500,000 cuts when using paper weighing between 120 g and 170 g/m².</p>		<p>【Note 2】 You can cut paper with a max. width of 114 mm.</p> <p>【Note 3】 Labels should be at least 30 mm high (DT4). (DT2: 40 mm)</p> <p>【Suggestion】 During installation of the cutter, set the stop position in Qlabel and/or in the driver to 30.</p>
1.	Place the printer on a flat surface and open the printer cover.	
2.	Remove the front cover.	
3.	Pass the cutter cable through the opening as shown in the illustration.	
4.	Fit the label cutter in the recess provided.	

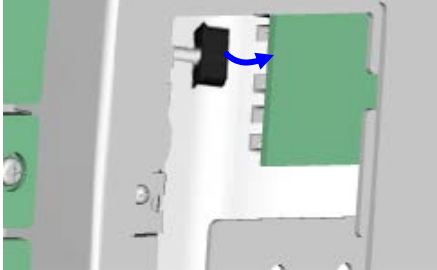
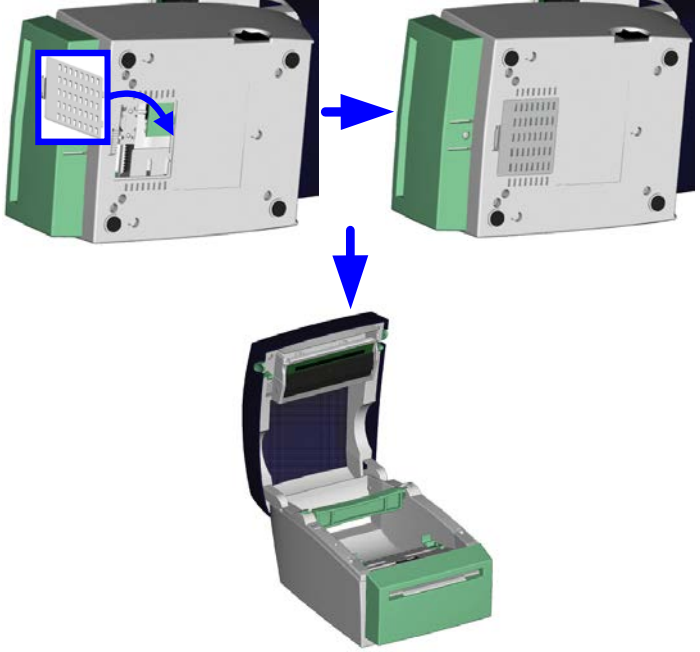
DT4		DT2	
<p>5. Turn the printer upside down and tighten the screws to secure the cutter.</p>		<p>5. Turn the printer upside down and remove the screw that secures the cover on the bottom of the printer.</p>	
<p>6. Open the cover on the bottom of the printer to access the motherboard.</p>		<p>6. Tighten the screws to secure the label cutter.</p>	
<p>7. Connect the cutter to the motherboard.</p> <p><i>【Note】</i> <i>Please make sure that you are using the correct connector.</i></p>			
<p>8. Close the cover on the bottom of the printer (DT2: and secure it with the screw).</p> <p>9. Place the printer the right way up again. In the next step, load the label stock.</p>			

10. Follow the instructions in Section 2-1.

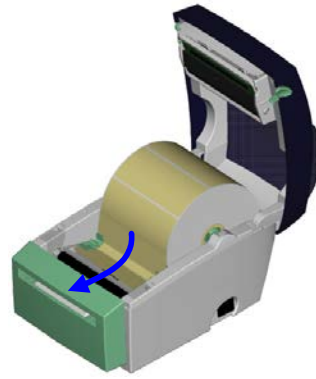

11. Pass the start of the label roll through the cutter and press the FEED button to finish.

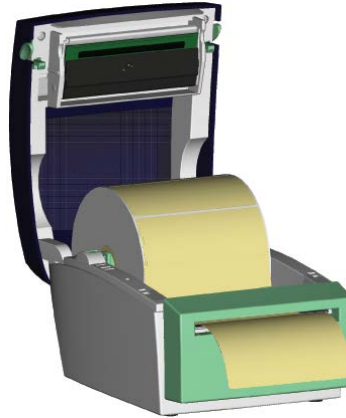

6. Maintenance and adjustment

6-1. Cleaning the print head

Dirt on the print head or ribbon, or glue residue from the label liner may result in inadequate print quality. The printer cover must therefore always be closed. Keeping dirt and dust away from the paper or labels ensures a good print quality and a longer lifespan of the print head. Here is how you clean the print head:

1. Switch off the printer.
2. Open the printer cover.
3. To remove any label residue or other dirt from the print head (see blue arrow), please use a soft lint-free cloth dipped in alcohol.

【Note 1】

The print head should be cleaned once a week.

【Note 2】

Please make sure that there are no metal fragments or other hard particles on the soft cloth used to clean the print head.

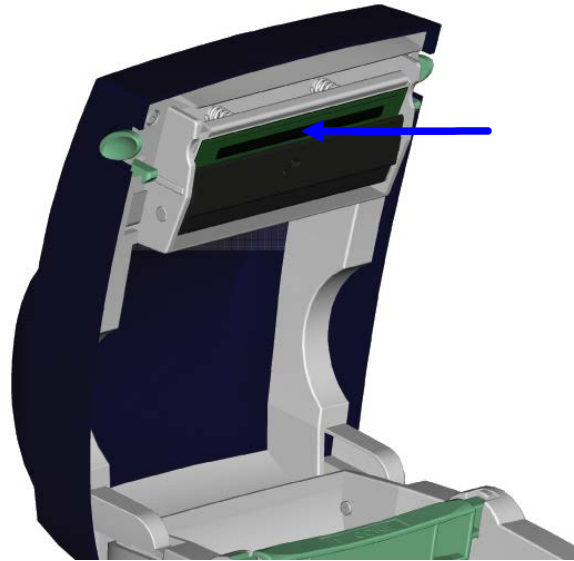

6-2. Adjusting the cutter

While using the cutter, paper jams may occur. You can solve this problem by adjusting the cutter.

1. Turn the printer upside down. A screw is located on the bottom of the cutter housing.
2. Unscrew the screw and remove the housing.

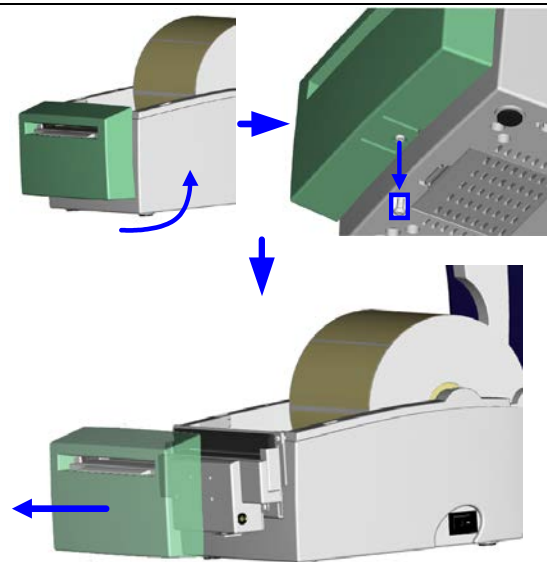

3. The adjustment screw is located on the side of the cutter. Use a screwdriver and turn the screw anticlockwise to loosen the cutter blade and pull out the jammed label.
4. When you have cleared the jam, turn the screw clockwise to secure the cutter blade again.

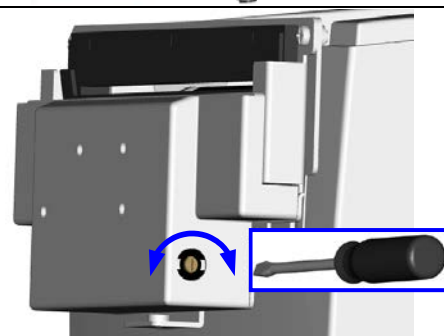

6-3. Labels with black marks

If you are using black-mark label stock that has the printer's maximum feed width, the printer may not recognise the black marks because they are outside the sensor range. When using label stock with black marks, you should therefore observe the following restrictions:

DT2

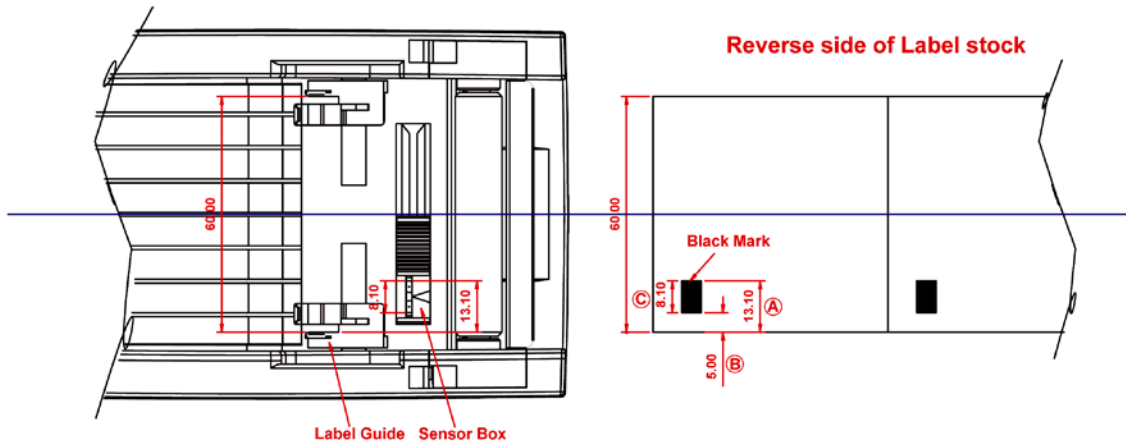

For 60 mm wide label stock, the black marks should have the following positions and sizes:

- A > 13.1 mm high
- B < 5mm high
- C > 8.1 mm high

DT4

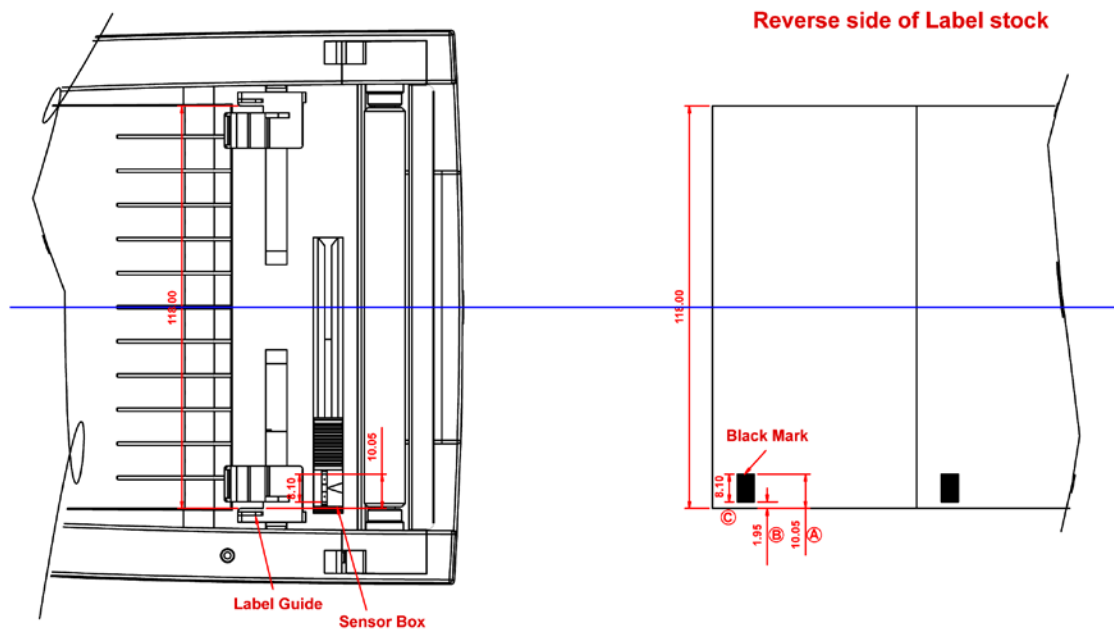

For 118 mm wide label stock, the black marks should have the following positions and sizes:

- A > 10.05 mm high
- B < 1.95 mm high
- C > 8.1 mm high

6-4. Troubleshooting

Problem	Solution
The printer is switched on but the LEDs do not light up.	<ul style="list-style-type: none"> ◆ Check the power supply.
The LED lights up red (ERROR) and printing is interrupted.	<ul style="list-style-type: none"> ◆ Check whether is an error in the software settings or the print commands. ◆ Replace the print medium with a suitable medium. ◆ Check whether there is a label jam. ◆ Check whether the label stock is finished. ◆ Check whether the print mechanism is closed (the print head is not positioned correctly). ◆ Check whether the print medium is covering the sensor. ◆ Check whether the cutter is functioning normally and whether it is cutting at all. (Only if a cutter is installed.)
The label stock passes through the printer but no image is printed.	<ul style="list-style-type: none"> ◆ Please make sure that the label stock is loaded the right way up and that it is suitable material. ◆ Choose the correct printer driver. ◆ Choose the correct label stock and a suitable printing mode.
The label stock jams during printing.	<ul style="list-style-type: none"> ◆ Clear the paper jam. Remove any label material left on the thermal print head and clean the print head using a soft lint-free cloth dipped in alcohol.
The label stock does not move correctly and there is no printed image on some parts of the label.	<ul style="list-style-type: none"> ◆ Check whether any label material is stuck to the thermal print head. ◆ Check for errors in the application software. ◆ Check whether the starting position has been set incorrectly. ◆ Check the power supply.
There is no printed image on part of the label.	<ul style="list-style-type: none"> ◆ Check the thermal print head for dust or other dirt. ◆ Use the internal “~T” command to check whether the thermal print head will carry out a complete print job. ◆ Check the quality of the print medium.
The printed image is positioned incorrectly.	<ul style="list-style-type: none"> ◆ Check whether there is paper or dust covering the sensor. ◆ Check whether the label liner is suitable. Please contact your dealer. ◆ Check the paper guide settings.
A label is missed out during printing.	<ul style="list-style-type: none"> ◆ Check the label height setting. ◆ Check whether there is dust covering the sensor.
The printed image is blurred.	<ul style="list-style-type: none"> ◆ Check the darkness setting. ◆ Check the thermal print head for glue residue or other dirt.
The cutter does not cut off the labels in a straight line.	<ul style="list-style-type: none"> ◆ Check whether the label stock is positioned straight.
The cutter does not cut off the labels completely.	<ul style="list-style-type: none"> ◆ Check whether the label is more than 0.16 mm thick.
When using the cutter, the labels are not fed through or cut off incorrectly.	<ul style="list-style-type: none"> ◆ Check whether the cutter has been correctly installed. ◆ Check whether the paper guides are functioning correctly.
The stripper is not functioning correctly.	<ul style="list-style-type: none"> ◆ Check whether there is dust on the label dispenser. ◆ Check whether the label stock is positioned correctly.

【Note】 If any problems occur that are not described here, please contact your dealer.

Appendix

A. Printer interfaces

Serial port

Default setting : Baud rate 9600, no parity, 8 data bits, 1 stop bit, XON/XOFF protocol and RTS/CTS

RS232 housing (9-pin to 9-pin)

DB9 socket		DB9 plug
---	1	+5V, max 500mA
RXD	2	TXD
TXD	3	RXD
DTR	4	N/C
GND	5	GND
DSR	6	RTS
RTS	7	CTS
CTS	8	RTS
RI	9	N/C
Computer		Printer

[Note] The total current to the serial port may not exceed 500 mA.

USB port

Connector type : Type B

Pin No.	1	2	3	4
Function	VBUS	D-	D+	GND

Internal interface

UART1 wafer		Ethernet module
N.C	1	N.C
TXD	2	RXD
RXD	3	TXD
CTS	4	RTS
GND	5	GND
RTS	6	CTS
E_MD	7	E_MD
RTS	8	CTS
E_RST	9	E_RST
+5V	10	+5V
GND	11	GND
+5V	12	+5V