

TTP-2410M Pro/346M Pro/644M Pro
TTP-246M Pro/344M Pro

**THERMAL TRANSFER / DIRECT THERMAL
BAR CODE PRINTER**

**USER'S
MANUAL**

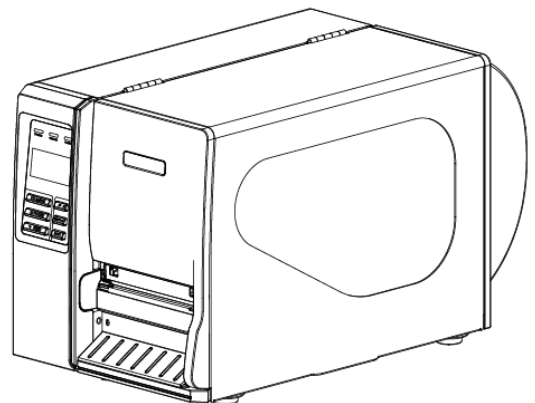

Copyright Information

©2011 TSC Auto ID Technology Co., Ltd,

The copyright in this manual, the software and firmware in the printer described therein are owned by TSC Auto ID Technology Co., Ltd, All rights reserved.

CG Triumvirate is a trademark of Agfa Corporation. CG Triumvirate Bold Condensed font is under license from the Monotype Corporation. Windows is a registered trademark of Microsoft Corporation.

All other trademarks are the property of their respective owners.

Information in this document is subject to change without notice and does not represent a commitment on the part of TSC Auto ID Technology Co. No part of this manual may be reproduced or transmitted in any form or by any means, for any purpose other than the purchaser's personal use, without the expressed written permission of TSC Auto ID Technology Co.

Agency Compliance and Approvals



CE CLASS A
EN 55022:2006 +A1:2007
EN 55024:1998+A1:2001+A2:2003
EN 61000-4 SERIES REGULATIONS



FCC CFR Title 47 Part 15 Subpart B:2010-Section 15.107 and 15.109
ICES-003 Issue 4:2004 Class A

This device complies with Part 15 of the FCC Rules.
Operation is subject to the following two conditions.
(1) This device may not cause harmful interference, and
(2) This device must accept any interference received,
including interference that may cause undesired operation.



AS/NZS CISPR 22:2009
CLASS A



GB-4953-2001
GB9254-2008 (CLASS A)
GB17625.1-2003

此为 A 级产品，在生活环境中，该产品可能会造成无线电干扰，在这种情况下，可能需要用户对干扰采取切实可行的措施。



UL 60950-1(2nd Edition)
CSA C22.2 No. 60950-1-07(2nd Edition)

CAUTION

1. HAZARDOUS MOVING PARTS IN CUTTER MODULE. KEEP FINGER AND OTHER BODY PARTS AWAY.
2. THE MAIN BOARD INCLUDES REAL TIME CLOCK FEATURE HAS LITHIUM BATTERY CR2032 INSTALLED. RISK OF EXPLOSION IF BATTERY IS REPLACED BY AN INCORRECT TYPE.
3. DISPOSE OF USED BATTERIES ACCORDING TO THE MANUFACTURER INSTRUCTIONS.

ATTENTION

1. PIÈCES DANGEREUSES EN MOUVEMENT DANS LE MODULE DE COUPAGE. GARDER VOS DOIGTS ET AUTRES PARTIES DU CORPS À L'ÉCART DE CES ZONES.
2. LE CIRCUIT PRINCIPAL CONTIENT UNE HORLOGE EN TEMPS RÉEL AVEC UNE BATTERIE AU LITHIUM DE TYPE CR2032. RISQUE D'EXPLOSION SI LA PILE EST REMPLACÉE PAR UNE PILE D'UN AUTRE TYPE.
3. SUIVRE LES INSTRUCTIONS DU FABRICANT POUR LA MISE AU REBUT DES PILES USÉES.



EN 60950-1/A1:2010



IEC 60950-1/A1:2009
IEC 60950-1:2005(2nd Edition)

Contents

1. Introduction	1
1.1 Product Introduction	1
1.2 Product Features	2
1.2.1 Printer standard features	2
1.2.2 Printer optional features	4
1.3 General Specification	5
1.4 Print Specifications	6
1.5 Ribbon Specifications	7
1.6 Media Specifications	7
2. Operations Overview	9
2.1 Unpacking and Inspection	9
2.2 Printer Overview	10
2.2.1 Front View	10
2.2.2 Interior view	11
2.2.3 Rear View	12
2.3 Operator Controls	14
2.3.1 Front Panel Display	14
2.3.2 LED Indicators	14
2.3.3 Front Panel Keys	15
2.4 Setting up the Printer	15
2.5 Loading Ribbon	16
2.5.1 Loading Ribbon	16
2.5.2 Remove Used Ribbon	19
2.6 Loading the Media	20
2.6.1 Loading the Media	20
2.6.2 Loading Fan-fold Labels	24
2.6.3 Loading Media in Peel-off Mode (Option)	26
2.6.4 Remove Liner from Internal Rewind (Option)	28
2.6.5 Loading Media in Rewind Liner with Label Mode (Option)	29
2.6.6 Remove Labels from Internal Rewind (Option)	31
2.7 Adjustment Knob	32
2.7.1 Print head Pressure Adjustment Knob	32
2.7.2 Print Head Burn Line Adjustment Knob	32
2.8 Using the Keyboard with PS/2 Interface (Optional for TTP-246M Pro/TTP-344M Pro models)	34

3. Menu Function	35
3.1 Setup Menu Overview	36
3.1.1-1 Printer Setup (TSPL2)	37
3.1.1-2 Printer Setup (ZPL2)	44
3.1.2 Sensor	51
3.1.3 Serial Comm.	59
3.1.4 Ethernet	62
3.2 File Manager	65
3.2.1 File List	65
3.2.2 Avail. Memory	65
3.2.3 Del. All Files	66
3.3 Diagnostics	67
3.3.1 Print Config.	67
3.3.2 Dump Mode	70
3.3.3 Rotate Cutter	71
3.4 Language	71
3.5 Service	72
3.5.1 Initialization	72
3.5.2 Mileage Info.	73
4. Diagnostic Tool	74
4.1 Start the Diagnostic Tool	74
4.2 Printer Function (Calibrate sensor, Ethernet setup, RTC setup.....)	75
5 Setting Ethernet by Diagnostic Utility (Optional for TTP-246M Pro/TTP-344M Pro models)	76
5.1 Using USB interface to setup Ethernet interface	76
5.2 Using RS-232 interface to setup Ethernet interface	77
5.3 Using Ethernet interface to setup Ethernet interface	78
6. Troubleshooting	80
6.1 Common Problems	80
6.2 Mechanism Fine Adjustment to Avoid Ribbon Wrinkles	84
7. Maintenance	86
Revise History	88

1. Introduction

1.1 Product Introduction

Thank you very much for purchasing TSC bar code printer.

This printer is designed with die-casting aluminum chassis and print mechanism, metal cover with large clear media view window, which ensuring to work for the extreme and heavy duty industrial environment and applications.

With back-lit graphic LCD display, printer status can be managed easier and operated more user friendly. The moveable sensor design can accept wide range of label media. All of the most frequently used bar code formats are included. Fonts and bar codes can be printed in any one of the four directions.

This printer is built-in the high quality, high performance MONOTYPE IMAGING® True Type font engine and one CG Triumvirate Bold Condensed smooth font. With flexible firmware design, user can also download the True Type Font from PC into printer memory for printing labels. Besides the scalable font, it also provides a choice of five different sizes of alphanumeric bitmap font, OCR-A and OCR-B fonts. By integrating rich features, it is the most cost-effective and high performance printer in its class!

- Applications
 - Industrial-duty printing
 - Healthcare patient safety
 - Compliance labeling
 - Work in process
 - Order fulfillment
 - Distribution
 - Shipping/ receiving
 - Ticketing
 - Electronics & jewelry labeling

1.2 Product Features

1.2.1 Printer standard features

The printer offers the following standard features.

Product standard feature	203 dpi models	300 dpi models	600 dpi models
Thermal transfer printing	<input type="radio"/>	<input type="radio"/>	<input type="radio"/>
Direct thermal printing	<input type="radio"/>	<input type="radio"/>	<input type="radio"/>
High quality die-cast aluminum design	<input type="radio"/>	<input type="radio"/>	<input type="radio"/>
Metal cover with large clear media view window	<input type="radio"/>	<input type="radio"/>	<input type="radio"/>
Moveable gap sensor (position full web adjustable)	<input type="radio"/>	<input type="radio"/>	<input type="radio"/>
Moveable black mark sensor (position full web adjustable)	<input type="radio"/>	<input type="radio"/>	<input type="radio"/>
Ribbon end sensor	<input type="radio"/>	<input type="radio"/>	<input type="radio"/>
Head open sensor	<input type="radio"/>	<input type="radio"/>	<input type="radio"/>
LCD display (graphic type, 128x64 pixel) with back light	<input type="radio"/>	<input type="radio"/>	<input type="radio"/>
Control panel with 6 operation buttons	<input type="radio"/>	<input type="radio"/>	<input type="radio"/>
Control panel security (TCF)	<input type="radio"/>	<input type="radio"/>	<input type="radio"/>
LED indicators	<input type="radio"/>	<input type="radio"/>	<input type="radio"/>
Real time clock	<input type="radio"/>	<input type="radio"/>	<input type="radio"/>
Internal Ethernet print server (10/100 Mbps) interface	<input type="radio"/>	<input type="radio"/>	<input type="radio"/>
USB 2.0 (full speed) interface	<input type="radio"/>	<input type="radio"/>	<input type="radio"/>
Serial RS-232C (2400-115200 bps) interface	<input type="radio"/>	<input type="radio"/>	<input type="radio"/>
Centronics (SPP mode) interface	<input type="radio"/>	<input type="radio"/>	<input type="radio"/>
PS/2 keyboard interface for stand-alone or data entry at print site	<input type="radio"/>	<input type="radio"/>	<input type="radio"/>
32 MB SDRAM memory for *industrial model (8 MB SDRAM memory for *economic model)	<input type="radio"/>	<input type="radio"/>	<input type="radio"/>
8 MB FLASH memory for *industrial model (4 MB FLASH memory for *economic model)	<input type="radio"/>	<input type="radio"/>	<input type="radio"/>
SD FLASH card memory expands storage to 4 GB for *industrial model	<input type="radio"/>	<input type="radio"/>	<input type="radio"/>
Powerful 32 bit 200 MHz RISC processor	<input type="radio"/>	<input type="radio"/>	<input type="radio"/>
Standard industry emulations right out of the box including Eltron® and Zebra® language support	<input type="radio"/>	<input type="radio"/>	<input type="radio"/>

Internal 8 alpha-numeric bitmap fonts	<input type="radio"/>	<input type="radio"/>	<input type="radio"/>									
Fonts and bar codes can be printed in any one of the four directions (0, 90,180, 270 degree)	<input type="radio"/>	<input type="radio"/>	<input type="radio"/>									
Internal Monotype Imaging® true type font engine with one CG Triumvirate Bold Condensed scalable font	<input type="radio"/>	<input type="radio"/>	<input type="radio"/>									
Downloadable fonts from PC to printer memory	<input type="radio"/>	<input type="radio"/>	<input type="radio"/>									
Text, bar code, graphics/image printing (Please refer to the TSPL/TSPL2 programming manual for supporting code page)	<input type="radio"/>	<input type="radio"/>	<input type="radio"/>									
<table border="1"> <thead> <tr> <th colspan="2">Support Bar Code</th> <th>Support image</th> </tr> <tr> <th>1D bar code</th> <th>2D bar code</th> <th></th> </tr> </thead> <tbody> <tr> <td>Code 39, Code 93, Code128UCC, Code128 subsets A.B.C, Codabar, Interleave 2 of 5, EAN-8, EAN-13, EAN-128, UPC-A, UPC-E, EAN and UPC 2(5) digits add-on, MSI, PLESSEY, POSTNET, China POST, RSS-14, Code 11</td> <td>PDF-417, Maxicode, DataMatrix, QR code, Aztec</td> <td>BITMAP, BMP, PCX</td> </tr> </tbody> </table>	Support Bar Code		Support image	1D bar code	2D bar code		Code 39, Code 93, Code128UCC, Code128 subsets A.B.C, Codabar, Interleave 2 of 5, EAN-8, EAN-13, EAN-128, UPC-A, UPC-E, EAN and UPC 2(5) digits add-on, MSI, PLESSEY, POSTNET, China POST, RSS-14, Code 11	PDF-417, Maxicode, DataMatrix, QR code, Aztec	BITMAP, BMP, PCX	<input type="radio"/>	<input type="radio"/>	<input type="radio"/>
Support Bar Code		Support image										
1D bar code	2D bar code											
Code 39, Code 93, Code128UCC, Code128 subsets A.B.C, Codabar, Interleave 2 of 5, EAN-8, EAN-13, EAN-128, UPC-A, UPC-E, EAN and UPC 2(5) digits add-on, MSI, PLESSEY, POSTNET, China POST, RSS-14, Code 11	PDF-417, Maxicode, DataMatrix, QR code, Aztec	BITMAP, BMP, PCX										

* Industrial model: TTP-2410M Pro/TTP-346M Pro/TTP-644M Pro

* Economic model: TTP-246M Pro/TTP-344M Pro

1.2.2 Printer optional features

1.2.2-1 Industrial model

The printer offers the following optional features.

Product option feature	User options	Dealer options	Factory options
Applicator I/O interface	-	-	○
USB Host	-	-	○
Peel-off kit (Include liner rewind spindle and peel off sensor)	-	○	-
Internal rewind kit (Max. 6" OD/ Include label rewind spindle and label redirect kit)	-	○	-
Regular guillotine cutter (Paper thickness: 0.06~ 0.25mm)	○	-	-
Heavy duty cutter module (Paper thickness: Max 0.25 mm/ Max. paper weight <300g/ m ²)	○	-	-
Care label cutter (Paper thickness: Max. 0.15mm)	○	-	-
KP-200 Plus keyboard display unit	○	-	-
KU-007 Plus programmable smart keyboard display unit	○	-	-

Note: Except for the linerless cutter, all regular/heavy duty/care label cutters DO NOT cut on media with glue.

1.2.2-2 Economy model

The printer offers the following optional features.

Product option feature	User options	Dealer options	Factory options
USB Host	-	○	-
Peel-off kit (include liner rewind spindle and peel off sensor)	-	○	-
Internal rewind kit (include label rewind spindle and label redirect kit)	-	○	-
Applicator I/O interface	-	○	-

Internal Ethernet print server	-	○	-
PS/2 keyboard interface	-	○	-
SD FLASH memory card slot	-	○	-
Regular guillotine cutter (Paper thickness: 0.06~ 0.25mm)	○	-	-
Heavy duty cutter module (Paper thickness: Max 0.25 mm/ Max. paper weight <300g/ m ²)	○	-	-
Care label cutter (Paper thickness: Max. 0.15mm)	○	-	-
KP-200 Plus keyboard display unit	○	-	-
KU-007 Plus programmable smart keyboard display unit	○	-	-
HCS-200 long rang CCD scanner	○	-	-

Note: Except for the linerless cutter, all regular/heavy duty/care label cutters DO NOT cut on media with glue.

1.3 General Specification

General Specifications	
Physical dimensions	270 mm (W) x 308 mm (H) x 505 mm (D)
Weight	15 kg (33.1 lb)
Electrical	Internal switching power supply <u>For *industrial model:</u> Input: AC 100-240V, 2A, 50-60Hz Output: DC 24V, 5A, 120W <u>For *economic model</u> Input: AC 100-240V, 3A, 50-60Hz Output: DC 24V, 3.3A, 80W
Environmental condition	Operation: 5 ~ 40°C (41 ~ 104°F), 25~85% non-condensing Storage: -40 ~ 60 °C (-40 ~ 140°F), 5~90% non-condensing

* Industrial model: TTP-2410M Pro/ TTP-346M Pro/ TTP-644M Pro

* Economic model: TTP-246M Pro/ TTP-344M Pro

1.4 Print Specifications

1.4-1 Industrial model

Print Specifications	203 dpi models	300 dpi models	600 dpi models
Print head resolution	203 dots/inch (8 dots/mm)	300 dots/inch (12 dots/mm)	600 dots/inch (24 dots/mm)
Printing method	Thermal transfer and direct thermal		
Dot size (width x length)	0.125 x 0.125 mm (1 mm = 8 dots)	0.084 x 0.084 mm (1 mm = 12 dots)	0.042 x 0.042 mm (1 mm = 24 dots)
Print speed (inches per second)	2, 3, 4, 5, 6, 7, 8, 10, 11, 12 ips selectable Up to 12 ips	2, 3, 4, 5, 6, 7, 8 ips selectable Up to 8 ips	2, 3, 4 ips selectable Up to 4 ips
Max. print width	104 mm (4.09")		
Max. print length	4064 mm (160")	1854.2 mm (73")	1016 mm (40")
Printout bias	Vertical: 1 mm max. Horizontal: 1 mm max.		

1.4-2 Economy model

Print Specifications	203 dpi models	300 dpi models
Print head resolution	203 dots/inch (8 dots/mm)	300 dots/inch (12 dots/mm)
Printing method	Thermal transfer and direct thermal	
Dot size (width x length)	0.125 x 0.125 mm (1 mm = 8 dots)	0.084 x 0.084 mm (1 mm = 12 dots)
Print speed (inches per second)	2, 3, 4, 5, 6, 7, 8 ips selectable Up to 8 ips	2, 3, 4, 5, 6 ips selectable Up to 6 ips
Max. print width	108 mm (4.25")	104 mm (4.09")
Max. print length	2286 mm (90")	1016 mm (40")
Printout bias	Vertical: 1 mm max. Horizontal: 1 mm max.	

1.5 Ribbon Specifications

Ribbon Specifications	
Ribbon outside diameter	90 mm
Ribbon length	600 meter
Ribbon core inside diameter	1 inch (25.4 mm)
Ribbon width	Max. 114.3 mm (4.5")
	Min. 25.4 mm (1.0")
Ribbon wound type	Ink coated outside wound, ink coated inside wound
Ribbon end type	Transparency

1.6 Media Specifications

1.6-1 Industrial model

Media Specifications	203 dpi models	300 dpi models	600 dpi models
Label roll capacity	208.3 mm (8.2")		
Media alignment	Edge alignment		
Media type	Continuous, die-cut, black mark, fan-fold, notch		
Media wound type	Printing face outside wound		
Media width (label + liner)	Max. 118 mm (4.6")		
	Min. 25.4 mm (1.0")		
Media thickness (label + liner)	Max. 0.30 mm (11.8 mil)		
	Min. 0.06 mm (2.36 mil)		
Media core diameter	Max. 76.2 mm (3")		
	Min. 25.4 mm (1")		
Label length	Max. 4,064 mm (160")	Max. 1,854 mm (73")	Max. 1016 mm (40")
	Min. 5 mm (0.20")	Min. 5 mm (0.20")	Min. 5 mm (0.20")
Label length (peeler mode)	Max. 152.4 mm (6")		
	Min. 25.4 mm (1")		
Label length (cutter mode)	Max. 4,064 mm (160")	Max. 1,854 mm (73")	Max. 1016 mm (40")
	Min. 25.4 mm (1")	Min. 25.4 mm (1")	Min. 25.4 mm (1")
Gap height	Min. 2 mm		
Black mark height	Min. 2 mm		
Black mark width	Min. 8 mm (0.31")		

1.6-2 Economy model

Media Specifications	203 dpi models	300 dpi models
Label roll capacity	208.3 mm (8.2")	
Media alignment	Edge alignment	
Media type	Continuous, die-cut, black mark, fan-fold, notch	
Media wound type	Printing face outside wound	
Media width (label + liner)	Max. 118 mm (4.6")	
	Min. 25.4 mm (1.0")	
Media thickness (label + liner)	Max. 0.30 mm (11.8 mil)	
	Min. 0.06 mm (2.36 mil)	
Media core diameter	Max. 76.2 mm (3")	
	Min. 25.4 mm (1")	
Label length	Max 2,286 mm (90")	Max. 1,016 mm (40")
	Min. 5 mm (0.20")	Min. 5 mm (0.20")
Label length (peeler mode)	Max. 152.4 mm (6")	
	Min. 25.4 mm (1")	
Label length (cutter mode)	Max. 2,286 mm (90")	Max.1,016 mm (40")
	Min. 25.4 mm (1")	Min. 25.4 mm (1")
Gap height	Min. 2 mm	
Black mark height	Min. 2 mm	
Black mark width	Min. 8 mm (0.31")	

2. Operations Overview

2.1 Unpacking and Inspection

This printer has been specially packaged to withstand damage during shipping. Please carefully inspect the packaging and printer upon receiving the bar code printer. Please retain the packaging materials in case you need to reship the printer.

Unpacking the printer, the following items are included in the carton.

- One printer unit
- One Windows labeling software/Windows driver CD disk
- One quick installation guide
- One power cord
- One USB interface cable

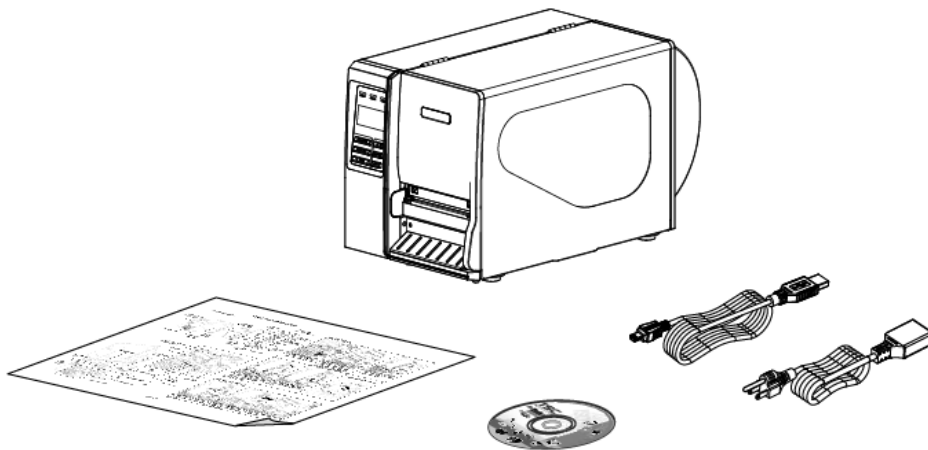

If any parts are missing, please contact the Customer Service Department of your purchased reseller or distributor.

2.2 Printer Overview

2.2.1 Front View



1. LED indicators
2. LCD display
3. Front panel buttons
4. Paper exit chute
5. Lower front cover
6. Printer right side cover

2.2.2 Interior view

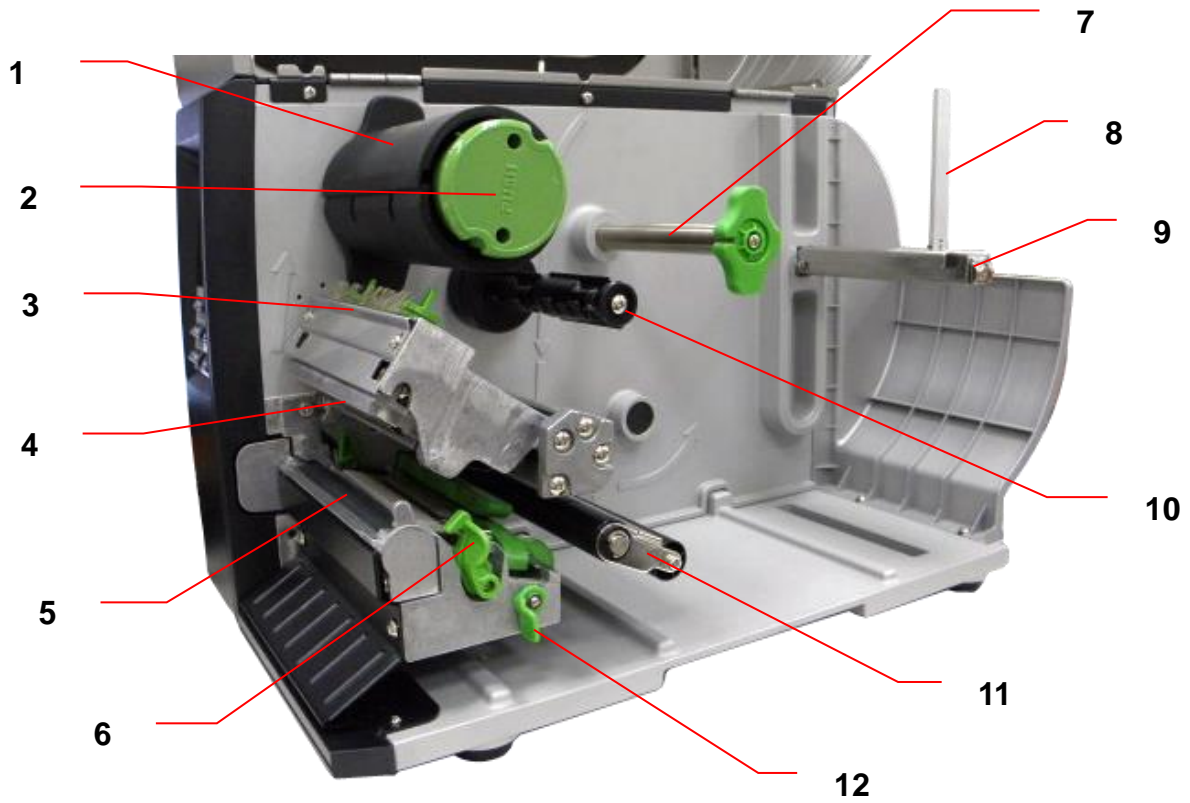

1. Ribbon rewind spindle
2. Ribbon release button
3. Ribbon guide plate
4. Print head
5. Platen roller
6. Print head release lever
7. Media guide bar
8. Label roll guard
9. Label supply spindle
10. Ribbon supply spindle
11. Damper
12. Media sensor lock lever
13. Z axis mechanism adjustment knob
14. Print head pressure adjustment knob
15. Anti-static brush
16. Ribbon sensor
17. Media sensor
18. Label guide

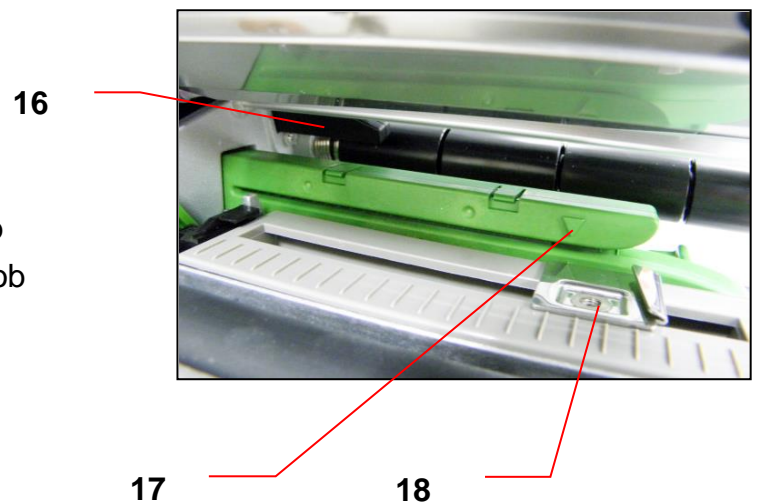
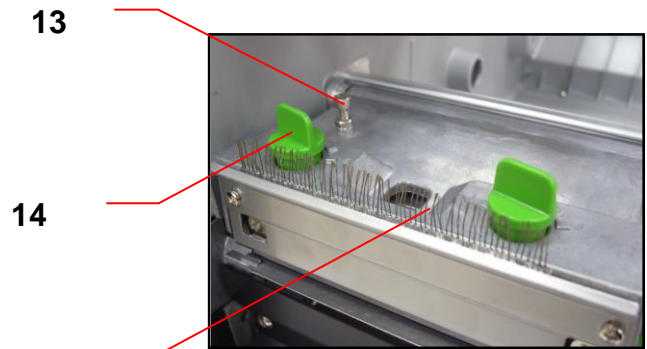

2.2.3 Rear View



1. Fan-fold paper entrance chute
2. Centronics interface
3. USB interface
4. RS-232C interface
5. Power jack socket
6. GPIO interface (Option)
- *7. SD card slot
8. Ethernet interface
9. USB host (Option)
10. PS/2 interface
11. Power switch

Note:

1. SD card slot, Ethernet interface and PS/2 interface are standard interfaces for TTP-2410M Pro/TTP-346M Pro/TTP-644M Pro models (*Industrial model), but optional for TTP-246M Pro/TTP-344M Pro models (*Economy model).
2. GPIO interface card includes SD card slot, Ethernet and PS/2 interfaces. So GPIO interface is an factory option for TTP-2410M Pro/TTP-346M Pro/TTP-644M Pro, but a dealer option for TTP-246M Pro/TTP-344M Pro models.

* Industrial model: TTP-2410M Pro/ TTP-346M Pro/ TTP-644M Pro

* Economic model: TTP-246M Pro/ TTP-344M Pro

Note:

The interface picture here is for reference only. Please refer to the product specification for the interfaces availability.

*** Recommended SD card specification.**

SD card spec	SD card capacity	Approved SD card manufacturer
V1.0, V1.1	128 MB	SanDisk, Transcend
V1.0, V1.1	256 MB	SanDisk, Transcend, Panasonic
V1.0, V1.1	512 MB	SanDisk, Transcend, Panasonic
V1.0, V1.1	1 GB	SanDisk, Transcend, Panasonic
V2.0 SDHC CLASS 4	4 GB	
V2.0 SDHC CLASS 6	4 GB	SanDisk, Transcend, Panasonic
V1.0, V1.1	microSD 128 MB	Transcend, Panasonic
V1.0, V1.1	microSD 256 MB	Transcend, Panasonic
V1.0, V1.1	microSD 512 MB	Panasonic
V1.0, V1.1	microSD 1 GB	Transcend, Panasonic
V2.0 SDHC CLASS 4	microSD 4 GB	Panasonic
V2.0 SDHC CLASS 6	microSD 4 GB	Transcend
V1.0, V1.1	miniSD 128 MB	Transcend, Panasonic
V1.0, V1.1	miniSD 256 MB	Transcend, Panasonic
V1.0, V1.1	miniSD 512 MB	Transcend, Panasonic
V1.0, V1.1	miniSD 1 GB	Transcend, Panasonic
V2.0 SDHC CLASS 4	miniSD 4 GB	Transcend
V2.0 SDHC CLASS 6	miniSD 4 GB	
<ul style="list-style-type: none"> - The DOS FAT file system is supported for the SD card. - Folders/files stored in the SD card should be in the 8.3 filename format - The miniSD/microSD card to SD card slot adapter is required. 		

2.3 Operator Controls



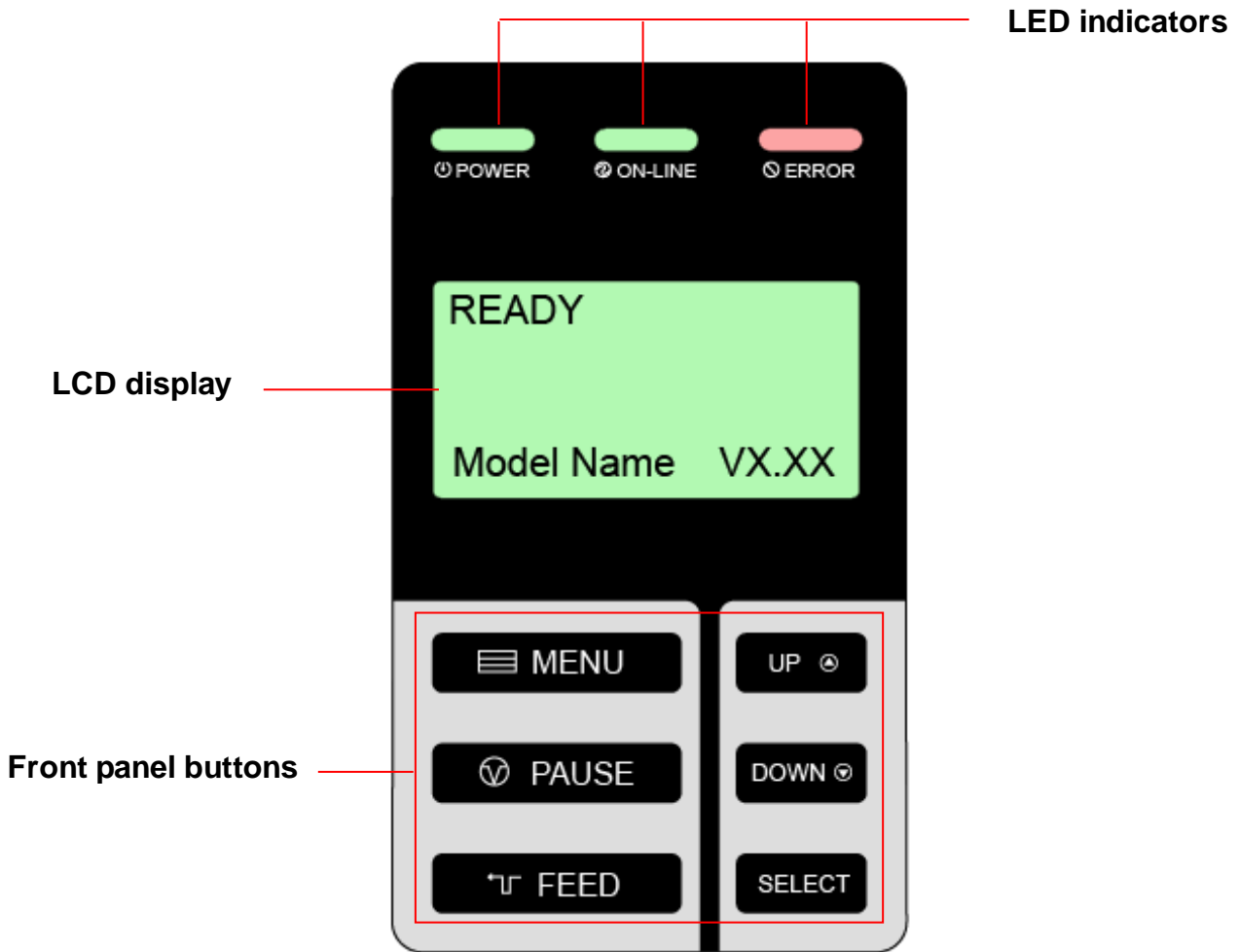



2.3.1 Front Panel Display



2.3.2 LED Indicators

LED	Status	Indication
⏻ POWER	Off	The printer power is turned off
	On	The printer power is turned on
🔄 ON-LINE	On	Printer is ready
	Blinking	Pause Downloading data into printer.
🚫 ERROR	Off	Printer is ready
	On	“CARRIAGE OPEN” or “CUTTER ERROR”
	Blinking	“NO PAPER”, “PAPER JAM”, “NO RIBBON” or “CLEAN DATA”

2.3.3 Front Panel Keys

Keys	Function
 MENU	1. Enter the menu 2. Exit from a menu or cancel a setting and return to the previous menu
 PAUSE	Pause/Resume the printing process
 FEED	Advance one label
 UP	Scroll up the menu list
 DOWN	Scroll down the menu list
 SELECT	Enter/Select cursor located option

2.4 Setting up the Printer

1. Place the printer on a flat, secure surface.
2. Make sure the power switch is off.
3. Connect the printer to the computer with the provided USB cable.
4. Plug the power cord into the AC power cord socket at the rear of the printer, and then plug the power cord into a properly grounded power outlet.

Note:

Please switch OFF printer power switch prior to plug in the power cord to printer power jack.

2.5 Loading Ribbon

2.5.1 Loading Ribbon

	<p>1. Open the printer right side cover.</p>
	<p>2. Push the print head release lever to open the print head mechanism.</p>
	<p>3. Install the ribbon onto the ribbon supply spindle.</p>

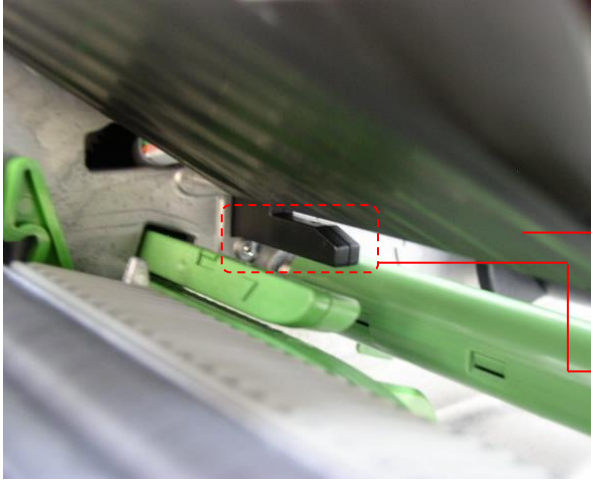

4. Thread the ribbon through the ribbon sensor slot and then through the open space in between print head and platen.

Ribbon

Ribbon sensor

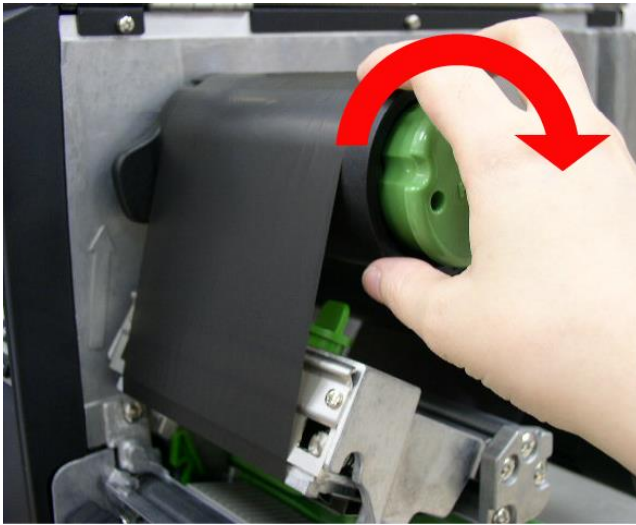

5. Wrap the ribbon onto the ribbon rewind spindle. Wind the ribbon clockwise about 3~5 circles onto the ribbon rewind spindle until it is smooth and properly stretched.

Note: Please **DO NOT** push the ribbon release button when you are loading the ribbon. The ribbon release button is used to remove the used ribbon. ([Please refer to section 2.5.2](#))

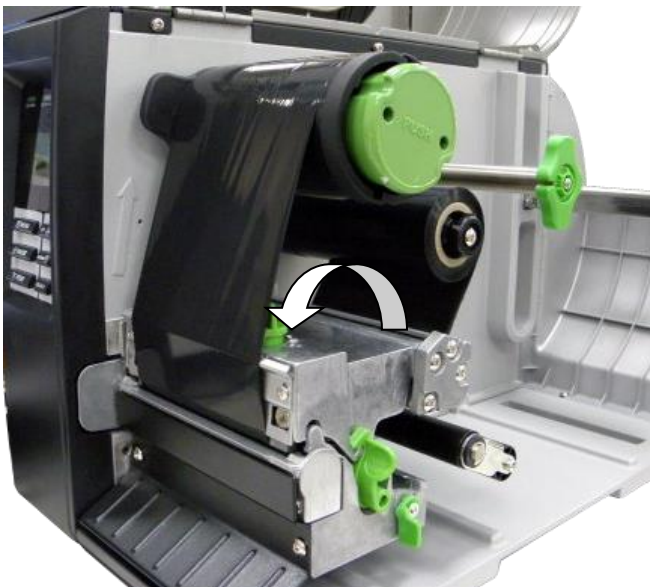

6. Close the print head mechanism, Make sure the latches are engaged securely.

Note:

Please refer to videos on [TSC YouTube](#) or driver CD.

- **Loading path for ribbon**

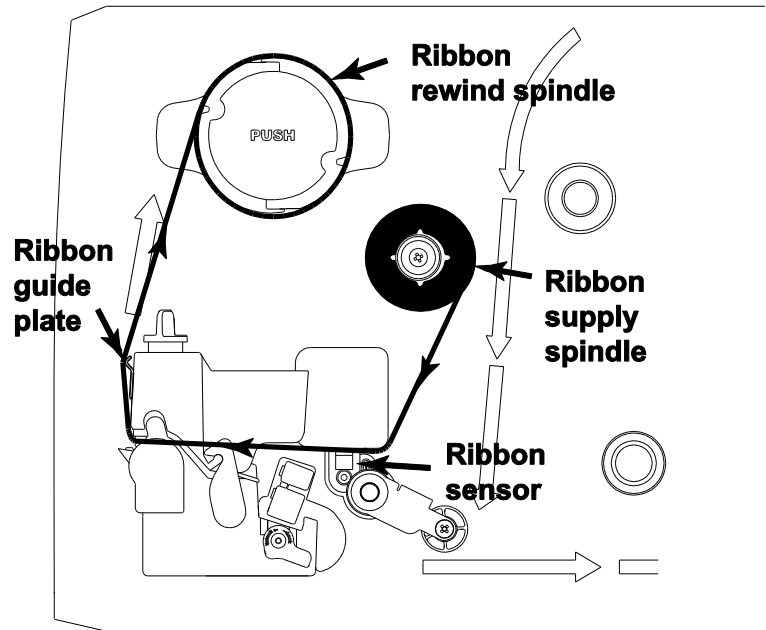

2.5.2 Remove Used Ribbon

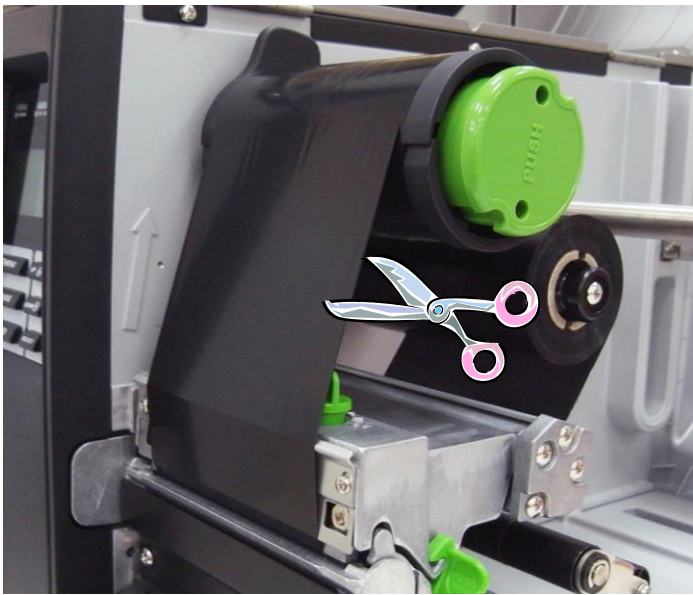

1. Break the ribbon between ribbon guide plate and the ribbon rewind spindle.



2. Push the ribbon release button to release the ribbon on the ribbon rewind spindle.



3. Then, slide off the ribbon from ribbon rewind spindle.

2.6 Loading the Media

2.6.1 Loading the Media

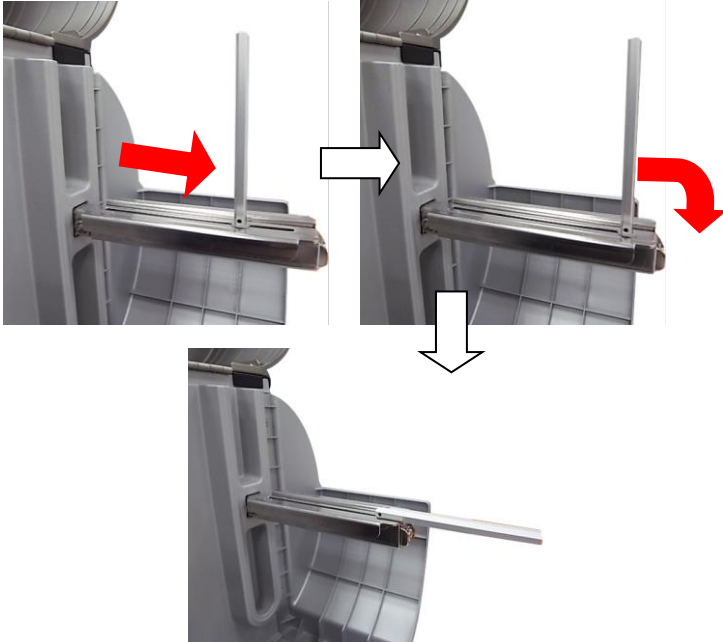
	<p>1. Open the printer right side cover.</p>
	<p>2. Push the print head release lever to open the print head mechanism.</p>
	<p>3. Move the label roll guard horizontally to the end of label spindle then flip down the label roll guard.</p>

4. Place the roll of media on the label supply spindle. Flip up the label roll guard. Move the label roll guard horizontally to gently fit the width of label roll.

3" Label spindle



1" Label spindle

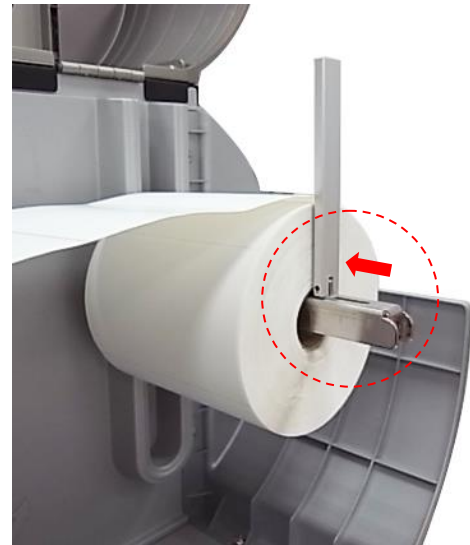

Note: Replace 3" label supply spindle to fit the 1" core label by removing two screws.

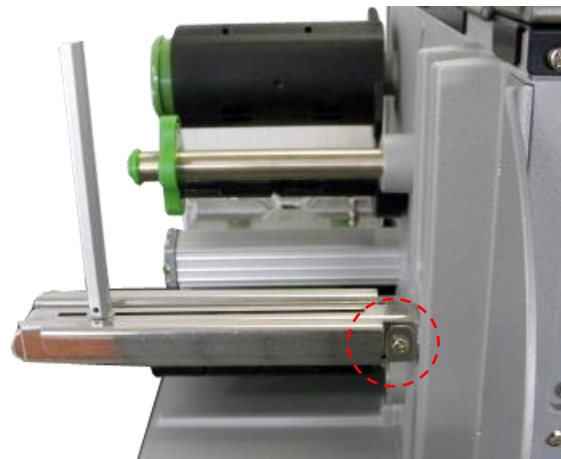

5. Pull label roll leading edge forward through the media guide bar, damper, media sensor and place the label leading edge onto the platen roller.

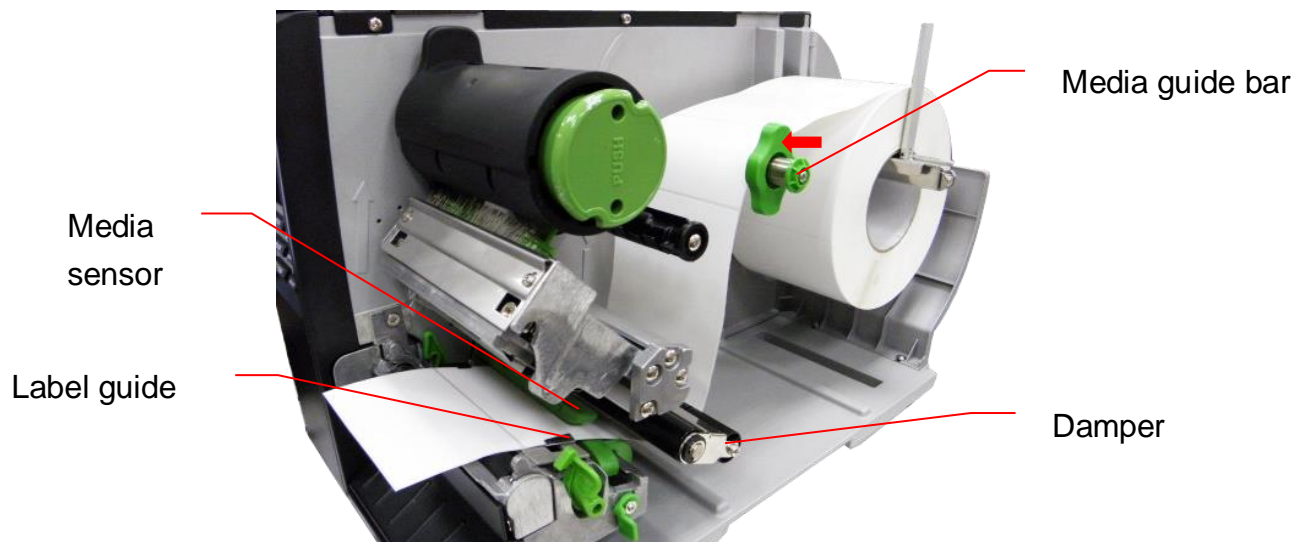

6. Unlock the media sensor lock lever to adjust the media sensor.

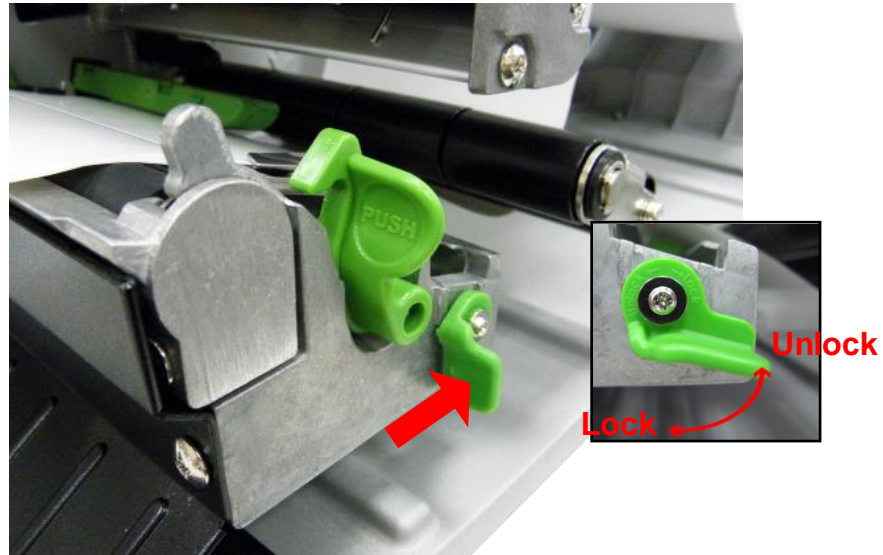

Gap label



Black mark label



- * The sensor location is marked by a triangle mark ∇ at the sensor housing.
- * The media sensor position is moveable, please make sure the gap or black mark is at the location where media gap/black mark will pass through for sensing.

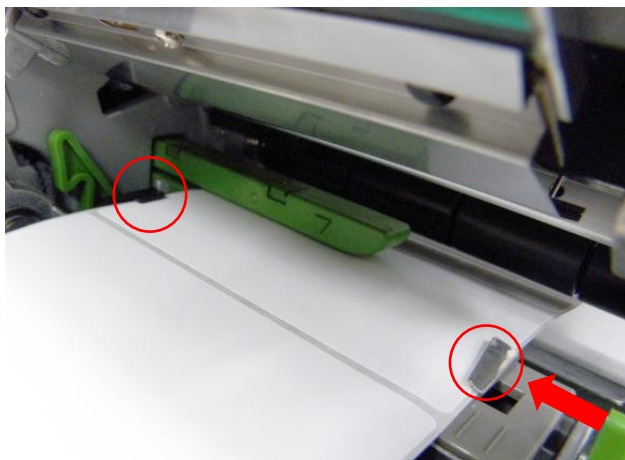

7. Adjust the label guide to fit the width of the label.

8. Close the print head mechanism. Make sure the latches are engaged securely.

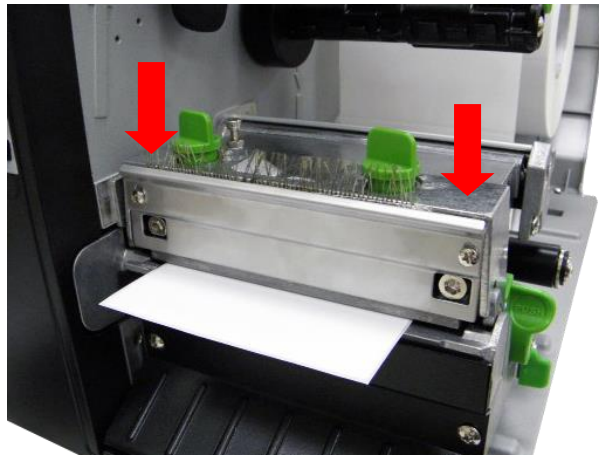

9. Using the front display panel, set the media sensor type and calibrate the selected sensor. (Please refer to section 3.1.2)

Note:

- * Please calibrate the gap/black mark sensor when changing media.
- * Please refer to videos on [TSC YouTube](#) or driver CD.

● Loading path for roll labels

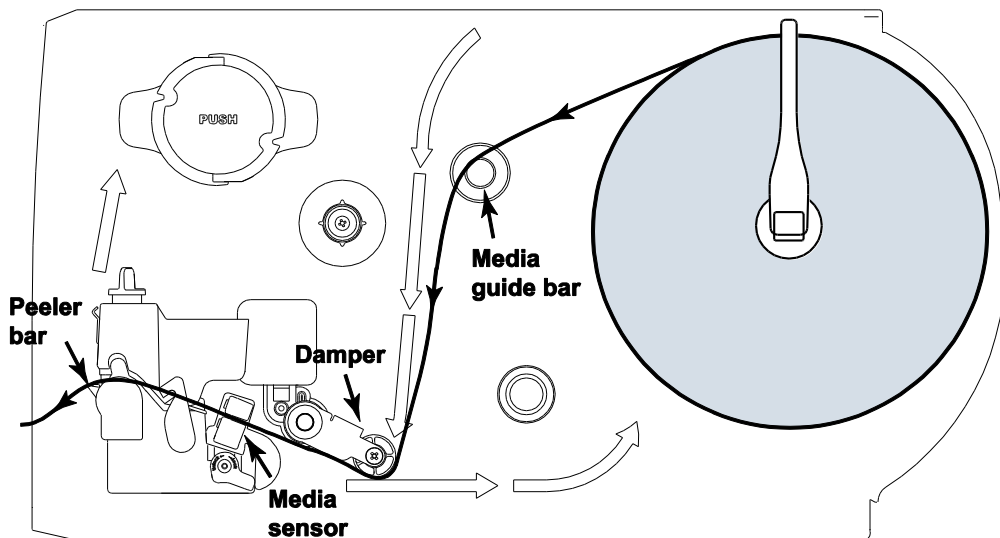

2.6.2 Loading Fan-fold Labels

Fan-fold media feeds through either the bottom or rear external label entrance chute.

1. Open the printer right side cover.
2. Push the print head release lever to open the print head mechanism.



3. Insert the fan-fold media through the bottom or rear external label entrance chute.
4. Pull fan-fold label leading edge forward through the media guide bar, damper media sensor and place the label leading edge onto the platen roller.
5. Adjust the label guide by sliding to fit the paper width.
6. Close the print head mechanism. Make sure the latches are engaged securely.
7. Set the media sensor type and calibrate the selected sensor. (Please refer to section 3.1.2)

Note: Please calibrate the gap/black mark sensor when changing media.

● Loading path for fan-fold labels

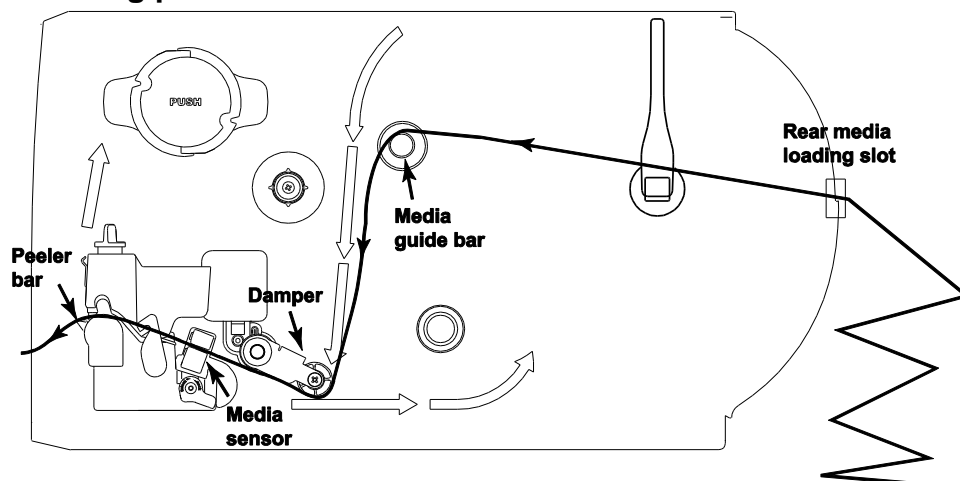

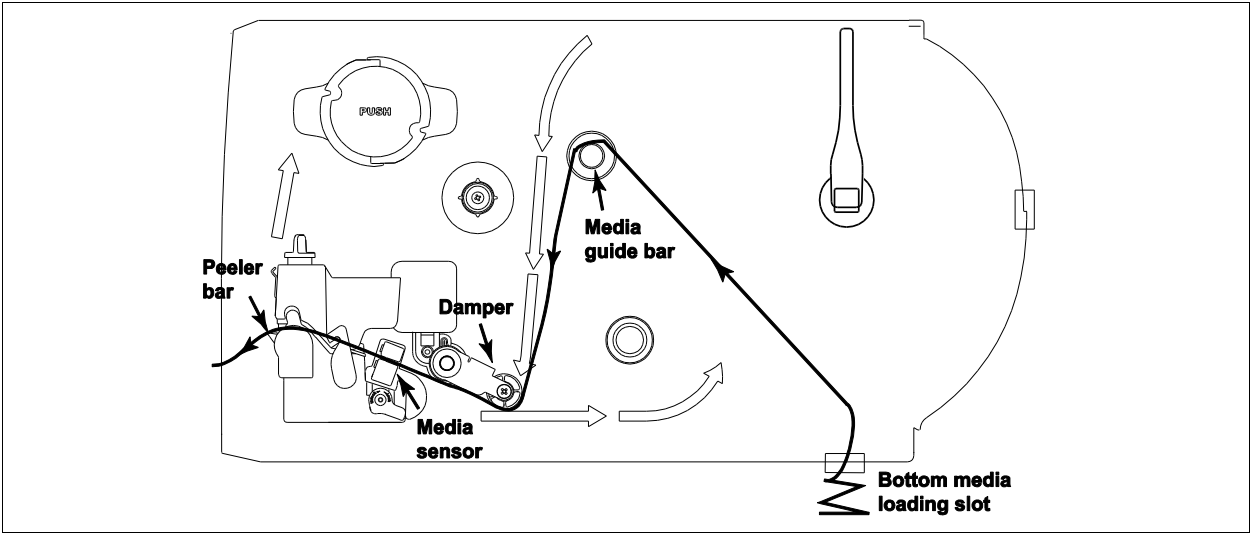

2.6.3 Loading Media in Peel-off Mode (Option)

1. Open the printer right side cover.
2. Push the print head release lever to open the print head mechanism.
3. Move the label roll guard horizontally to the end of label spindle then flip down the label roll guard.
4. Place the roll of media on the label supply spindle. Flip up the label roll guard. Move the label roll guard horizontally to fit the width of label roll.
5. Pull label roll leading edge forward through the media guide bar, damper media sensor and place the label leading edge onto the platen roller.
6. Adjust the label guide to fit the width of the label.
7. Using the front display panel, set the media sensor type and calibrate the selected sensor. (Please refer to section 3.1.2)
8. Then, pull approximately 650mm of label through the front of the printer.

9. Push down the peel-off roller release lever.

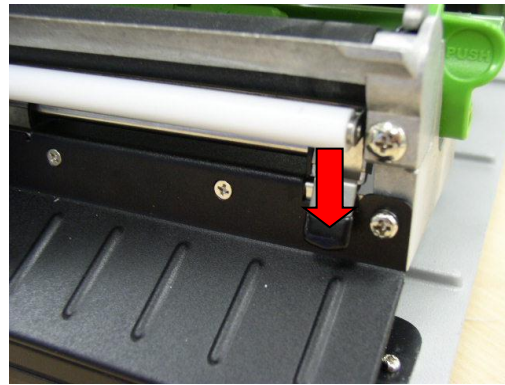

Peel-off roller
release lever

10. Feed the label between peel-off roller and platen roller.



Peel-off roller

11. Wrap the label onto the internal rewind spindle and wind the spindle counter-clockwise about 3~5 circles until the label is properly stretched.

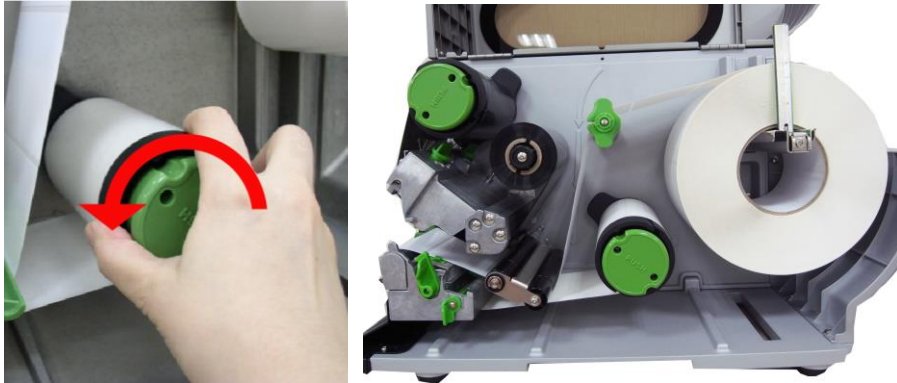

12. Lift up the peel-off roller release lever and close the print head mechanism.

13. Move the peel-off sensor toward the paper exit chute.

Peel-off sensor



14. Peeling will automatically start. Press the FEED button to test.

Label

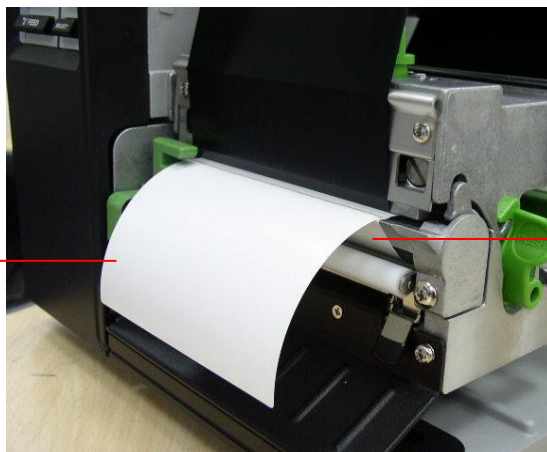

Liner

Note:

- * Please calibrate the gap/black mark sensor when changing media.
- * Please refer to videos on [TSC YouTube](#) or driver CD.

2.6.4 Remove Liner from Internal Rewind (Option)



1. Break the liner between peel-off roller and the internal rewind spindle.



2. Push the liner release button to release the liner on the internal rewind spindle.



3. Then, slide off the liner from internal rewind spindle.

2.6.5 Loading Media in Rewind Liner with Label Mode (Option)

This mode can rewind the media including liner and label on the rewind spindle.

1. Open the printer right side cover.
2. Insert the supply holder guide and paper core into the internal rewind for 1" core label roll.

Insert the supply holder guide, 3" label core adapter and paper core into the internal rewind for 3" core label roll.

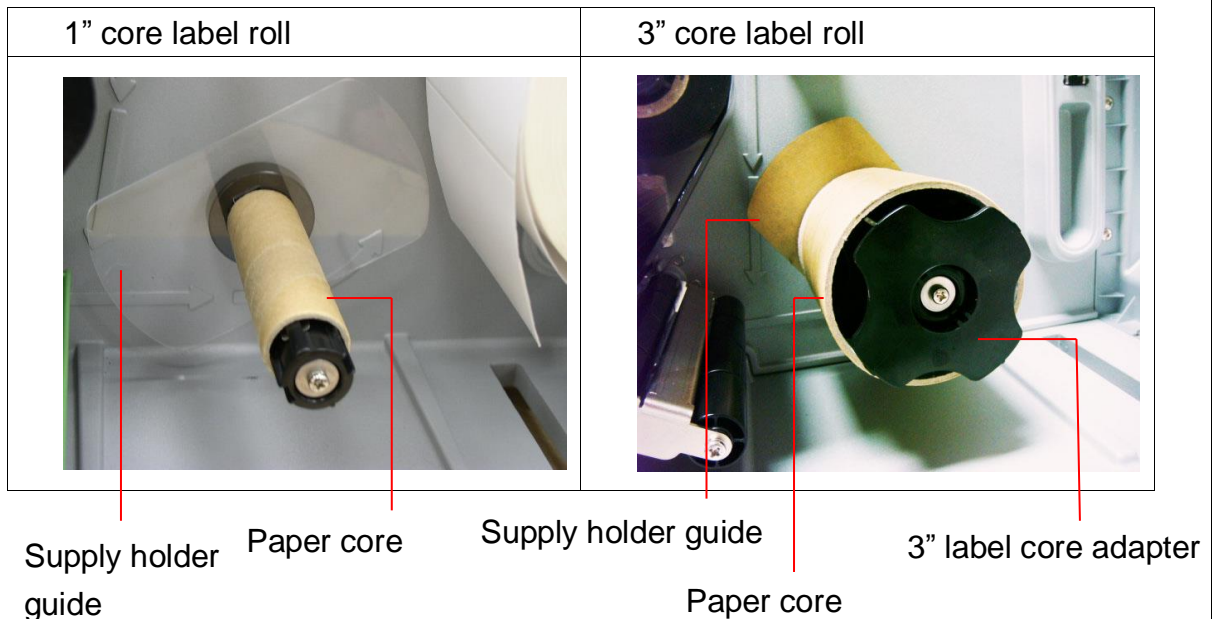

3. Insert media into the printer label spindle. Pull label roll leading edge forward through the media guide bar, damper media sensor and place the label leading edge onto the platen roller. (Please refer to section 2.6.1)
4. Then, pull approximately 650mm of label through the label redirect front panel.
5. Wrap the label onto the internal rewind spindle and stick the label onto the paper core.

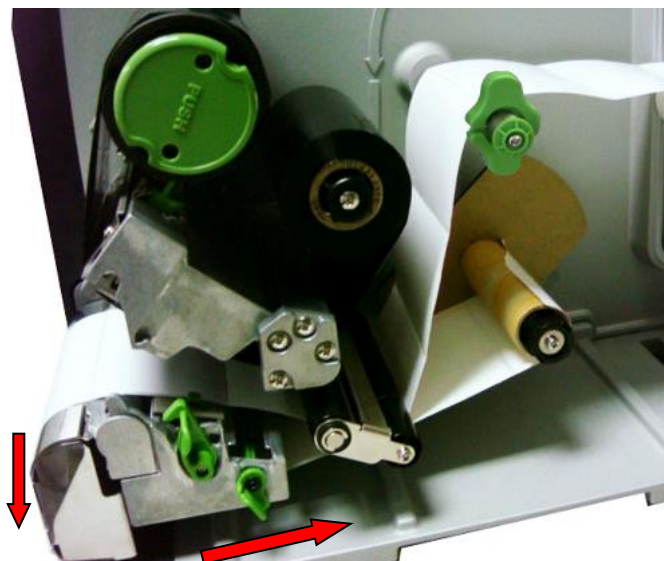

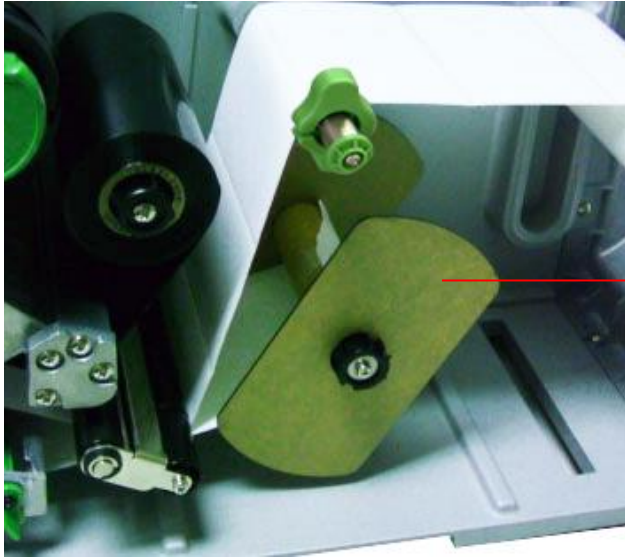

6. Insert another supply holder guide into the internal rewind for 1" core label roll.

Supply holder guide

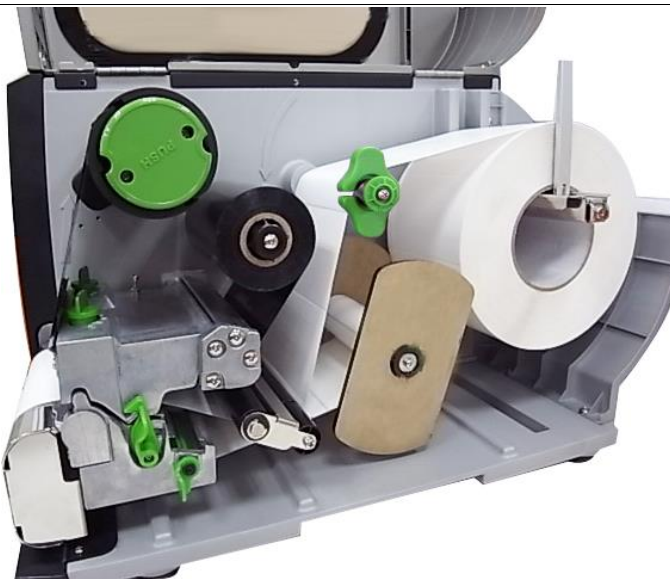

7. Using the LCD panel to set the media sensor type and calibrate the selected sensor. (Please refer to section 3.1.2)

Note:

- * Please calibrate the gap/black mark sensor when changing media.
- * Please refer to videos on [TSC YouTube](#) or driver CD.

2.6.6 Remove Labels from Internal Rewind (Option)

1. Slide off the labels with supply holder guides from internal rewind spindle.

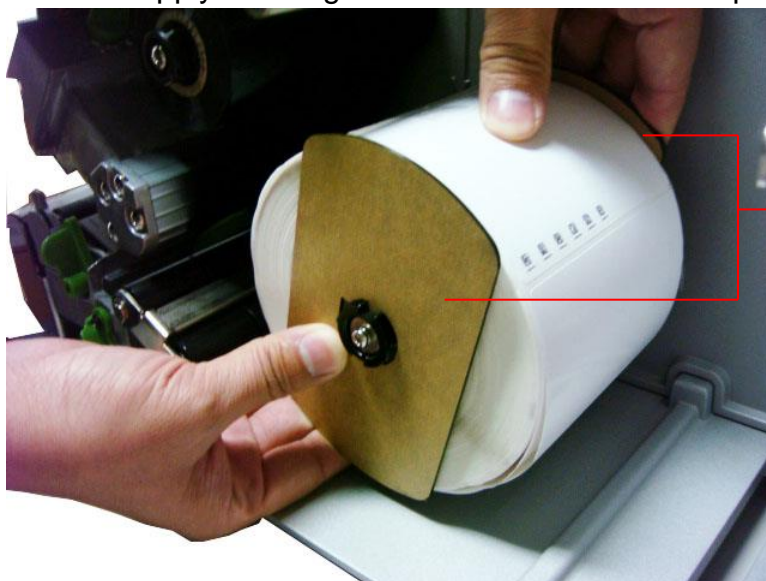

Supply holder
guides

2.7 Adjustment Knob

2.7.1 Print head Pressure Adjustment Knob

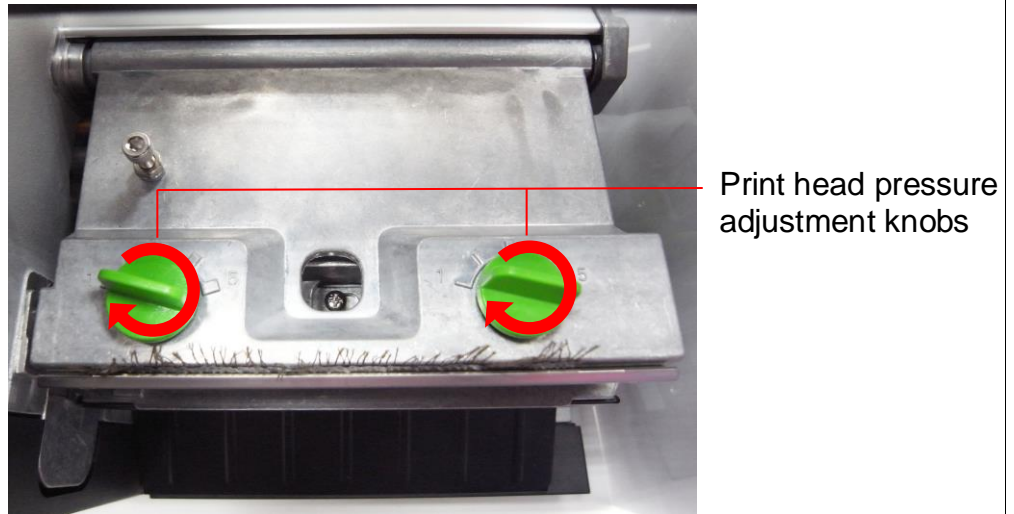

The print head pressure adjustment knob has 5 levels of adjustment. Because the printer's paper alignment is to the left side of mechanism, different media widths require different pressure to print correctly. Therefore it may require to adjust the pressure knob to get your best print quality. For example, if the label width is 4", adjust both print head pressure adjustment knobs to the same level. If the label is less than 2" wide, increase the left side print head pressure by rotating the adjustment knob clockwise and decrease the right side pressure by rotating the adjustment knob counter-clockwise to level 1.

2.7.2 Print Head Burn Line Adjustment Knob



The print head burn line adjustment knobs are used to fine tune the print quality for different thickness of media. Turning the knobs adjusts the print head's burn line forward or backward as it relates to the platen roller.

Caution: Incorrectly adjusting these knobs can lead to poor print quality and may cause damage to the printer. Proceed with caution.

The print head burn line default is set for general purpose printing media (plain paper and paper thickness less than 0.20mm).



Poor print quality when using paper thicker than 0.20mm may be due to the print head burn line not being at the optimized position. To improve the print quality, increase the head pressure or adjust the knobs counter-clockwise to move print head burn line toward the paper out direction then print again. Continue to adjust the burn line position and test print as necessary until the printout image is clear.

2.8 Using the Keyboard with PS/2 Interface (Optional for TTP-246M

Pro/TTP-344M Pro models)

1. Turn off the power of printer.
2. Plug the keyboard with PS/2 interface cable into PS/2 connector on the rear of the printer.
3. Turn on the printer.
4. After pressing the **F1** key of the keyboard, the LCD of printer will display as following.



```
File List      2/4
  DRAM
> FLASH
  CARD
```

5. Use up  or down  key of the keyboard to move “>” cursor and to select either DRAM, FLASH or CARD that you previously saved file in and press **Enter** key of the keyboard to list files.
6. Select the file and press **Enter** key to execute the .BAS file.

```
FLASH File List
  TEST1.BAS
> TEST2.BAS
  TEST3.BAS
```

7. Then, you can type the words or the number of the copy from keyboard by your .BAS file program.

Press **F1** key of the keyboard to start this function.

Press up  or down  key of the keyboard to move cursor of printer LCD display to select the option.

Press **Esc** key of the keyboard to return the previous menu.

Press **Enter** key of the keyboard to enter/execute cursor located option.

Press **Ctrl + C** keys of the keyboard to restart the printer and back to “Ready” state.

Note: PS/2 interface is a standard interface for TTP-2410M Pro/TTP-346M Pro models, but optional for TTP-246M Pro/TTP-344M Pro models.

3. Menu Function

Main Menu Overview

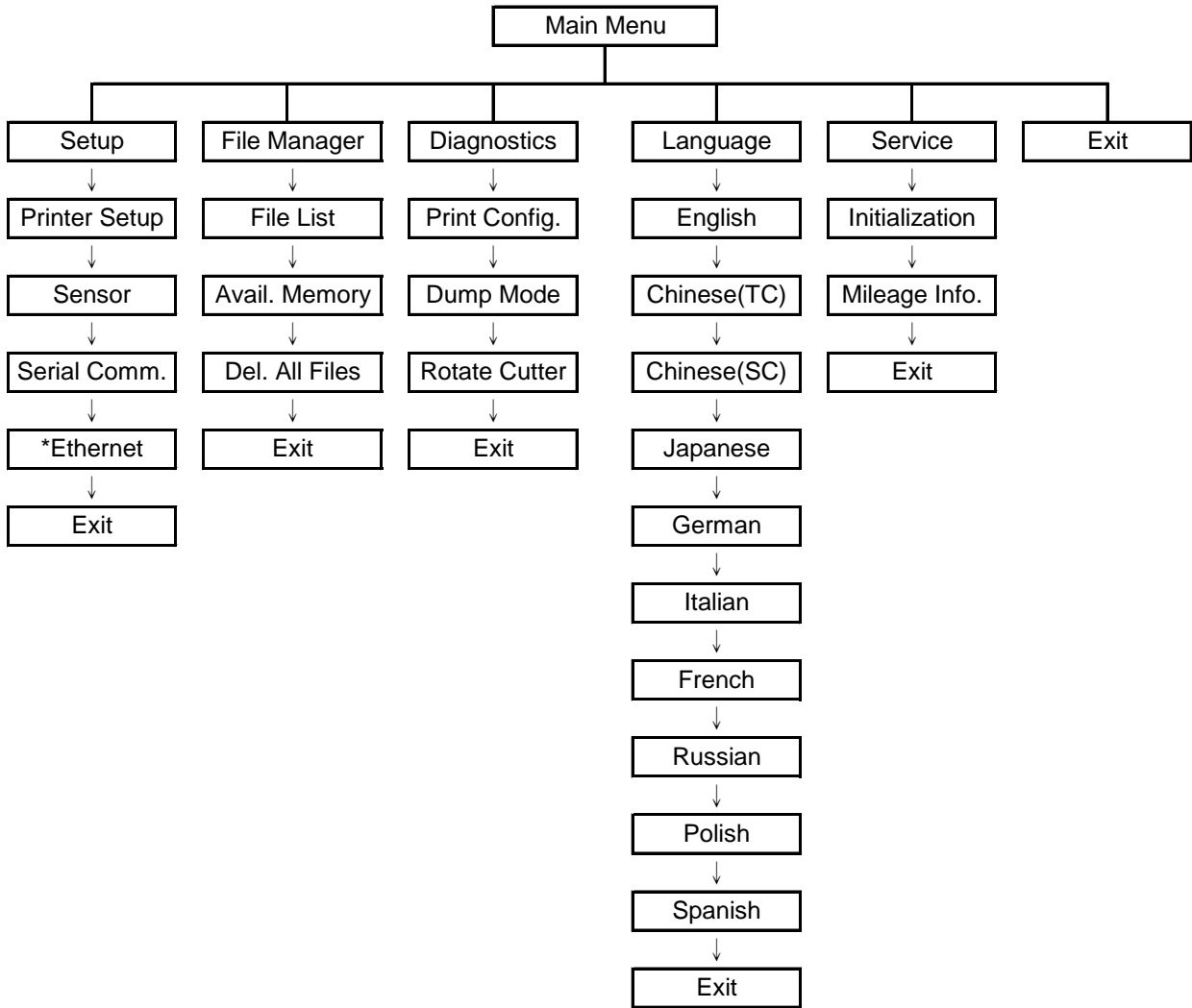

Notice:

* The Ethernet function is available for TTP-2410M Pro series only and option for TTP-246M Pro series.

* Ethernet function is available on the LCD display when Ethernet card is installed.

3.1 Setup Menu Overview

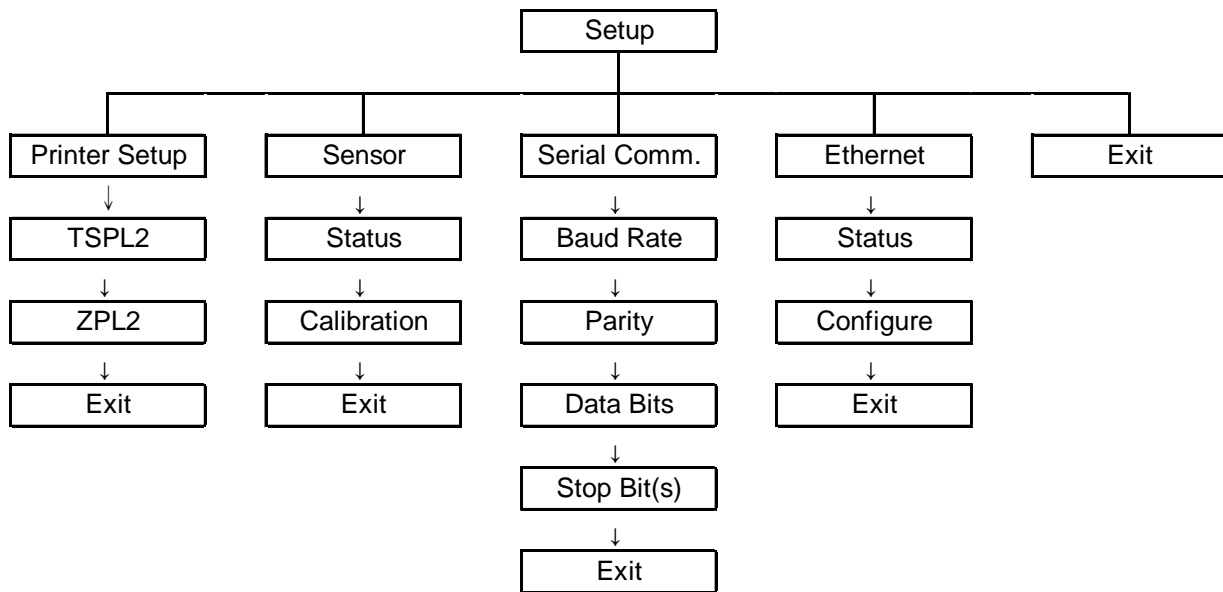

Notice:

- * The Ethernet function is available for TTP-2410M Pro series only and option for TTP-246M Pro series.
- * Ethernet function is available on the LCD display when Ethernet card is installed.

3.1.1-1 Printer Setup (TSPL2)

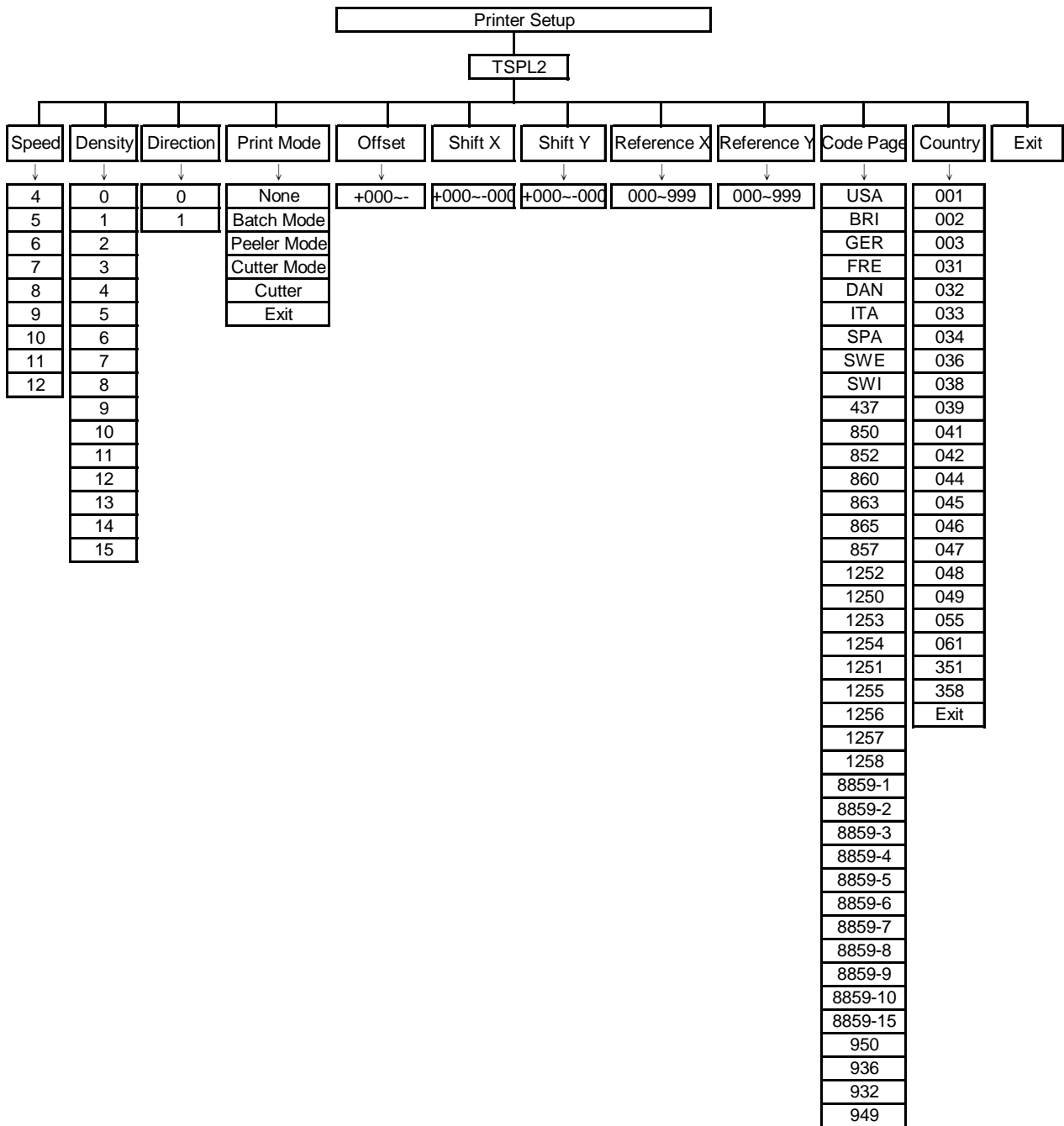

3.1.1-1.1 Speed:

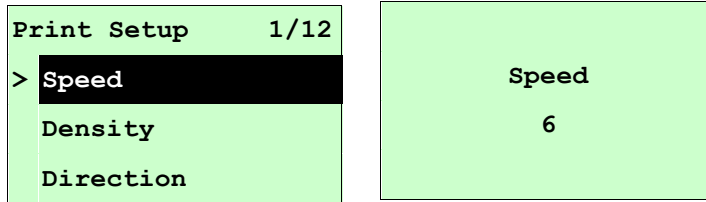

Use this option to setup print speed. The each increment/decrement is 1 ips. Press **UP** ⏴ key to raise the print speed, and press **DOWN** ⏵ key to decrease print speed. Press **SELECT** key to set it into printer. Press **MENU** key to cancel the setting and return to the previous menu.

Note: If printing from enclosed software/driver, the software/driver will send out the SPEED command, which will overwrite the setting set from the front panel.

3.1.1-1.2 Density:

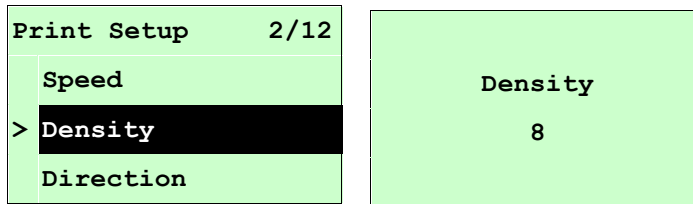

Use this option to setup printing darkness. The available setting is from 0 to 15, and the step is 1. Printer default density is 8. You may need to adjust your density based on selected media.

Press **UP** ⏴ and **DOWN** ⏵ to increase/decrease the printing darkness. Press **SELECT** key to enable the setting. Press **MENU** key to cancel the setting and return to the previous menu.

Note: If printing from enclosed software/driver, the software/driver will send out the DENSITY command, which will overwrite the setting set from the front panel.

3.1.1-1.3 Direction:

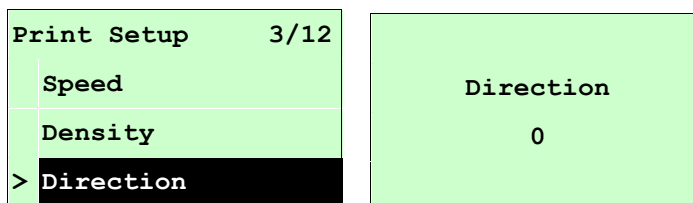

The direction setting value is either 1 or 0. Use this option to setup the printout direction. Printer default printout direction is DIRECTION 0.

Press **UP** ⏴ key to set the direction as 1, and **DOWN** ⏵ to set it as 0, and **SELECT** key to enable the setting. Press **MENU** key to cancel the setting and

return to the previous menu.

The following 2 figures are the printouts of DIRECTION 0 and 1 for your reference.

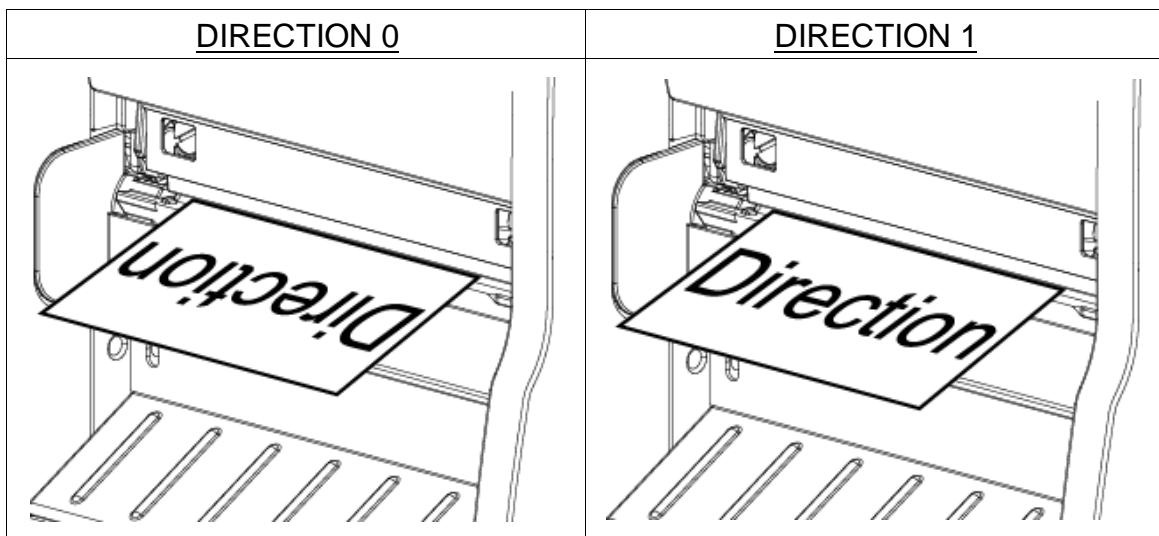

Note: If printing from enclosed software/driver, the software/driver will send out the command, which will overwrite the setting set from the front panel.

3.1.1-1.4 Print Mode: (None/Batch Mode/Peeler Mode/Cutter Mode/Cutter Batch)

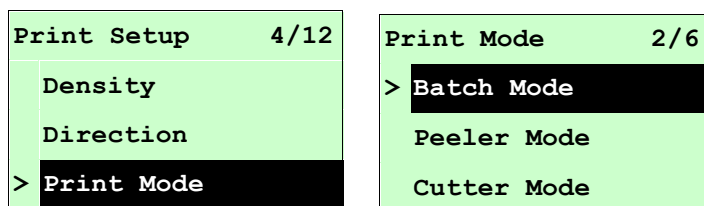

This option is used to set the print mode. Printer default setting is Batch Mode. When enter this list, the print mode in the right side of “>” icon is the printer current setting. Press **UP** and **DOWN** to select the different print mode and press **SELECT** button to enable the setting. Press **MENU** key to cancel the setting and return to the previous menu.

Printer Mode	Description
None	Next label top of form is aligned to the print head burn line location. (Tear Off Mode)
Batch Mode	Once image is printed completely, label gap/black mark will be fed to the tear plate location for tear away.
Peeler Mode	Enable the label peel off mode.
Cutter Mode	Enable the label cutter mode.

Cutter Batch	Cut the label once at the end of the printing job.
--------------	--

Note: If printing from enclosed software/driver, the software/driver will send out the command, which will overwrite the setting set from the front panel.

3.1.1-1.5 Offset:

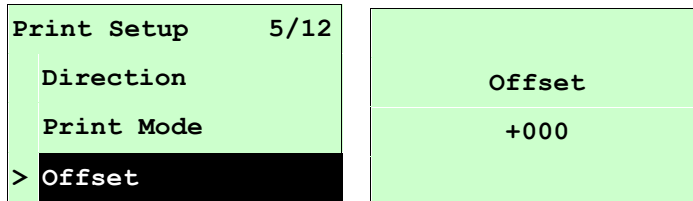

This option is used to fine tune media stop location. Press the **DOWN** Ⓞ button to move the cursor from left digit to right digit, and press the **UP** Ⓞ button to set the value from “+” to “-” or “0” to “9”. Press the **SELECT** button to set the value into printer. Press **MENU** key to cancel the setting and return to the previous menu. The default value is +000.

Note: If printing from enclosed software/driver, the software/driver will send out the OFFSET command, which will overwrite the setting set from the front panel.

3.1.1-1.6 Shift X & Shift Y:

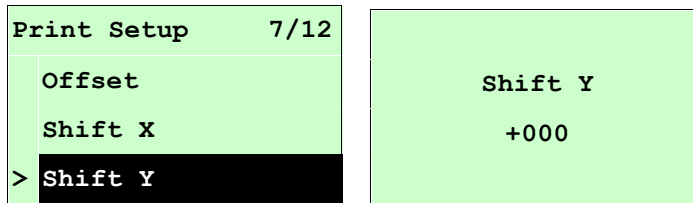

This option is used to fine tune print position. Press the **DOWN** Ⓞ button to move the cursor from left digit to right digit, and press the **UP** Ⓞ button to set the value from “+” to “-” or “0” to “9”. Press the **SELECT** button to set the value into printer. Press **MENU** key to cancel the setting and return to the previous menu. The default value is +000.

Note: If printing from enclosed software/driver, the software/driver will send out the SHIFT command, which will overwrite the setting set from the front panel.

3.1.1-1.7 Reference X & Reference Y:

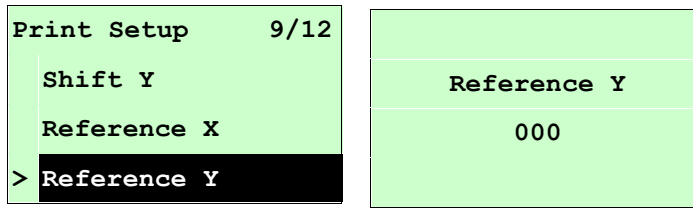

This option is used to set the origin of printer coordinate system horizontally and vertically. Press the **DOWN** Ⓞ button to move the cursor from left digit to right digit, and press the **UP** Ⓞ button to set the value from “0” to “9”. Press the **SELECT** button to set the value into printer. Press **MENU** key to cancel the setting and return to the previous menu. The default value is 000.

Note: If printing from enclosed software/driver, the software/driver will send out the REFERENCE command, which will overwrite the setting set from the front panel.

3.1.1-1.8 Code Page:

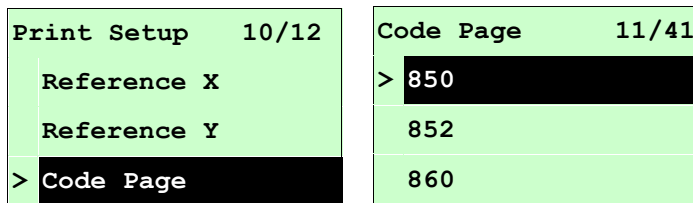

Use this option to set the code page of international character set. For more information about code page, please to refer the programming manual. When enter the code page list, the code page in the right side of “>” icon is the printer current setting.

Press the **UP** Ⓞ and **DOWN** Ⓞ to select the code page, and press the **SELECT** button to enable the setting. Press **MENU** key to cancel the setting and return to the previous menu.

Note: If printing from enclosed software/driver, the software/driver will send out the command, which will overwrite the setting set from the front panel.

7-bit		8-bit	
code page name	International Character Set	code page number	International Character Set
USA	USA	437	United States
BRI	British	850	Multilingual
GER	German	852	Slavic
FRE	French	860	Portuguese
DAN	Danish	863	Canadian/French

ITA	Italian	865	Nordic
SPA	Spanish		
SWE	Swedish		
SWI	Swiss		

Windows Code Page (SBCS)		Windows Code Page (DBCS)	
code page number	International Character Set	code page number	International Character Set
1252	Latin 1	950	Traditional Chinese Big5
1250	Central Europe	936	Simplified Chinese GBK
1253	Greek	932	Japanese Shift-JIS
1254	Turkish	949	Korean
1251	Cyrillic		
1255	Hebrew		
1256	Arabic		
1257	Baltic		
1258	Vietnam		

ISO Code Page		ISO Code Page	
code page name	International Character Set	code page number	International Character Set
8859-1	Latin 1	8859-7	Greek
8859-2	Latin 2	8859-9	Turkish
8859-3	Latin 3	8859-10	Latin 6
8859-4	Baltic	8859-15	Latin 9
8859-5	Cyrillic		

3.1.1-1.9 Country:

Print Setup 11/12	Country 1/23
Reference Y	> 001
Code Page	002
> Country	003

Use this option to set the country code for the LCD display. Press the **UP** ⬆ and **DOWN** ⬇ to select the country code, and press the **SELECT** button to set the value

into printer. When enter this list, the country code in the right side of “>” icon is the printer current setting. Press  **MENU** key to cancel the setting and return to the previous menu.

Code	Country	Code	Country	Code	Country	Code	Country
001	USA	034	Spanish (Spain)	044	United Kingdom	055	Brazil
002	Canadian-French	036	Hungarian	045	Danish	061	English (International)
003	Spanish (Latin America)	038	Yugoslavian	046	Swedish	351	Portuguese
031	Dutch	039	Italian	047	Norwegian	358	Finnish
032	Belgian	041	Switzerland	048	Polish		
033	French (France)	042	Slovak	049	German		

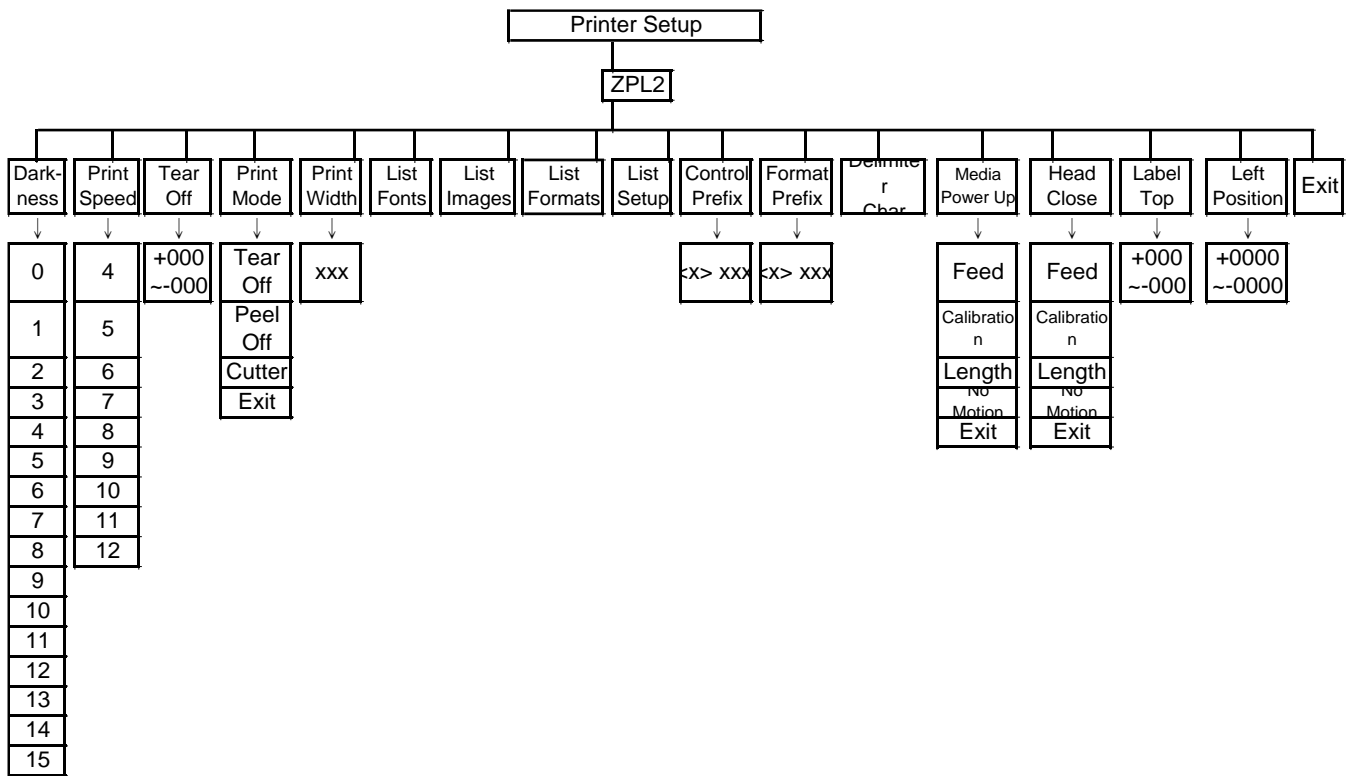

3.1.1-2 Printer Setup (ZPL2)

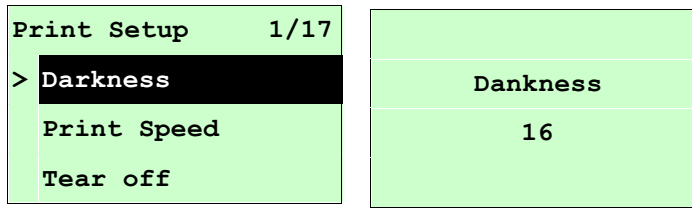

3.1.1-2.1 Darkness:







Use this option to setup printing darkness. The available setting is from 0 to 30, and the step is 1. Printer default density is 16. You may need to adjust your density based on selected media.

Press **UP**  and **DOWN**  to increase/decrease the printing darkness. Press **SELECT** key to enable the setting. Press  **MENU** key to cancel the setting and return to the previous menu.

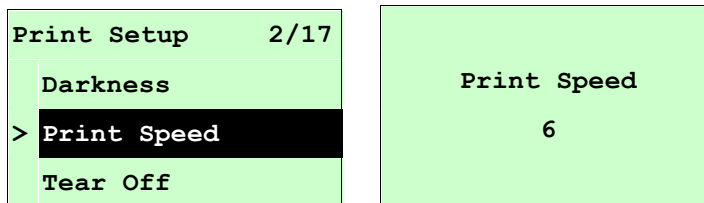
Note: If printing from enclosed software/driver, the software/driver will send out the command, which will overwrite the setting set from the front panel.

3.1.1-2.2 Print Speed:





Use this option to setup print speed. The each increment/decrement is 1 ips. Press **UP**  key to raise the print speed, and press **DOWN**  key to decrease print speed. Press **SELECT** key to set it into printer. Press  **MENU** key to cancel the setting and return to the previous menu.

Note: If printing from enclosed software/driver, the software/driver will send out the command, which will overwrite the setting set from the front panel.

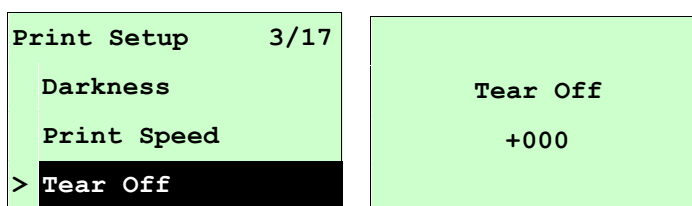
3.1.1-2.3 Tear Off:







This option is used to fine tune media stop location. Press the **DOWN**  button to

move the cursor from left digit to right digit, and press the **UP**  button to set the value from “+” to “-” or “0” to “9”. Press the **SELECT** button to set the value into printer. Press  **MENU** key to cancel the setting and return to the previous menu. The default value is +000.

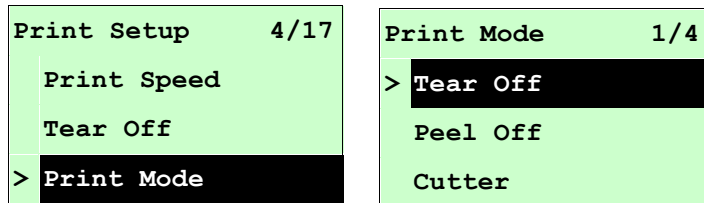
Note: If printing from enclosed software/driver, the software/driver will send out the command, which will overwrite the setting set from the front panel.

3.1.1-2.4 Print Mode: (Tear Off / Peel Off / Cutter)





This option is used to set the print mode. Printer default setting is Tear Off. When enter this list, the print mode in the right side of “>” icon is the printer current setting. Press **UP**  and **DOWN**  to select the different print mode and press **SELECT** button to enable the setting. Press  **MENU** key to cancel the setting and return to the previous menu.

Printer Mode	Description
Tear Off	Next label top of form is aligned to the print head burn line location.
Peel Off	Enable the label peel off mode.
Cutter	Enable the label cutter mode.

Note: If printing from enclosed software/driver, the software/driver will send out the command, which will overwrite the setting set from the front panel.

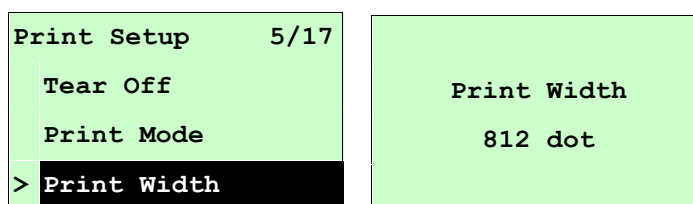
3.1.1-2.5 Print Width:



This option is used to set print width. Press the **DOWN**  button to move the cursor from left digit to right digit, and press the **UP**  button to set the value from “0” to

“9” or “dot” to “mm”. Press the **SELECT** button to set the value into printer. Press **MENU** key to cancel the setting and return to the previous menu.

Note: If printing from enclosed software/driver, the software/driver will send out the command, which will overwrite the setting set from the front panel.

3.1.1-2.6 List Fonts:

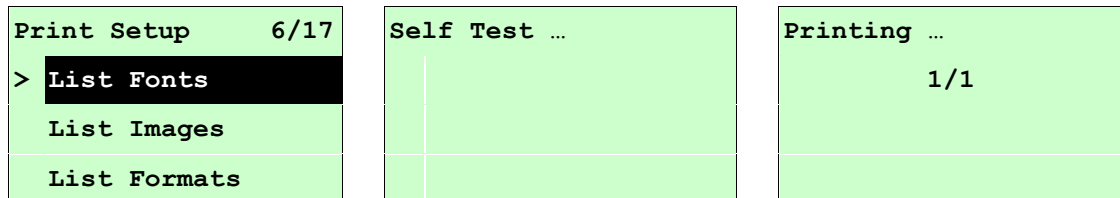

This feature is used to print current printer available fonts list to the label. The fonts stored in the printer’s DRAM, Flash or optional memory card. Press **SELECT** button to print the list.

3.1.1-2.7 List Images:

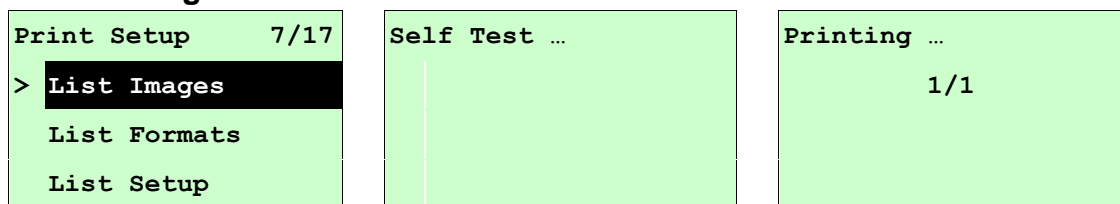

This feature is used to print current printer available images list to the label. The images stored in the printer’s DRAM, Flash or optional memory card. Press **SELECT** button to print the list.

3.1.1-2.8 List Formats:

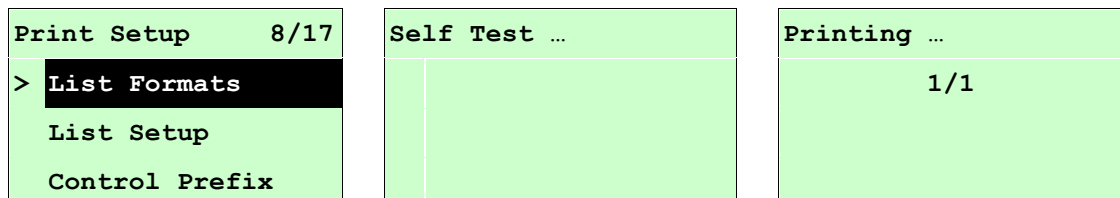

This feature is used to print current printer available formats list to the label. The formats stored in the printer’s DRAM, Flash or optional memory card. Press **SELECT** button to print the list.

3.1.1-2.9 List Setup:

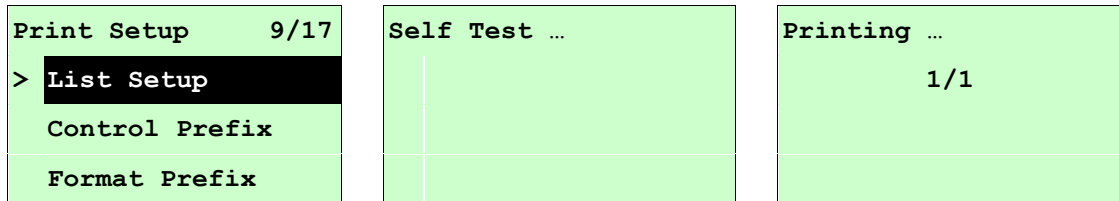

This feature is used to print current printer configuration to the label. Press **SELECT** button to print the list.

3.1.1-2.10 Control Prefix:

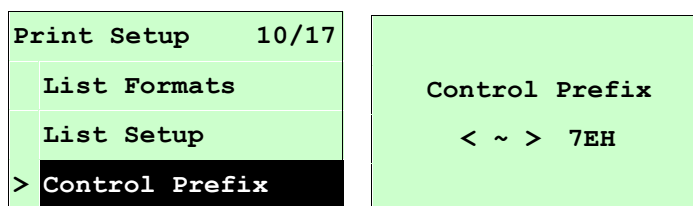

This option is used to set control prefix character. Press the **DOWN** Ⓞ button to move the cursor from left digit to right digit, and press the **UP** Ⓞ button to set the value from “0” to “9” or “A” to “F”. Press the **SELECT** button to set the value into printer. Press **MENU** key to cancel the setting and return to the previous menu.

3.1.1-2.11 Format Prefix:

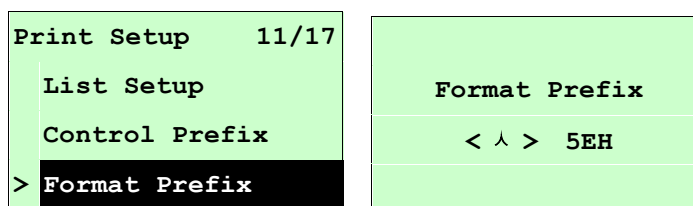

This option is used to set format prefix character. Press the **DOWN** Ⓞ button to move the cursor from left digit to right digit, and press the **UP** Ⓞ button to set the value from “0” to “9” or “A” to “F”. Press the **SELECT** button to set the value into printer. Press **MENU** key to cancel the setting and return to the previous menu.

3.1.1-2.12 Delimiter Char:

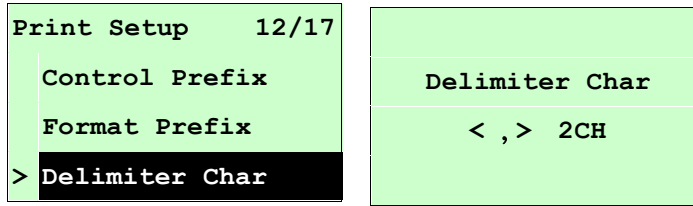

This option is used to set delimiter character. Press the **DOWN** Ⓞ button to move the cursor from left digit to right digit, and press the **UP** Ⓞ button to set the value from “0” to “9” or “A” to “F”. Press the **SELECT** button to set the value into printer. Press **MENU** key to cancel the setting and return to the previous menu.

3.1.1-2.13 Media Power Up:

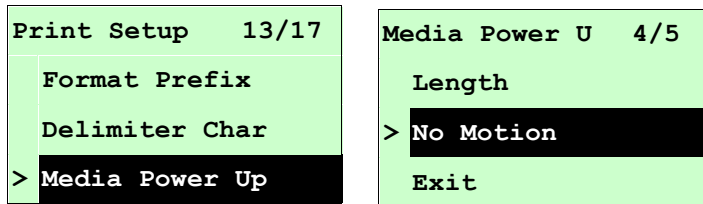

This option is used to set the action of the media when you turn on the printer. Printer default setting is No Motion. When enter this list, the print mode in the right side of “>” icon is the printer current setting. Press **UP** Ⓞ and **DOWN** Ⓞ to select the different print mode and press **SELECT** button to enable the setting. Press **MENU** key to cancel the setting and return to the previous menu.

Selections	Description
Feed	Printer will advance one label
Calibration	Printer will calibration the sensor levels, determine length and feed label
Length	Printer determine length and feed label
No Motion	Printer will not move media

3.1.1-2.14 Head Close:

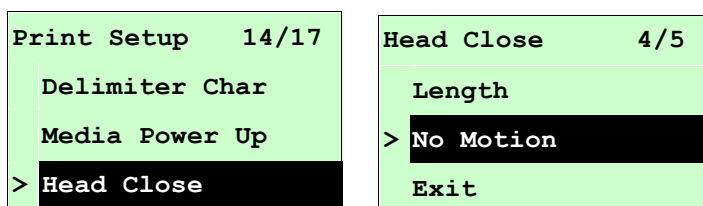

This option is used to set the action of the media when you close the printhead. Printer default setting is No Motion. When enter this list, the print mode in the right side of “>” icon is the printer current setting. Press **UP** Ⓞ and **DOWN** Ⓞ to select the different print mode and press **SELECT** button to enable the setting. Press **MENU** key to cancel the setting and return to the previous menu.

Selections	Description
Feed	Printer will advance one label
Calibration	Printer will calibration the sensor levels, determine length and feed label
Length	Printer determine length and feed label
No Motion	Printer will not move media

3.1.1-2.15 Label Top:

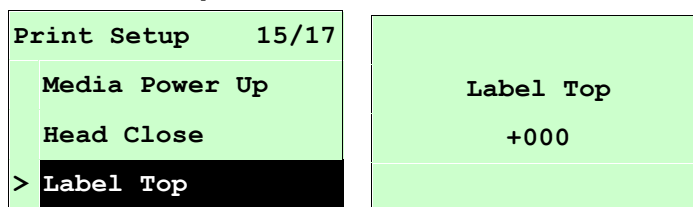

This option is used to adjust print position vertically on the label. Press the **DOWN** Ⓞ button to move the cursor from left digit to right digit, and press the **UP** Ⓞ button to set the value from “+” to “-” or “0” to “1/2”. Press the **SELECT** button to set the value into printer. Press **MENU** key to cancel the setting and return to the previous menu. The default value is +000 and range is -120 to +120 dots.

3.1.1-2.16 Left Position:

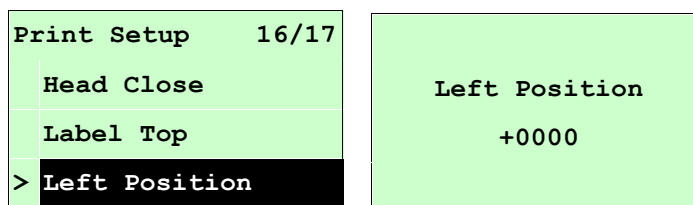

This option is used to adjust print position horizontally on the label. Press the **DOWN** Ⓞ button to move the cursor from left digit to right digit, and press the **UP** Ⓞ button to set the value from “+” to “-” or “0” to “9”. Press the **SELECT** button to set the value into printer. Press **MENU** key to cancel the setting and return to the previous menu. The default value is +0000 and range is -9999 to +9999 dots.

3.1.2 Sensor

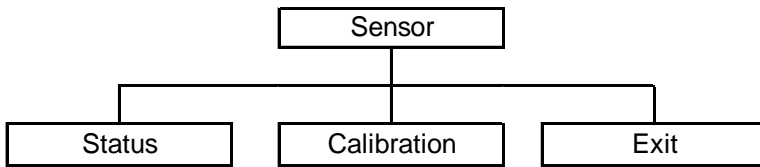

3.1.2.1 Status

This function is available to check the printer's sensor status. When enter the [Status] option, you will see following message.

Paper Len.	812
Gap Size	24
Intensity	3
Ref. Level	512

3.1.2.2 Calibration

This option is used to set the media sensor type and calibrate the selected sensor. We recommend to calibrate the sensor before printing when changing the media.

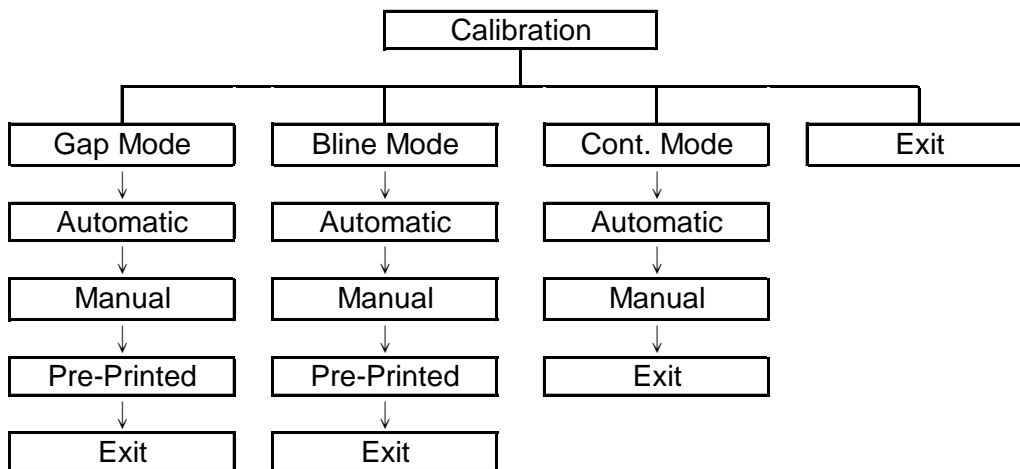

A. Gap Mode

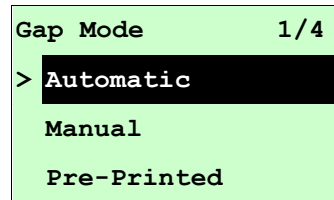
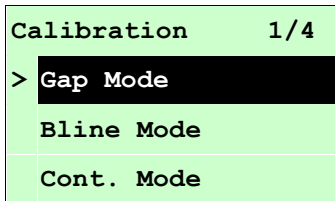

Press the **UP** ⤴ and **DOWN** ⤵ buttons to scroll the cursor to the media type and press the **SELECT** button to enter the sensor calibration mode.

Note: If printing from enclosed software/driver, the software/driver will send out the GAP or BLINE command, which will overwrite the sensor type setting set from the front panel.

A-1 Automatic

When enter the [Automatic] option, you will see following message, and printer will feed 2 to 3 gap labels to calibrate the sensor sensitivity automatically. When calibration is completed, the LCD screen will return to the previous menu.

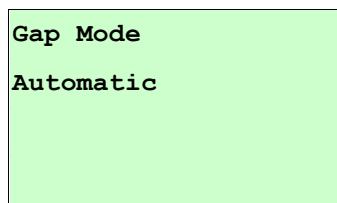

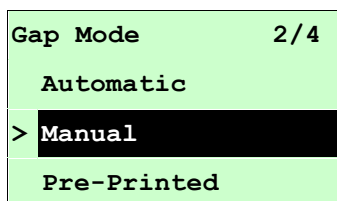

A-2 Manual

In case “Automatic” sensor calibration cannot apply to the media, please use “Manual” function to calibrate the gap sensor manually.

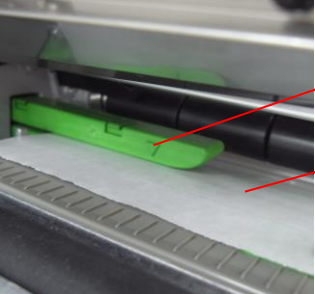

When enter [Manual] option, you will see following message. Please complete there steps :

<p>Paper Len. 00812 dot</p>	<ol style="list-style-type: none">1. Press the DOWN ⤵ button to move the cursor from left digit to right digit, and press the UP ⤴ button to set the value from “0” to “9” and the “dot/mm/ inch”. Press the SELECT button to set the paper length into the printer.
---------------------------------	---

<p style="text-align: center;">Gap Size 0024 dot</p>	<p>2. Press the DOWN Ⓞ button to move the cursor from left digit to right digit, and press the UP Ⓞ button to set the value from “0” to “9” and the “dot/mm/ inch”. Press the SELECT button to set the gap size into the printer.</p>
<p>Gap Mode Scan Backing Intensity x Ref. Level xxx</p>	<p>3. Open the print head mechanism, put the label backing (liner) under the media sensor. Press the SELECT button to set the value into the printer.</p>
	<p>Media sensor Label backing (liner)</p>
<p>Gap Mode Scan Paper Intensity x Ref. Level xxx</p>	<p>4. Then, Put the label with liner under the media sensor. Press the SELECT button to set the value into the printer.</p>
	<p>Media sensor Label with liner</p>
<p>Gap Mode Complete Intensity x Ref. Level xxx</p>	<p>5. The gap sensor calibration is complete. Press the SELECT button the LCD screen will return to the previous menu.</p>

A-3 Pre-Printed

This function can set the paper length and gap size before auto-calibrate the sensor sensitivity. It can to get the sensor sensitivity accurately.

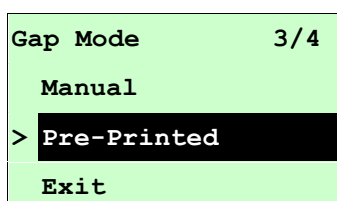

When enter [Pre-Printed] option, you will see following message. Please complete there steps :

<p>Paper Len.</p> <p>00812 dot</p>	<p>1. Press the DOWN Ⓞ button to move the cursor from left digit to right digit, and press the UP Ⓞ button to set the value from “0” to “9” and the “dot/mm/ inch”. Press the SELECT button to set the paper length into the printer.</p>
<p>Gap Size</p> <p>0024 dot</p>	<p>2. Press the DOWN Ⓞ button to move the cursor from left digit to right digit, and press the UP Ⓞ button to set the value from “0” to “9” and the “dot/mm/ inch”. Press the SELECT button to set the gap size into the printer.</p>
<p>Gap Mode</p> <p>Pre-Printed</p>	<p>3. Then, printer will feed labels to calibrate the sensor sensitivity automatically. When calibration is completed, the LCD screen will return to the previous menu.</p>

B. Bline Mode

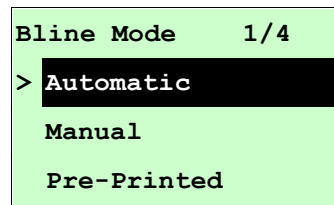
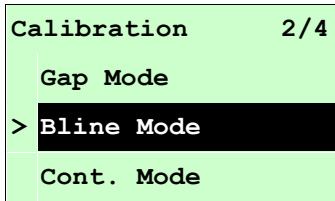

Press the **UP** ⤴ and **DOWN** ⤵ buttons to scroll the cursor to the sensor type. Press the **SELECT** button to enter the black-mark sensor calibration mode.

B-1 Automatic

When enter the [Automatic] option, you will see following message and printer will feed the black mark label to calibrate the sensor sensitivity automatically. When calibration process is completed, the LCD screen will return to the previous menu.

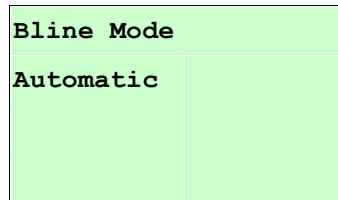

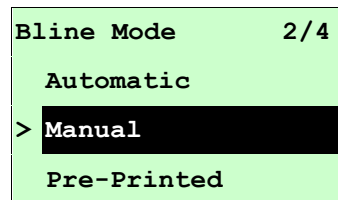

B-2 Manual

In case “Automatic” sensor calibration cannot apply to the media, please use “Manual” function to calibrate the bline sensor manually.

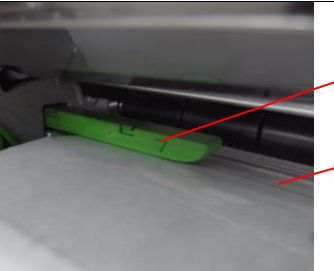

When enter [Manual] option, you will see following message. Please complete there steps :

<p>Paper Len. 00151 dot</p>	<p>1. Press the DOWN ⤵ button to move the cursor from left digit to right digit, and press the UP ⤴ button to set the value from “0” to “9” and the “dot/mm/ inch”. Press the SELECT button to set the paper length into the printer.</p>
<p>Bline Size 0024 dot</p>	<p>2. Press the DOWN ⤵ button to move the cursor from left digit to right digit, and press the UP ⤴ button to set the value from “0” to “9” and the “dot/mm/ inch”. Press the SELECT button to set the bline size into the printer.</p>

<pre> Bline Mode Scan Mark Intensity x Ref. Level xxx </pre>	<p>3. Open the print head mechanism, put the black mark under the media sensor. Press the SELECT button to set the value into the printer.</p>
	<p>Media sensor</p> <p>Black mark</p>
<pre> Bline Mode Scan Paper Intensity x Ref. Level xxx </pre>	<p>4. Then, put the label without black mark under the media sensor. Press the SELECT button to set the value into the printer.</p>
	<p>Media sensor</p> <p>Label without black mark</p>
<p>Note: Normally, the value of "Ref. Level" for mark should be larger than paper for over 128. If the media sensor fails to do so, you have to manually change the Intensity by pressing UP ⤴ and DOWN ⤵ to reach the above value.</p>	
<pre> Bline Mode Complete Intensity x Ref. Level xxx </pre>	<p>5. The bline sensor calibration is complete. Press the SELECT button the LCD screen will return to the previous menu.</p>

B-3 Pre-Printed

This function can set the paper length and gap size before auto-calibrate the sensor sensitivity. It can to get the sensor sensitivity accurately.

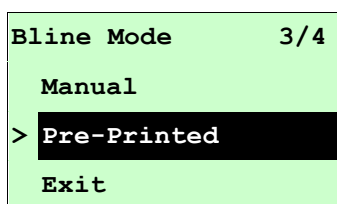

When enter [Pre-Printed] option, you will see following message. Please

complete these steps :

<p>Paper Len. 00812 dot</p>	<p>1. Press the DOWN Ⓞ button to move the cursor from left digit to right digit, and press the UP Ⓞ button to set the value from “0” to “9” and the “dot/mm/ inch”. Press the SELECT button to set the paper length into the printer.</p>
<p>Bline Size 0024 dot</p>	<p>2. Press the DOWN Ⓞ button to move the cursor from left digit to right digit, and press the UP Ⓞ button to set the value from “0” to “9” and the “dot/mm/ inch”. Press the SELECT button to set the bline size into the printer.</p>
<p>Bline Mode Pre-Printed</p>	<p>3. Then, printer will feed labels to calibrate the sensor sensitivity automatically. When calibration is completed, the LCD screen will return to the previous menu.</p>

C. Cont. Mode

```

Calibration      3/4
  Bline Mode
> Cont. Mode
  Exit
  
```

```

Cont. Mode      1/3
> Automatic
  Manual
  Exit
  
```

Press the **UP** ⬆ and **DOWN** ⬇ buttons to scroll the cursor to the sensor type. Press the **SELECT** button to enter the black-mark sensor calibration mode.

C-1 Automatic

When enter the [Automatic] option, you will see following message and printer will calibrate the sensor sensitivity automatically. When calibration process is completed, the LCD screen will return to the previous menu.

```

Cont. Mode
Automatic
  
```

C-2 Manual

In case “Automatic” sensor calibration cannot apply to the media, please use “Manual” function to calibrate the sensor manually.

```

Cont. Mode      2/3
  Automatic
> Manual
  Exit
  
```

When enter [Manual] option, you will see following message. Please complete there steps :

<pre> Cont. Mode Remove Label Intensity x Ref. Level xxx </pre>	<p>2. Remove the continuous label. Press the SELECT button to set the value into the printer.</p>
<pre> Cont. Mode Scan Paper Intensity x Ref. Level xxx </pre>	<p>2. Then, put the continuous label under the media sensor. Press the SELECT button to set the value into the printer.</p>

Cont. Mode	
Complete	
Intensity	x
Ref. Level	xxx

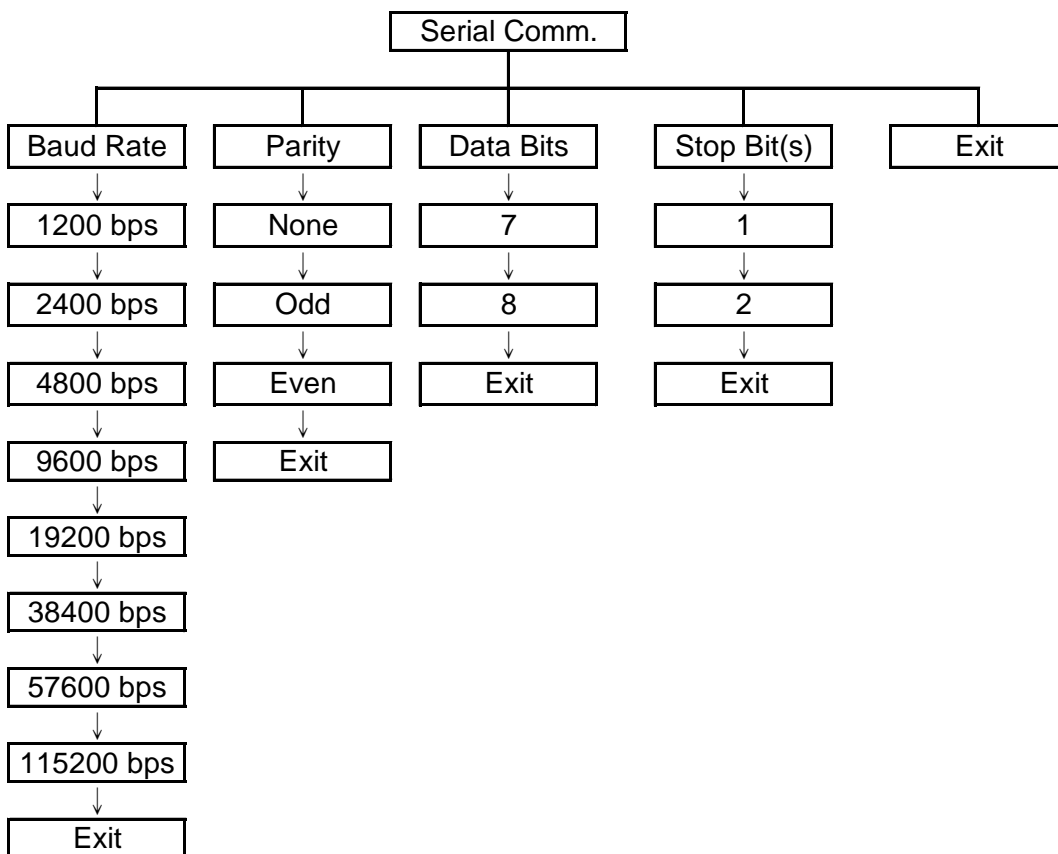

3. The sensor calibration is complete.
Press the **SELECT** button the LCD screen will return to the previous menu.

3.1.3 Serial Comm.



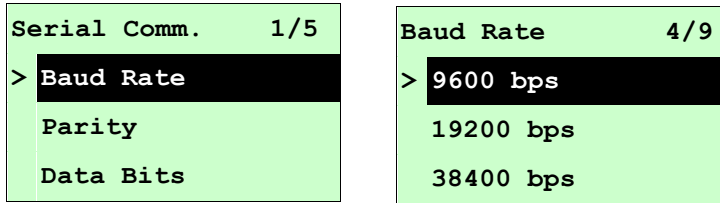



3.1.3.1 Baud Rate

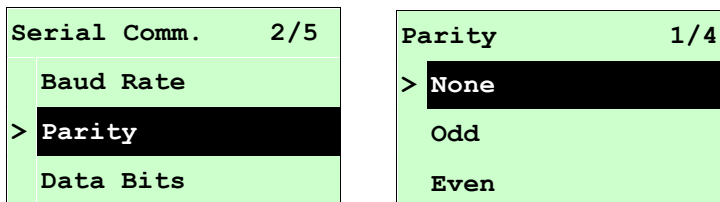

This option is used to set the RS-232 baud rate. The default setting is 9600 bps. Press **UP**  and **DOWN**  buttons to select the different baud rate and press **SELECT** button to set the value into printer. When you enter this list, the baud rate value in the right side of “>” icon is the current setting in the printer. Press  **MENU** key to cancel the setting and return to the previous menu.



3.1.3.2 Parity



This option is used to set the RS-232 parity. The default setting is “None”. Press **UP**  and **DOWN**  buttons to select the different parity and press **SELECT** button to set the value into printer. When you enter this list, the parity in the right side of “>” is the printer current setting. Press  **MENU** key to cancel the setting and return to the previous menu.

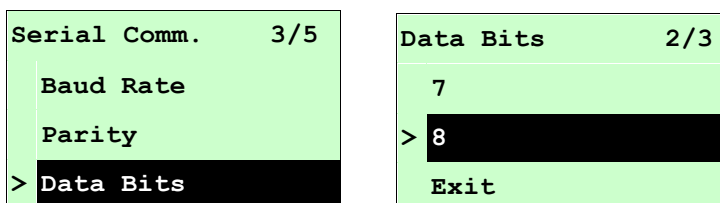

3.1.3.3 Data Bits:



This option is used to set the RS-232 Data Bits. The default setting is “8” data bits. Press **UP**  and **DOWN**  buttons to select the different Data Bits and press **SELECT** button to set the value into printer. When you enter this list, the Data Bits in the right side of “>” icon is the printer current setting. Press  **MENU** key to cancel the setting and return to the previous menu.

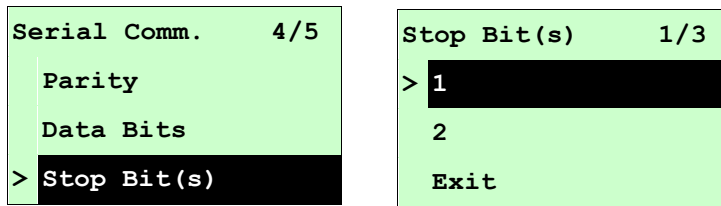

3.1.3.4 Stop Bit(s):



This option is used to set the RS-232 Stop Bits. The default setting is “1” stop bit. Press **UP**  and **DOWN**  buttons to select the different Stop Bits and press **SELECT** button to set the value into printer. When you enter this list, the option in the right side of “>” icon is the printer current setting. Press  **MENU** key to cancel the setting and return to the previous menu.

3.1.4 Ethernet

Use this menu to configure internal Ethernet configuration check the printer's Ethernet module status, and reset the Ethernet module. This function is available on the LCD display when Ethernet card is installed.

Press **UP**  and **DOWN**  buttons to select the different options and press **SELECT** button to enter the option. Press  **MENU** key to cancel the setting and return to the previous menu.

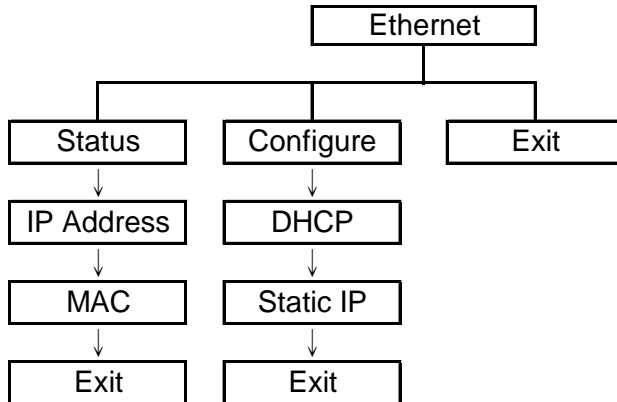

Note:

This function is available for TTP-2410M Pro series only and option for TTP-246M Pro series.

3.1.4.1 Status: (IP Address / MAC)

Use this menu to check the Ethernet setting status.

3.1.4.1.1 IP Address

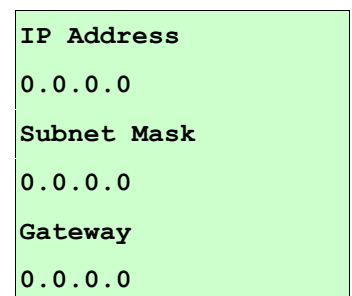
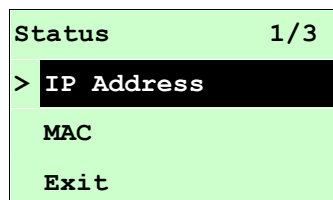
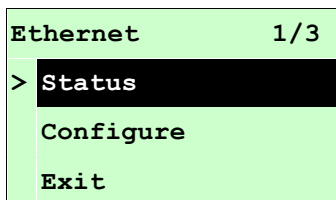

The IP address information will be shown on the LCD display. Please press **SELECT** or  **MENU** button to return to the previous menu.

3.1.4.1.2 MAC

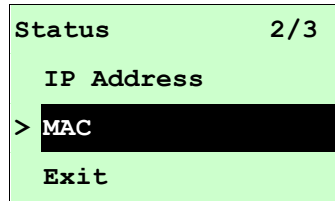
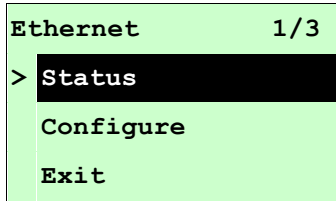

The MAC address information will be shown on the LCD display. Please press **SELECT** or **MENU** button to return to the previous menu.

3.1.4.2 Configure: (DHCP / Static IP)

Use this menu to set the printer's DHCP and Static IP.

3.1.4.2.1 DHCP

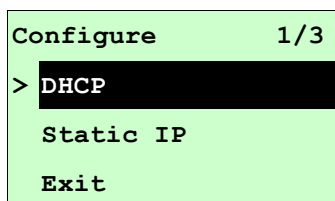
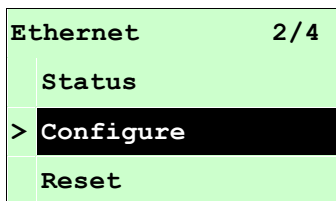

Press **UP** and **DOWN** buttons to select the DHCP function and press **SELECT** to enter. Press **MENU** key to cancel the setting and return to the previous menu.

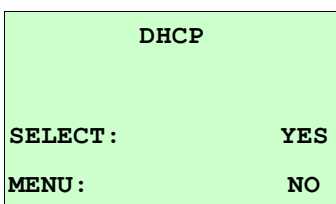

Press **SELECT** button the printer will set DHCP and restart to reset the setting. Press **MENU** button to return to the previous menu.

3.1.4.2.2 Static IP

Use this menu to set the printer's IP address, subnet mask and gateway.

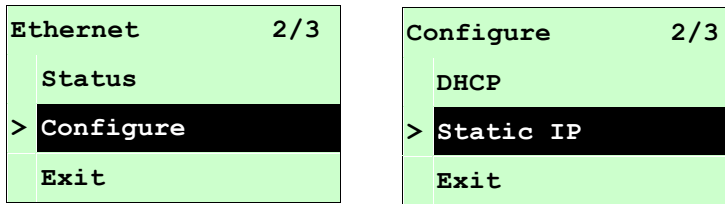

Press **UP** and **DOWN** buttons to select the different options and press **SELECT** button to enter the option. Press **MENU** key to cancel the setting and return to the previous menu.

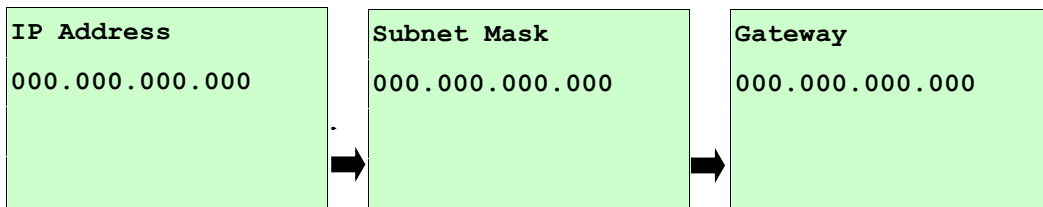

Press **DOWN** button to move the cursor from left to right digits and press the **UP** button to scroll the value from "0" to "9". Press **SELECT** button to next setting.

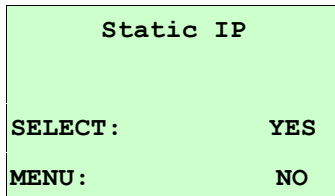

Press the **SELECT** button printer will restart to reset the Ethernet module setting. Press **MENU** key to cancel the setting.

3.2 File Manager

This feature is used to check the printer available memory and file list.

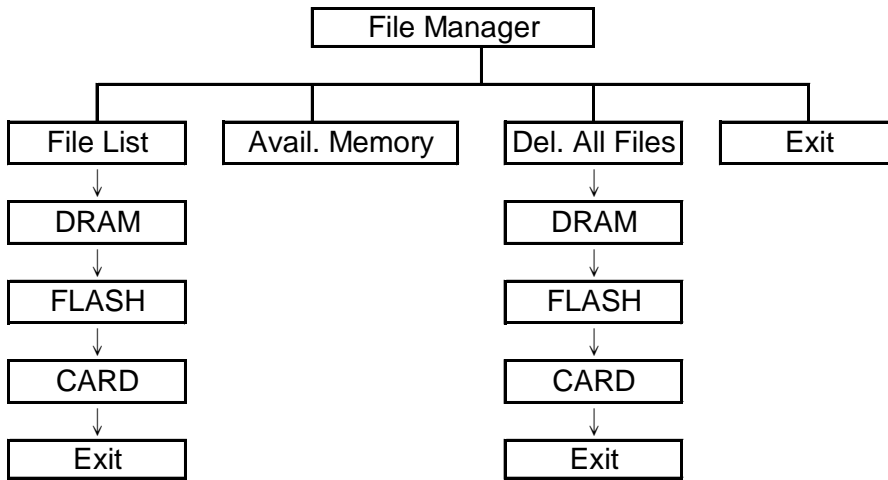

3.2.1 File List

Use this menu to show, delete and run (.BAS) the files saved in the printer DRAM/Flash/Card memory.

To show the files :

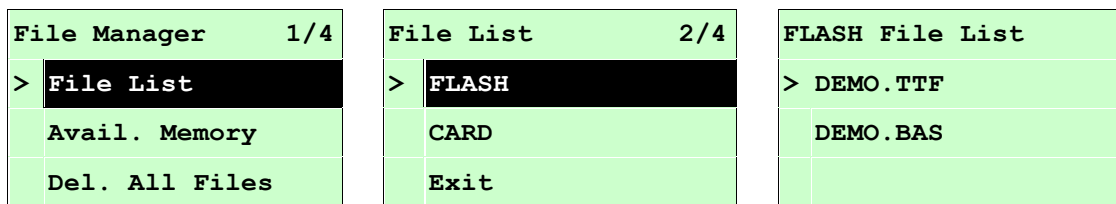

To delete the file : Please follow the order to press the **DOWN** Ⓞ button.

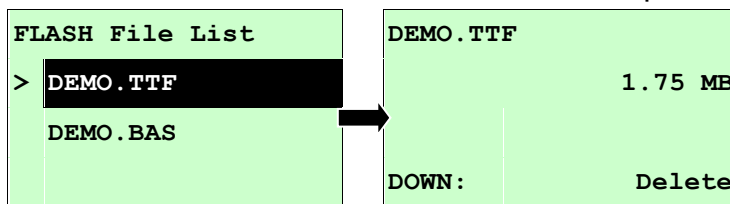

To run the file (.BAS) : Please follow the order to press the **SELECT** button.

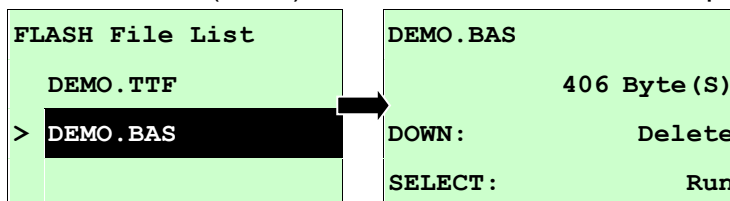

3.2.2 Avail. Memory

Use this menu to show available memory space.

File Manager		2/4
	File List	
>	Avail. Memory	
	Del. All Files	

Avail. Memory	
DRAM:	256 KB
FALSH:	6656 KB
CARD:	0 KB

3.2.3 Del. All Files

Use this menu to delete all files. Press **SELECT** button to delete all files in the device.

Press **MENU** to cancel deleting files and go back to previous menu.

File Manager		3/4
	File List	
	Avail. Memory	
>	Del. All File	

File List		1/4
>	DRAM	
	FALSH	
	CARD	

Del. All Files	
SELECT:	YES
MENU:	NO

3.3 Diagnostics

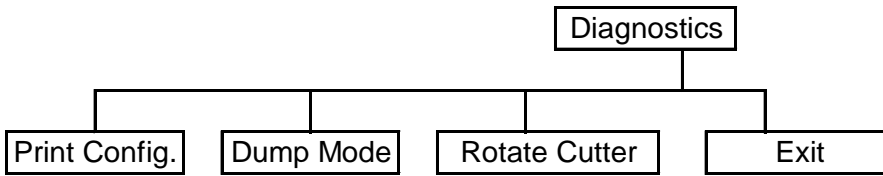

3.3.1 Print Config.

This feature is used to print current printer configuration to the label. On the sconfiguration printout, there is a print head test pattern, which is useful for checking if there is any dot damage on the print head heater element.

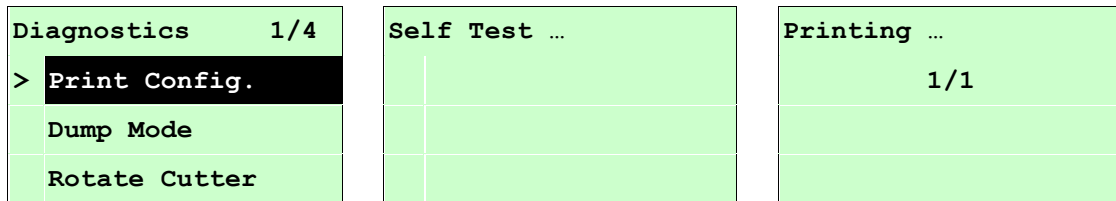

Self-test printout	
<pre> PRINTER INFO. XXXXX Version: X.XX EZ SERIAL NO.: XXXXXXXXXX MILAGE(m): 25 CHECKSUM: 07B575A3 SERIAL PORT: 9600,N,8,1 CODE PAGE: 850 COUNTRY CODE: 001 SPEED: 3 INCH DENSITY: 8.0 SIZE: 4.00 , 2.90 BLINE: 0.12 , 0.00 TRANSPARENCE: 2 HOST NAME: PS-600002 MAC ADDRESS: 00-1B-82-60-00-02 DHCP ENABLED: YES IP ADDRESS: 0.0.0.0 SUBNET MASK: 0.0.0.0 DEFAULT GATEWAY: 0.0.0.0 ***** FILE LIST: DRAM FILE: 0 FILE(S) FLASH FILE: 0 FILE(S) PHYSICAL DRAM: XXXX KBYTES AVAILABLE DRAM: XXX KBYTES FREE PHYSICAL FLASH: XXXX KBYTES AVAILABLE FLASH: XXXX KBYTES FREE END OF FILE LIST ***** </pre>	<p>Printer model name & Main board firmware version</p> <p>Printer serial number</p> <p>Printed mileage</p> <p>Main board firmware checksum</p> <p>Serial port setting</p> <p>Code page</p> <p>Country code</p> <p>Print speed</p> <p>Print darkness</p> <p>Label size (width, height)</p> <p>Black mark or gap size (vertical gap, offset)</p> <p>Sensor sensitivity</p> <p>Ethernet settings information (option)</p> <p>File management information</p> <p>Print head test pattern</p>

Self-test printout (with printer firmware V7.0 and later version)

```

-----
SYSTEM INFORMATION
-----
MODEL: XXXXXX
FIRMWARE: X.XX
CHECKSUM: XXXXXXXX
S/N: XXXXXXXXXXXX
TCF: NO
DATE: 1970/01/01
TIME: 00:04:18
NON-RESET: 110 m (TPH)
RESET: 110 m (TPH)
NON-RESET: 0 (CUT)
RESET: 0 (CUT)
-----

```

Model name
 F/W version
 Firmware checksum
 Printer S/N
 TSC configuration file
 System date
 System time
 Printed mileage (meter)
 Cutting counter

```

-----
PRINTING SETTING
-----
SPEED: 5 IPS
DENSITY: 8.0
WIDTH: 4.00 INCH
HEIGHT: 4.00 INCH
GAP: 0.00 INCH
INTENSION: 5
CODEPAGE: 850
COUNTRY: 001
-----

```

Print speed (inch/sec)
 Print darkness
 Label size (inch)
 Gap distance (inch)
 Gap/black mark sensor intension
 Code page
 Country code

```

-----
Z SETTING
-----
DARKNESS: 16.0
SPEED: 4 IPS
WIDTH: 4.00 INCH
TILDE: 7EH (~)
CARET: 5EH (^)
DELIMITER: 2CH (,)
POWER UP: NO MOTION
HEAD CLOSE: NO MOTION
-----

```

ZPL setting information
 Print darkness
 Print speed (inch/sec)
 Label size
 Control prefix
 Format prefix
 Delimiter prefix
 Printer power up motion
 Printer head close motion

Note:
 ZPL is emulating for Zebra®
 language.

```

-----
RS232 SETTING
-----
BAUD: 9600
PARITY: NONE
DATA BIT: 8
STOP BIT: 1
-----

```

RS232 serial port
 configuration

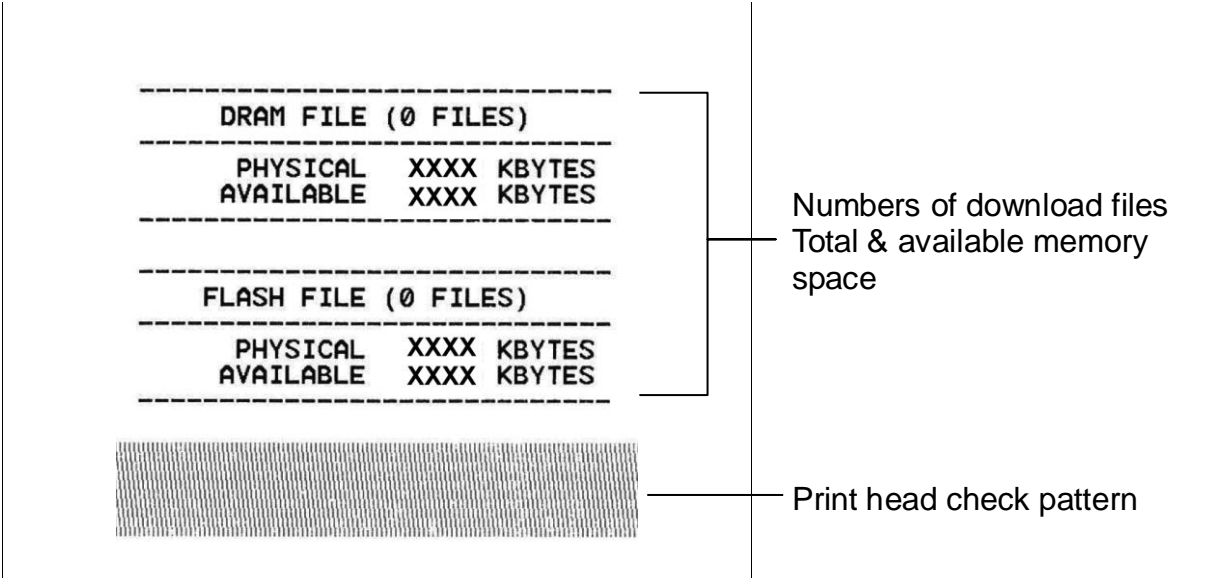

3.3.2 Dump Mode

Captures the data from the communications port and prints out the data received by printer. In the dump mode, all characters will be printed in 2 columns as following. The left side characters are received from your system and right side data are the corresponding hexadecimal value of the characters. It allows users or engineers to verify and debug the program.

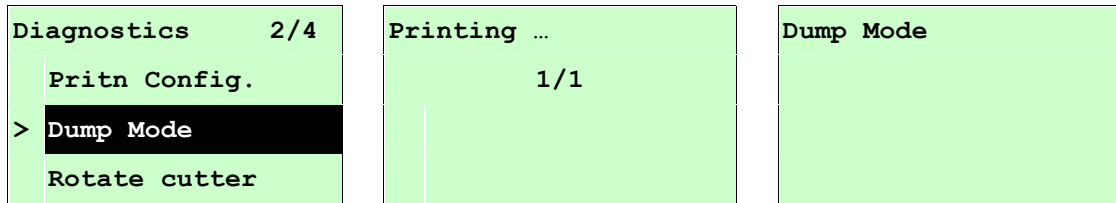

Note:

- 1. Dump mode requires 4" wide paper width.**
- 2. Turn off / on the power to resume printer for normal printing.**
- 3. Press FEED button to back to the previous menu.**

```
DOWNLOA 0D 0A 44 4F 57 4E 4C 4F 4I
D „TEST2. 44 20 22 54 45 53 54 32 2E
DAT“,5,CL 44 41 54 22 2C 35 2C 43 4C
S DOWNLO 53 0D 0A 44 4F 57 4E 4C 4F
AD F,„TES 41 44 20 46 2C 22 54 45 53
T4.DAT“,5 54 34 2E 44 41 54 22 2C 35
,CLS DOW 2C 43 4C 53 0D 0A 44 4F 57
NLOAD „TE 4E 4C 4F 41 44 20 22 54 45
ST2.DAT“, 53 54 32 2E 44 41 54 22 2C
5,CLS DO 35 2C 43 4C 53 0D 0A 44 4F
WNLOAD F, 57 4E 4C 4F 41 44 20 46 2C
„TEST4.DA 22 54 45 53 54 34 2E 44 41
T“,5,CLS 54 22 2C 35 2C 43 4C 53 0D
DOWNLOAD 0A 44 4F 57 4E 4C 4F 41 44
„TEST2.D 20 22 54 45 53 54 32 2E 44
AT“,5,CLS 41 54 22 2C 35 2C 43 4C 53
DOWNLOA 0D 0A 44 4F 57 4E 4C 4F 4I
D F,„TEST 44 20 46 2C 22 54 45 53 54
4.DAT“,5, 34 2E 44 41 54 22 2C 35 2C
CLS 43 4C 53 0D 0A
```

ASCII Data

Hexadecimal data related to left column of ASCII data

3.3.3 Rotate Cutter

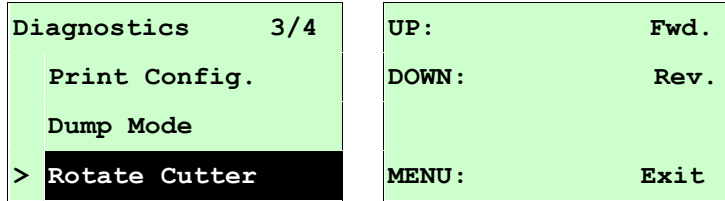

In case paper is jammed in the cutter, this feature can rotate the cutter blade forward or reverse direction, which is helpful to remove the jammed paper easily from the cutter.

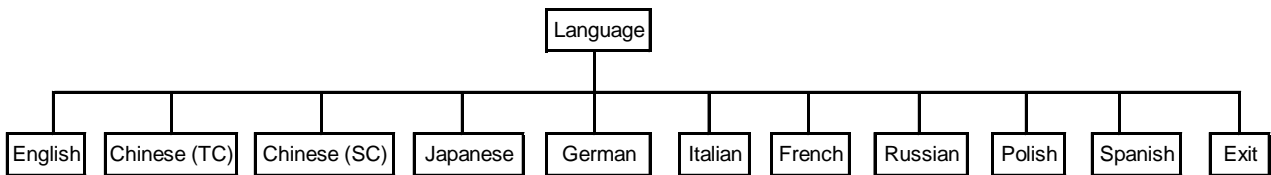

3.4 Language



This option is used to setup the language on LCD display.

Press **UP**  and **DOWN**  buttons to scroll the cursor to desire language and press **SELECT** button to select this option. Press  **MENU** key to cancel the setting and return to the previous menu. The default language setting is English.

3.5 Service

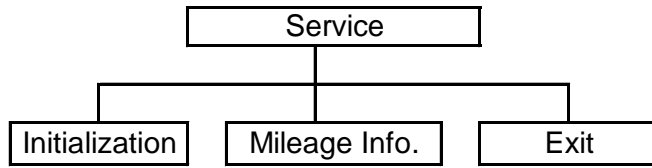

This feature is used to restore printer settings to defaults and display printer mileage information.

3.5.1 Initialization

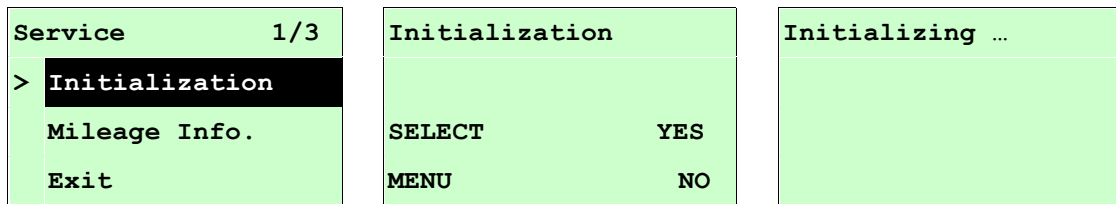

The printer settings are restored to defaults as below once printer is initialized.

Note :

When printer initialization is done, please calibrate the gap or black mark sensor before printing.

Parameter	Default setting
Speed	TTP-2410M Pro : 6 IPS (152 mm/sec) TTP-346M Pro/246M Pro/344M Pro : 4 IPS (101.6 mm/sec) TTP-644M Pro : 3 IPS (76.2 mm/sec)
Density	8
Label width	4.00”(101.6mm)
Label height	4.00”(101.6mm)
Sensor type	Gap sensor
Gap setting	0.12”(3.0mm)
Print direction	0
Reference point	0,0(upper left corner)
Offset	0
Print mode	Batch mode
Serial port settings	9600 bps, none parity, 8 data bits, 1 stop bit
Code page	850
Country code	001
Clear flash memory	No
Shift X	0
Shift Y	0

Gap sensor sensitivity	3 (Will be reset. Need to re-calibrate the gap)
Blind sensor sensitivity	2 (Will be reset. Need to re-calibrate the gap)
Language	English
IP address	DHCP

3.5.2 Mileage Info.

Use this option to check the printed mileage (displayed in meter).

Service 1/3	Mileage: (m)
Initialization	4016
> Mileage Info.	Labels: (pcs.)
Exit	51698

4. Diagnostic Tool

The Diagnostic Utility is a toolbox that allows users to explore the printer's settings and status; change printer settings; download graphics, fonts, and firmware; create printer bitmap fonts; and to send additional commands to the printer. Using this convenient tool, you can explore the printer status and settings and troubleshoot the printer.

Note: This utility works with printer firmware V6.00 and later versions.

4.1 Start the Diagnostic Tool

1. Double click on the Diagnostic tool icon  `DiagTool.exe` to start the software.
2. There are four features (Printer Configuration, File Manager, Bitmap Font Manager, Command Tool) included in the Diagnostic utility.

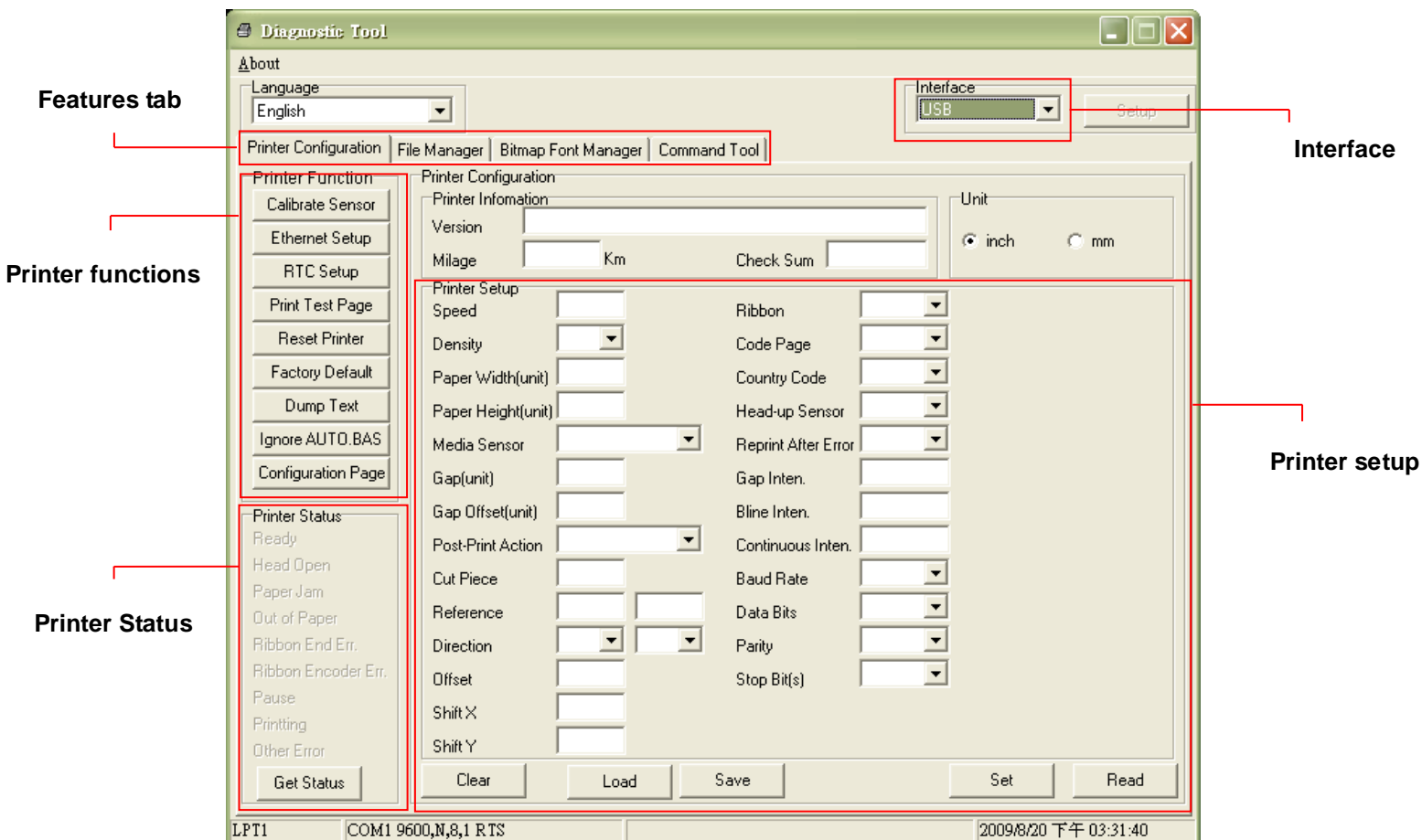

4.2 Printer Function (Calibrate sensor, Ethernet setup, RTC setup.....)

1. Select the PC interface connected with bar code printer.
2. Click the “Function” button to setting.
3. The detail functions in the Printer Function Group are listed as below.

	Function	Description
Printer Function		
Calibrate Sensor	Calibrate Sensor	Calibrate the sensor specified in the Printer Setup group media sensor field
Ethernet Setup	Ethernet Setup	Setup the IP address, subnet mask, gateway for the on board Ethernet (Please refer to next section)
RTC Setup	RTC Time	Synchronize printer Real Time Clock with PC
Print Test Page	Print Test Page	Print a test page
Reset Printer	Reset Printer	Reboot printer
Factory Default	Factory Default	Initialize the printer and restore the settings to factory default.
Dump Text	Dump Text	To activate the printer dump mode.
Ignore AUTO.BAS	Ignore AUTO.BAS	Ignore the downloaded AUTO.BAS program
Configuration Page	Configuration Page	Print printer configuration

Note:

For more information about Diagnostic Tool, please refer to the diagnostic utility quick start guide in the CD disk \ Utilities directory.

5 Setting Ethernet by Diagnostic Utility (Optional for TTP-246M Pro/TTP-344M Pro models)

The Diagnostic Utility is enclosed in the CD disk \Utilities directory. Users can use Diagnostic Tool to setup the Ethernet by RS-232, USB and Ethernet interfaces. The following contents will instruct users how to configure the Ethernet by these three interfaces.

5.1 Using USB interface to setup Ethernet interface

1. Connect the USB cable between the computer and the printer.
2. Turn on the printer power.
3. Start the Diagnostic Utility by double clicking on the  `DiagTool.exe` icon.
Note: This utility works with printer firmware V6.00 and later versions.
4. The Diagnostic Utility default interface setting is USB interface. If USB interface is connected with printer, no other settings need to be changed in the interface field.

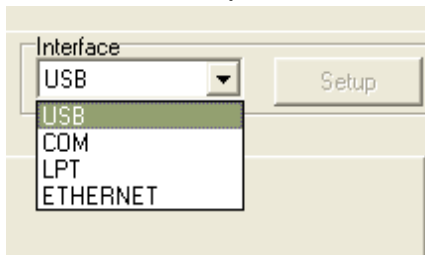

5. Click on the “Ethernet Setup” button from “Printer Function” group in Printer Configuration tab to setup the IP address, subnet mask and gateway for the on board Ethernet.

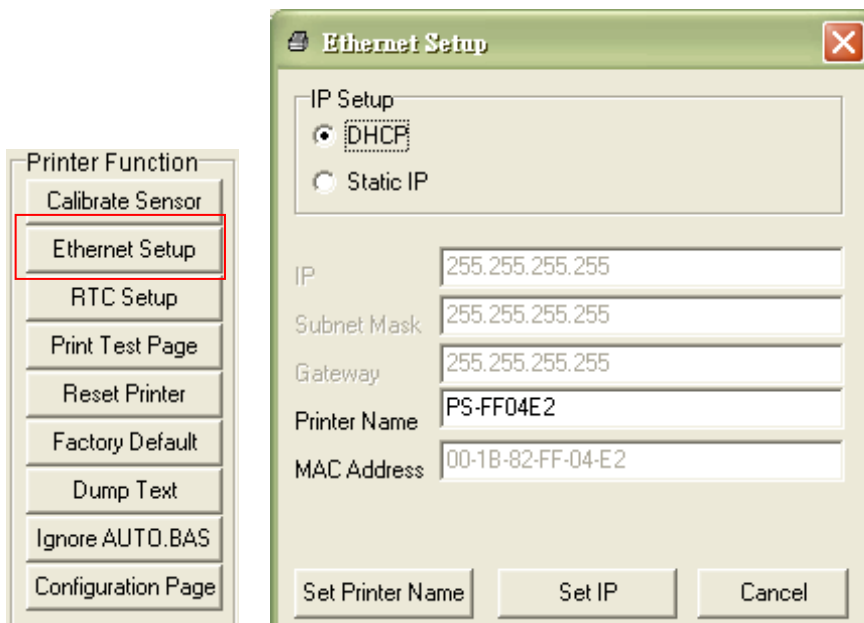

5.2 Using RS-232 interface to setup Ethernet interface

1. Connect the computer and the printer with a RS-232 cable.
2. Turn on the printer power.
3. Start the Diagnostic Utility by double clicks on the  `DiagTool.exe` icon.
Note: This utility works with printer firmware V6.00 and later versions.
4. Select “COM” as interface then click on the “Setup” button to setup the serial port baud rate, parity check, data bits, stop bit and flow control parameters.

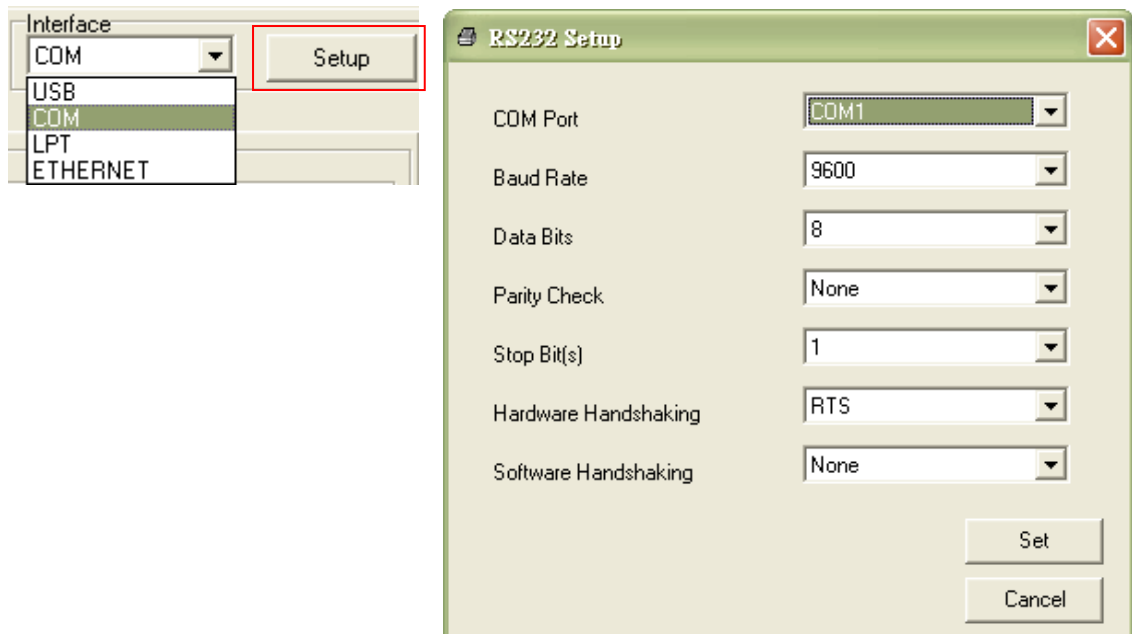

5. Click on the “Ethernet Setup” button from printer function of Printer Configuration tab to setup the IP address, subnet mask and the gateway for the on board Ethernet.

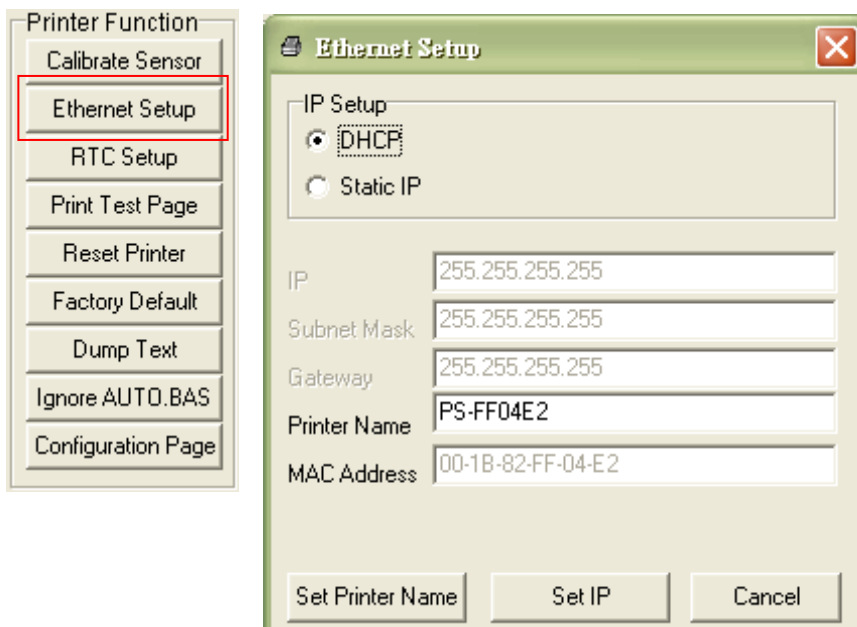

5.3 Using Ethernet interface to setup Ethernet interface

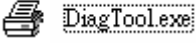
1. Connect the computer and the printer to the LAN.
2. Turn on the printer power.
3. Start the Diagnostic Utility by double clicks on the  icon.
Note: This utility works with printer firmware V6.00 and later versions.
4. Select “Ethernet” as the interface then click on the “Setup” button to setup the IP address, subnet mask and gateway for the on board Ethernet.

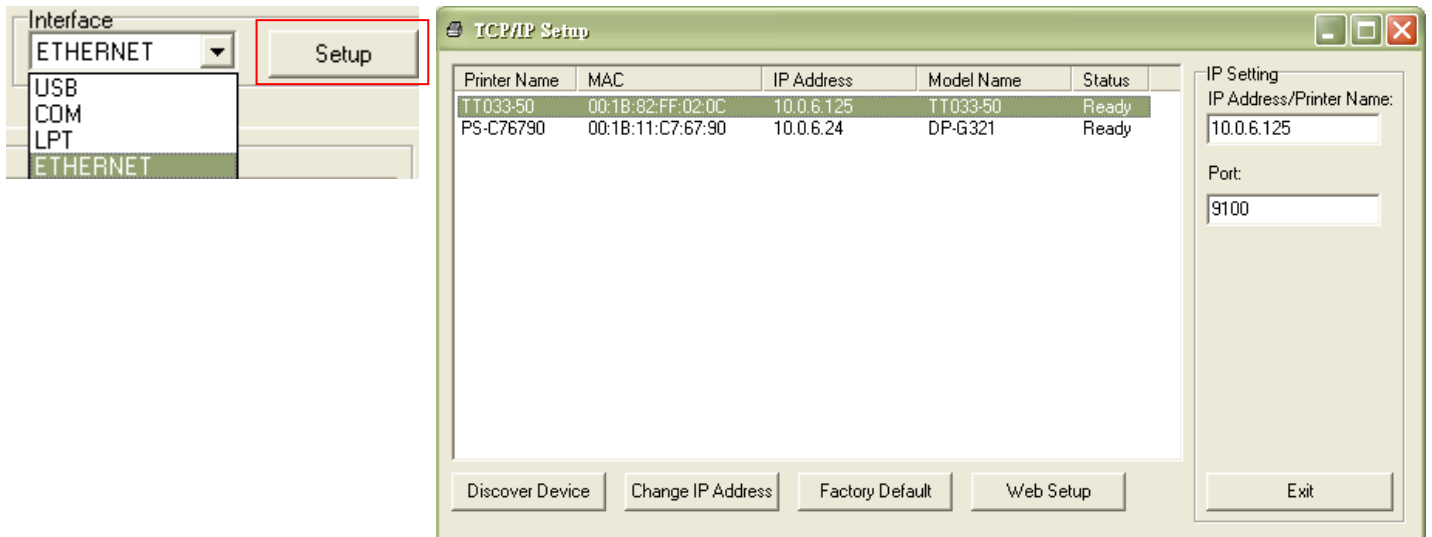

5. Click the “Discover Device” button to explore the printers that exist on the network.
6. Select the printer in the left side of listed printers, the correspondent IP address will be shown in the right side “IP address/Printer Name” field.
7. Click “Change IP Address” to configure the IP address obtained by DHCP or static.

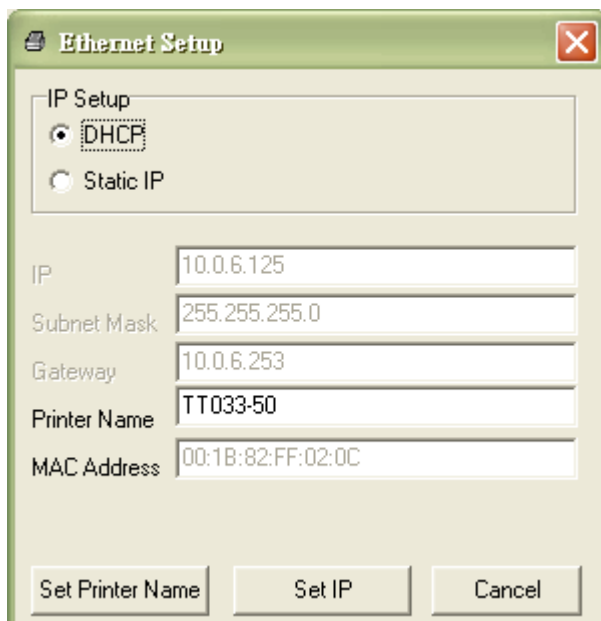

The default IP address is obtained by DHCP. To change the setting to static IP address, click “Static IP” radio button then enter the IP address, subnet mask and

gateway. Click “Set IP” to take effect the settings.

Users can also change the “Printer Name” by another model name in this fields then click “Set Printer Name” to take effect this change.

Note: After clicking the “Set Printer Name” or “Set IP” button, printer will reset to take effect the settings.

8. Click “Exit” button to exit the Ethernet interface setup and go back to Diagnostic Tool main screen.

Factory Default button

This function will reset the IP, subnet mask, gateway parameters obtained by DHCP and reset the printer name.

Web setup button

Except to use the Diagnostic Utility to setup the printer, you can also explore and configure the printer settings and status or update the firmware with the IE or Firefox web browser. This feature provides a user friendly setup interface and the capability to manage the printer remotely over a network.

6. Troubleshooting

6.1 Common Problems

The following guide lists the most common problems that may be encountered when operating this bar code printer. If the printer still does not function after all suggested solutions have been invoked, please contact the Customer Service Department of your purchased reseller or distributor for assistance.

Problem	Possible Cause	Recovery Procedure
Power indicator does not illuminate	<ul style="list-style-type: none"> * The power cord is not properly connected. 	<ul style="list-style-type: none"> * Plug the power cord in printer and outlet. * Switch the printer on.
Carriage Open	<ul style="list-style-type: none"> * The printer carriage is open. 	<ul style="list-style-type: none"> * Please close the print carriage.
No Ribbon	<ul style="list-style-type: none"> * Running out of ribbon. * The ribbon is installed incorrectly. 	<ul style="list-style-type: none"> * Supply a new ribbon roll. * Please refer to the steps in user's manual to reinstall the ribbon.
No Paper	<ul style="list-style-type: none"> * Running out of label. * The label is installed incorrectly. * Gap/black mark sensor is not calibrated. 	<ul style="list-style-type: none"> * Supply a new label roll. * Please refer to the steps in user's manual to reinstall the label roll. * Calibrate the gap/black mark sensor.
Paper Jam	<ul style="list-style-type: none"> * Gap/black mark sensor is not set properly. * Make sure label size is set properly. * Labels may be stuck inside the printer mechanism. 	<ul style="list-style-type: none"> * Calibrate the gap/black mark sensor. * Set label size correctly.
Take Label	<ul style="list-style-type: none"> * Peel function is enabled. 	<ul style="list-style-type: none"> * If the peeler module is installed, please remove the label. * If there is no peeler module in front of the printer, please switch off the printer and install it. * Check if the connector is plugging correctly.
UP: Fwd. DOWN: Rev. MENU: Exit	<ul style="list-style-type: none"> * Cutter jam. * There is no cutter installed on the printer. * Cutter PCB is damaged. 	<ul style="list-style-type: none"> * If the cutter module is installed, please press UP or DOWN key to rotate the cutter up or down to make the knife back to the right position. * Remove the label. * Make sure the thickness of label is less than 200 g/m2 (for regular cutter) or 300 g/m2 (for heavy duty cutter). * Replace a cutter PCB.

<p>Not Printing</p>	<ul style="list-style-type: none"> * Cable is not well connected to serial or USB interface or parallel port. * The serial port cable pin configuration is not pin to pin connected. 	<ul style="list-style-type: none"> * Re-connect cable to interface. * If using serial cable, <ul style="list-style-type: none"> - Please replace the cable with pin to pin connected. - Check the baud rate setting. The default baud rate setting of printer is 9600,n,8,1. * If using the Ethernet cable, <ul style="list-style-type: none"> - Check if the Ethernet RJ-45 connector green LED is lit on.. - Check if the Ethernet RJ-45 connector amber LED is blinking. - Check if the printer gets the IP address when using DHCP mode. - Check if the IP address is correct when using the static IP address. - Wait a few seconds let the printer get the communication with the server then check the IP address setting again. * Chang a new cable. * Ribbon and media are not compatible. * Verify the ribbon-inked side. * Reload the ribbon again. * Clean the printhead. * The print density setting is incorrect. * Printhead's harness connector is not well connected with printhead. Turn off the printer and plug the connector again. * Check if the stepping motor is plugging in the right connector. * Check your program if there is a command PRINT at the end of the file and there must have CRLF at the end of each command line.
<p>Memory full (FLASH / DRAM)</p>	<ul style="list-style-type: none"> * The space of FLASH/DRAM is full. 	<ul style="list-style-type: none"> * Delete unused files in the FLASH/DRAM. * The max. numbers of file of DRAM is 256 files. * The max. user addressable memory space of DRAM is 256 KB for TTP-246M Pro/TTP-344M Pro and 2048KB for TTP-2410M Pro/TTP-346M Pro. * The max. numbers of file of FLASH is 256 files. * The max. user addressable memory space of FLASH is 2560 KB for TTP-246M Pro/TTP-344M Pro and 6656 KB for TTP-2410M Pro/TTP-346M Pro.
<p>SD card is unable to use</p>	<ul style="list-style-type: none"> * SD card is damaged. * SD card doesn't insert correctly. * Use the non-approved SD card manufacturer. 	<ul style="list-style-type: none"> * Use the supported capacity SD card. * Insert the SD card again. * The supported SD card spec and the approved SD card manufacturers, please refer to section 2.2.3.
<p>PS/2 port does not work</p>	<ul style="list-style-type: none"> * Did not turn off power prior to plug in the PS/2 keyboard. * PS/2 keyboard is damaged. * PS/2 keyboard doesn't plug-in correctly. * There is no BAS file in the printer. 	<ul style="list-style-type: none"> * Turn off printer power prior to plug in the PS/2 keyboard. * Plug the PS/2 keyboard again. * Make sure the keyboard is fine. * Make sure if there is any BAS file downloaded into printer.

<p>Poor Print Quality</p>	<ul style="list-style-type: none"> * Ribbon and media is loaded incorrectly * Dust or adhesive accumulation on the print head. * Print density is not set properly. * Printhead element is damaged. * Ribbon and media are incompatible. * The printhead pressure is not set properly. 	<ul style="list-style-type: none"> * Reload the supply. * Clean the printhead. * Clean the platen roller. * Adjust the print density and print speed. * Run printer self-test and check the print head test pattern if there is dot missing in the pattern. * Change proper ribbon or proper label media. * Adjust the printhead pressure adjustment knob. <ul style="list-style-type: none"> - If the left side printout is too light, please adjust the left side pressure adjustment knob to the higher index (higher pressure). If the pressure adjustment knob has been adjust to index "5" and the poor print quality is still at the left side of the printout, please adjust the pressure adjustment knob to index "1" and use the Z-axis adjustment knob to fine tune the pressure. - If the right side printout is too light, please adjust the right side pressure adjustment knob to the higher index (higher pressure) to improve the print quality. * If the label thickness is more than 0.22 mm, the print quality might be not good enough, please adjust the heater line adjustment screw counter clockwise to get the best print quality. * The release lever does not latch the printhead properly.
<p>LCD panel is dark but the LEDs are light</p>	<ul style="list-style-type: none"> * The printer initialization is unsuccessful. 	<ul style="list-style-type: none"> * Turn OFF and ON the printer again. * Initialize the printer.
<p>LCD panel is dark and LEDs are lit on, but the label is feeding forward</p>	<ul style="list-style-type: none"> * The LCD panel harness connector is loose. 	<ul style="list-style-type: none"> * The LCD panel harness connector is plugged upside down.
<p>Ribbon end sensor doesn't work</p>	<ul style="list-style-type: none"> * The ribbon sensor hole is covered with dust. 	<ul style="list-style-type: none"> * Clear the dust in the sensor hole by the blower.
<p>Peel sensor is not working</p>	<ul style="list-style-type: none"> * Peel sensor is not located on the correct position. * The connector is loose. 	<ul style="list-style-type: none"> * Make sure that the media goes through the Peel sensor. * Plug the connect cable correctly.
<p>Cutter is not working</p>	<ul style="list-style-type: none"> * The connector is loose. 	<ul style="list-style-type: none"> * Plug in the connect cable correctly.
<p>Label feeding is not stable (skew) when printing</p>	<ul style="list-style-type: none"> * The media guide does not touch the edge of the media. 	<ul style="list-style-type: none"> * If the label is moving to the right side, please move the label guide to left. * If the label is moving to the left side, please move the label guide to right.
<p>Skip labels when printing</p>	<ul style="list-style-type: none"> * Label size is not specified properly. * Sensor sensitivity is not set properly. * The media sensor is covered with dust. 	<ul style="list-style-type: none"> * Check if label size is setup correctly. * Calibrate the sensor by Auto Gap or Manual Gap options. * Clear the GAP/Black mark sensor by blower.

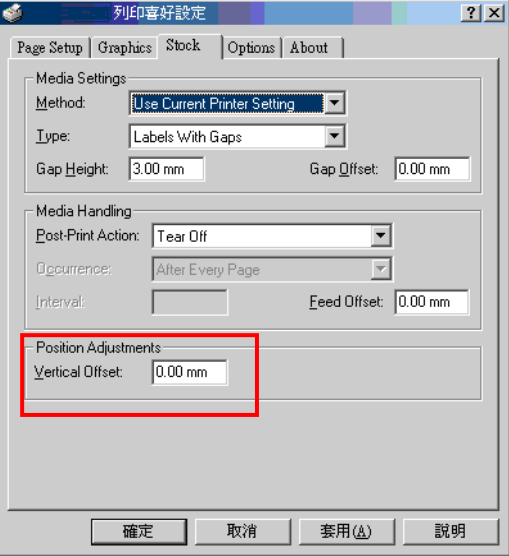
<p>The printing position of small label is incorrect</p>	<ul style="list-style-type: none"> * Media sensor sensitivity is not set properly. * Label size is incorrect. * The parameter Shift Y in the LCD menu is incorrect. * The vertical offset setting in the driver is incorrect. 	<ul style="list-style-type: none"> * Calibrate the sensor sensitivity again. * Set the correct label size and gap size. * Press [MENU] → [SELECT] x3 → [DOWN]x6 → [SELECT] to fine tune the parameter of Shift Y. * If using the software BarTender, please set the vertical offset in the driver. 
<p>The left side printout position is incorrect</p>	<ul style="list-style-type: none"> * Wrong label size setup. * The parameter Shift X in LCD menu is incorrect. 	<ul style="list-style-type: none"> * Set the correct label size. * Press [MENU] → [SELECT] x 3 → [DOWN] x 5 → [SELECT] to fine tune the parameter of Shift X.
<p>Missing printing on the left or right side of label</p>	<ul style="list-style-type: none"> * Wrong label size setup. 	<ul style="list-style-type: none"> * Set the correct label size.
<p>RTC time is incorrect when reboot the printer</p>	<ul style="list-style-type: none"> * The battery has run down. 	<ul style="list-style-type: none"> * Check if there is a battery on the main board.
<p>Multi interface board doesn't work</p>	<ul style="list-style-type: none"> * The installation is incorrect. 	<ul style="list-style-type: none"> * Check if the board is plugged in the right connector.
<p>Power and Error LEDs are blinking fast</p>	<ul style="list-style-type: none"> * Power switch OFF and ON too fast. 	<ul style="list-style-type: none"> * Turn off the printer and wait all LEDs are dark, and turn on the printer again.
<p>Wrinkle Problem</p>	<ul style="list-style-type: none"> * Printhead pressure is incorrect. * Ribbon installation is incorrect. * Media installation is incorrect. * Print density is incorrect. * Media feeding is incorrect. 	<ul style="list-style-type: none"> * Please refer to the next chapter. * Please set the suitable density to have good print quality. * Make sure the label guide touch the edge of the media guide.
<p>Gray line on the blank label</p>	<ul style="list-style-type: none"> * The printhead is dirty. * The platen roller is dirty. 	<ul style="list-style-type: none"> * Clean the printhead. * Clean the platen roller.
<p>Irregular printing</p>	<ul style="list-style-type: none"> * The printer is in Hex Dump mode. * The RS-232 setting is incorrect. 	<ul style="list-style-type: none"> * Turn off and on the printer to skip the dump mode. * Re-set the Rs-232 setting.

6.2 Mechanism Fine Adjustment to Avoid Ribbon Wrinkles

This printer has been fully tested before delivery. There should be no ribbon wrinkle presented on the media for general-purpose printing application. Ribbon wrinkle is related to the media thickness, print head pressure balance, ribbon film characteristics, print darkness setting...etc. In case the ribbon wrinkle happens, please follow the instructions below to adjust the printer parts.

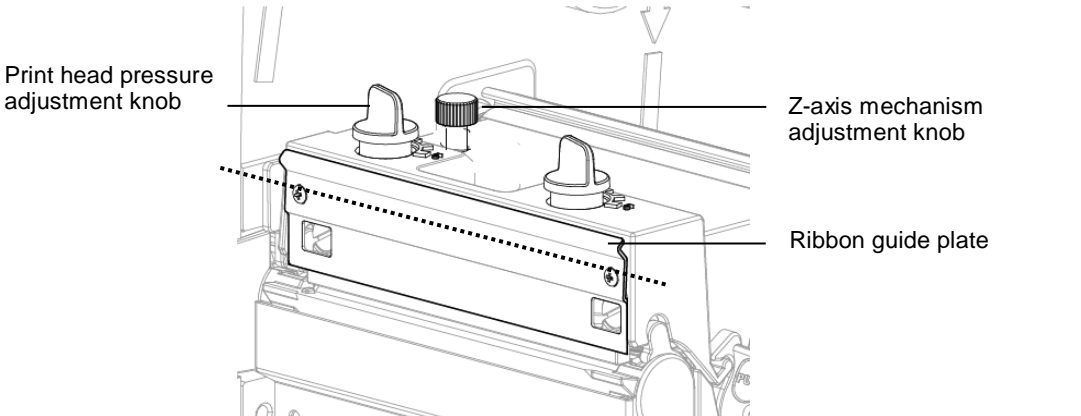
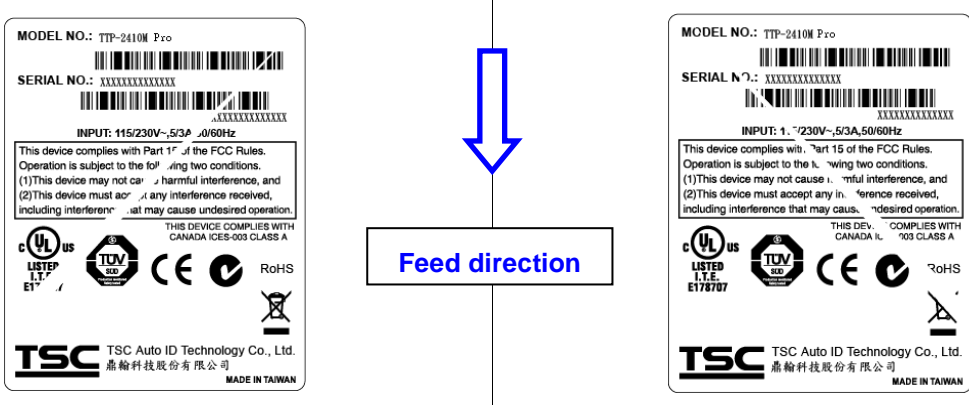
<p>Adjustable Printer Parts</p>		
<p>Symptom</p>	<p>1. Wrinkle happens from label lower left to upper right direction (“ / ”)</p>	<p>2. Wrinkle happens from label lower right to upper left direction (“ \ ”)</p>
<p>Wrinkle Example</p>		

Adjust the print head pressure adjustment knob

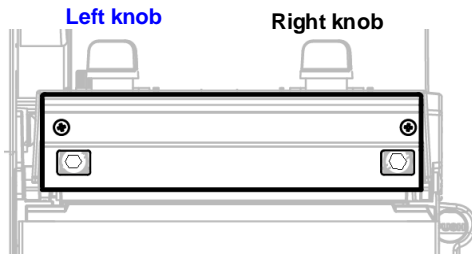

The print head pressure adjustment knob has 5 levels of settings. Clockwise direction adjustment is to increase the print head pressure. Counter Clockwise adjustment can decrease the print head pressure.

If the wrinkle on the label starts from the lower left side to upper right side, please do following adjustment.

1. Decrease the right side print head pressure adjustment knob setting 1 level per each adjustment then print the label again to check if wrinkle is gone.
2. If the right side print head adjustment knob setting has been set to index 1 (the lowest pressure index), please increase the left side print head pressure.
3. If the left side print head adjustment knob setting has been set to 5 (the highest pressure index) the wrinkle can't be avoid, please rotate the both knobs back to setting 1 then rotate the Z-axis mechanism adjustment knob clockwise for a few degrees and print again for fine tune the print head pressure distribution.

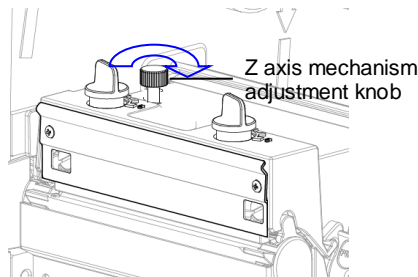

Note for step 3:

- *Factory default setting, the Z-axis knob is rotated counter clockwise to the end of thread.
- *Turn the Z-axis mechanism adjustment knob clockwise until you feel the knob touch the mechanism for the first adjustment.
- * If the wrinkle is still there, please turn the Z-axis mechanism adjustment knob clockwise about 1/4 circle each time for adjustment
- * If the wrinkled direction is change from “ ` ” to “ ` ” by adjusting the Z-axis mechanism adjustment knob, please turn the Z axis mechanism adjustment knob counter clockwise to avoid the wrinkle.

Adjust the print head pressure adjustment knob

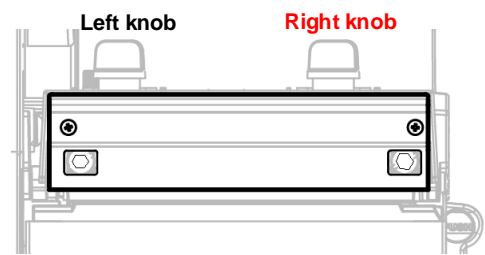

The print head pressure adjustment knob has 5 levels of settings. Clockwise direction adjustment is to increase the print head pressure. Counter Clockwise adjustment can decrease the print head pressure.

If the wrinkle on the label starts from the lower right side to upper left side, please do following adjustment.

1. Decrease the left side print head pressure adjustment knob setting 1 level per each adjustment then print the label again to check if wrinkle is gone.
2. If the left side print head adjustment knob level has been set to index 1 (the lowest index), please increase the right side print head pressure.

7. Maintenance

This session presents the clean tools and methods to maintain your printer.

2. Please use one of following material to clean the printer.

- Cotton swab (Head cleaner pen)
- Lint-free cloth
- Vacuum / Blower brush
- 100% ethanol

2. The cleaning process is described as following

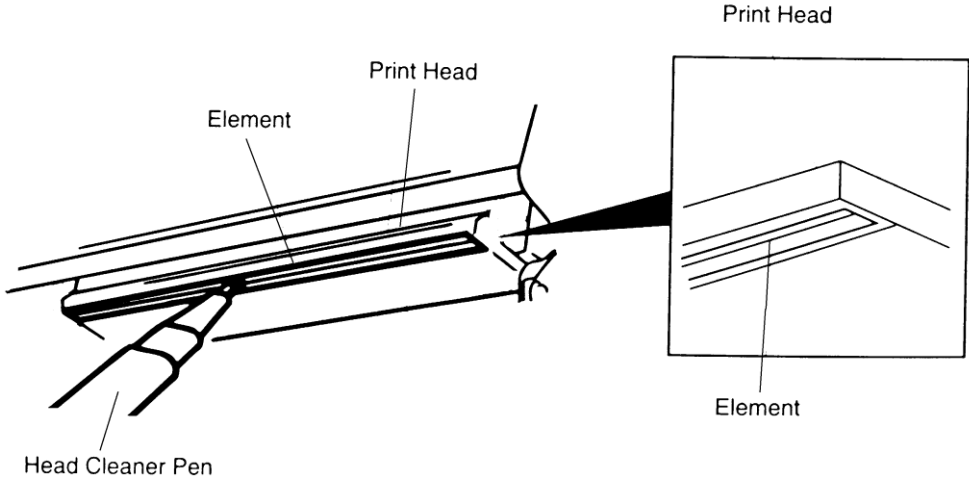
Printer Part	Method	Interval
<p>Print Head</p>	<p>1. Always turn off the printer before cleaning the print head. 2. Allow the print head to cool for a minimum of one minute. 3. Use a cotton swab (Head cleaner pen) and 100% ethanol to clean the print head surface.</p>	<p>Clean the print head when changing a new label roll</p>
		
<p>Platen Roller</p>	<p>1. Turn the power off. 2. Rotate the platen roller and wipe it thoroughly with 100% ethanol and a cotton swab, or lint-free cloth.</p>	<p>Clean the platen roller when changing a new label roll</p>
<p>Tear Bar/Peel Bar</p>	<p>Use the lint-free cloth with 100% ethanol to wipe it.</p>	<p>As needed</p>
<p>Sensor</p>	<p>Compressed air or vacuum</p>	<p>Monthly</p>
<p>Exterior</p>	<p>Wipe it with water-dampened cloth</p>	<p>As needed</p>
<p>Interior</p>	<p>Brush or vacuum</p>	<p>As needed</p>

Note:

- Do not touch printer head by hand. If you touch it careless, please use ethanol to clean it.
- Please use 100% Ethenol. DO NOT use medical alcohol, which may damage the printer head.
- Regularly clean the print head and supply sensors once change a new ribbon to keep printer performance and extend printer life.

Revise History

Date	Content	Editor
2012/6/18	* Revise pictures of label roll guard * Revise section 1.6	Cinya
2012/9/24	* Revise chapter 2.2.2, 2.5.1, 2.6.1 and 2.6.2	Camille
2012/10/2	* Revise chapter 2.6.3, 2.6.5 and 3.1.2	Camille
2013/4/1	* Modify chapter 1.2.2 for cutter spec * Modify chapter 3.3.1 for V7.0 F/W (Self-test) * Add TSC YouTube web address	Camille
2013/5/8	* Modify chapter 1.3	Camille
2014/11/5	Add UL caution	Camille
2015/4/30	Modify 1.2.2 section	Camille
2017/8/24	Modify chapter 1.2.2 for cutter spec	Camille



TSC Auto ID Technology Co., Ltd.

Corporate Headquarters

9F., No.95, Minquan Rd., Xindian Dist.,
New Taipei City 23141, Taiwan (R.O.C.)

TEL: +886-2-2218-6789

FAX: +886-2-2218-5678

Web site: www.tscprinters.com

E-mail: printer_sales@tscprinters.com

tech_support@tscprinters.com

Li Ze Plant

No.35, Sec. 2, Ligong 1st Rd., Wujie Township,
Yilan County 26841, Taiwan (R.O.C.)

TEL: +886-3-990-6677

FAX: +886-3-990-5577