

Memor™ X3 Mobile Computer



User's Manual

Datalogic S.r.l.

Via San Vitalino 13

40012 Calderara di Reno (BO)

Italy

Tel. +39 051 3147011

Fax +39 051 3147205

©2013-2018 Datalogic S.p.A. and/or its affiliates.

♦ All rights reserved.♦ Without limiting the rights under copyright, no part of this documentation may be reproduced, stored in or introduced into a retrieval system, or transmitted in any form or by any means, or for any purpose, without the express written permission of Datalogic S.p.A. and/or its affiliates. Owners of Datalogic products are hereby granted a non-exclusive, revocable license to reproduce and transmit this documentation for the purchaser's own internal business purposes. Purchaser shall not remove or alter any proprietary notices, including copyright notices, contained in this documentation and shall ensure that all notices appear on any reproductions of the documentation. Should future revisions of this manual be published, you can acquire printed versions by contacting your Datalogic representative. Electronic versions may either be downloadable from the Datalogic website (www.datalogic.com) or provided on appropriate media. If you visit our website and would like to make comments or suggestions about this or other Datalogic publications, please let us know via the "Contact Datalogic" page.

Disclaimer

Datalogic has taken reasonable measures to provide information in this manual that is complete and accurate, however, Datalogic reserves the right to change any specification at any time without prior notice. Datalogic and the Datalogic logo are registered trademarks of Datalogic S.p.A. in many countries, including the U.S.A. and the E.U.

Memor is a trademark of Datalogic S.p.A. and/or its affiliates. All other brand and product names may be trademarks of their respective owners.

Patents

See www.patents.datalogic.com for patent list.

CONTENTS

| | |
|---|------------|
| REFERENCES | VI |
| Conventions | vi |
| Reference Documentation | vi |
| Support Through the Website | vi |
| Warranty Terms and Conditions | vi |
| GENERAL VIEW | VII |
| 1 INTRODUCTION | 1 |
| 1.1 Memor X3 Description..... | 1 |
| 1.2 Available Models..... | 3 |
| 1.3 Package Contents..... | 4 |
| 1.4 Inserting a MicroSD Card..... | 5 |
| 1.5 Removing the MicroSD Card | 8 |
| 1.6 Accessories..... | 9 |
| 2 BATTERIES AND MAINTENANCE | 10 |
| 2.1 Charging the Battery Pack | 10 |
| 2.2 Replacing the Battery Pack..... | 12 |
| 2.3 Cleaning the Mobile Computer..... | 16 |
| 3 CONNECTIONS | 17 |
| 3.1 USB Connection | 17 |
| 3.2 Connection to USB Peripherals | 19 |
| 3.3 RS232 Connection | 21 |
| 3.4 WLAN Connection | 22 |
| 3.5 WPAN Connections | 24 |
| 3.6 Connection Cables..... | 25 |
| 3.7 Wireless and Radio Frequencies Warnings | 26 |
| 4 USE AND FUNCTIONING | 28 |
| 4.1 Startup | 28 |
| 4.1.1 Using the Stylus | 30 |
| 4.2 Data Capture..... | 31 |
| 4.2.1 Laser Data Capture..... | 32 |
| 4.2.2 Imager Data Capture..... | 33 |
| 4.2.3 Linear Imager Data Capture..... | 35 |
| 4.3 Description of the Keyboards | 37 |
| 4.3.1 Resetting the Memor X3 | 40 |
| 4.4 Status Indicators | 42 |
| 4.4.1 LED Status..... | 42 |
| 4.4.2 Taskbar | 43 |
| 4.5 Control Panel | 44 |
| 4.5.1 Data Capture Configuration | 45 |
| 4.5.2 Configure | 46 |

| | | |
|----------|--|------------|
| 4.5.3 | Capture | 48 |
| 4.5.4 | DL Buttons | 49 |
| 4.5.5 | Registry..... | 55 |
| 4.5.6 | Files Admin | 56 |
| 4.5.7 | Wireless Communications..... | 59 |
| 4.5.8 | Stylus Calibration | 64 |
| 4.5.9 | Audio Settings..... | 67 |
| 4.6 | Connecting to Other Computers | 69 |
| 4.6.1 | Windows Mobile® Device Center..... | 69 |
| 4.6.2 | Bluetooth® Manager Device Setup..... | 71 |
| 4.6.3 | FTP Server Setup | 79 |
| 4.7 | Backup Directory File Management | 80 |
| 4.8 | Datalogic Firmware Utility | 81 |
| 4.8.1 | Retrieving a Firmware Image Update | 81 |
| 4.8.2 | Installing DFU on the Host PC | 82 |
| 4.8.3 | Updating the Firmware..... | 83 |
| 4.9 | Datalogic Configuration Utility | 84 |
| 4.10 | Datalogic Desktop Utility | 85 |
| 4.10.1 | Administrative Options (Admin tab)..... | 86 |
| 4.10.2 | Locked Web Browser Options (LockedWeb tab) | 89 |
| 4.10.3 | Status Icons Options (Status Tab) | 94 |
| 4.10.4 | Windows Controls | 95 |
| 4.10.5 | AppSelector Options (AppSelect tab)..... | 97 |
| 4.11 | AppSelector (Application Selector) | 100 |
| 4.12 | Locked Web Browser | 101 |
| 4.12.1 | Locked Web Browser Special Metatags | 103 |
| 5 | TECHNICAL FEATURES | 107 |
| 5.1 | Technical Data | 107 |
| 5.2 | Reading Diagrams | 112 |
| 6 | TEST CODES | 115 |
| | REGULATORY INFORMATION..... | 119 |
| | General Safety Rules | 119 |
| | Power Supply..... | 119 |
| | Laser Safety..... | 120 |
| | LED Class | 126 |
| | Canadian Statement | 126 |
| | Marking and European Economic Area (EEA) | 127 |
| | Statement of Compliance..... | 127 |
| | Statement of Compliance..... | 127 |
| | Frequency Ranges..... | 130 |
| | FCC Compliance..... | 131 |
| | Industry Canada Compliance..... | 133 |
| | SAR Compliance..... | 134 |
| | WEEE Compliance | 135 |

GLOSSARY 137
INDEX 141

REFERENCES

CONVENTIONS

This manual uses the following conventions:

“User” refers to anyone using a Memor X3 mobile computer.

“mobile computer” and “Memor X3” refer to Memor X3 mobile computer.

“You” refers to the System Administrator or Technical Support person using this manual to install, configure, operate, maintain or troubleshoot a Memor X3 mobile computer.

“Single Dock” refers to the Memor X3 Single Slot Dock.

The label artworks may be only a draft. Refer to the product labels for more precise information.

REFERENCE DOCUMENTATION

For further information regarding Memor X3 refer to the SDK Help on-Line.

SUPPORT THROUGH THE WEBSITE

Datalogic provides several services as well as technical support through its website. Log on to www.datalogic.com and click on the **SUPPORT** link which gives you access to:

Downloads by selecting your product model from the dropdown list in the Search by Product field for specific Data Sheets, Manuals, Software & Utilities, and Drawings;

Repair Program for On-Line Return Material Authorizations (RMAs) plus Repair Center contact information;

Customer Service containing details about Maintenance Agreements;

Technical Support through email or phone.

WARRANTY TERMS AND CONDITIONS

The warranty period is 1 year for the device and 90 days for consumables (e.g. battery, power supply, cable etc.) from date of purchase at our company.

GENERAL VIEW



- A) QVGA 64K Color Display*
- B) ON/OFF Power Key
- C) Speaker
- D) LEDs
- E) Scan Key
- F) Keyboard
- G) Guitar Pick Stylus

- H) Microphone
- I) Laser Safety Label
- J) Rear Speaker
- K) Product Label (under battery)
- L) Battery Cover
- M) Side scan key (on both sides of the mobile computer)

- N) QVGA 64K Color Display
- O) Good Read or User Programmable LED
- P) Charging Status LED

- T) Microphone
- U) Strap with Stylus Holder
- V) Laser Safety Label
- W) Rear Speaker

- Q) Speaker
- R) Scan Key
- S) Keyboard

- X) ON/OFF Power Key
- Y) Product Label (under battery)
- Z) Battery Cover



- N) Data Capture Window*
- O) DC Charger Connector

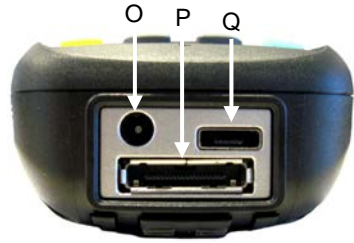

- P) Communication/Charger Connector (through cradle)
- Q) Micro USB Communication Connector (through cable)

* Remove protective film cover before use

1 INTRODUCTION

1.1 MEMOR X3 DESCRIPTION

Following the Datalogic Memor in the compact segment of Portable Data Terminals, the Memor X3 mobile computer is Datalogic's ultimate solution offering ease of use, power and durability in a pocketable form factor.

The Memor X3 features a bigger and crisper display (2.4") and longer-lasting batteries (1430 and 2300 mAh) in a form factor that has the same shape (only 3mm longer) and the same weight as its predecessor. In addition to the models with Laser and with 2D Imager, its offer of scan engines now includes a CCD Linear Imager, so as to address the needs of a wider range of customer applications.

The Memor X3 is built on the microprocessor XScale™ PXA310, working with a clock speed of 806 MHz. The RAM and Flash Memory have been increased to 256 Mb and 512 Mb in order to offer more space for running simultaneous applications, for managing large databases, or for use with asynchronous/thick clients when off-line autonomy is required. Moreover, the memory storage capacity can be further increased through the user accessible Micro SD Card Slot.

The Memor X3 computer architecture is paired with Microsoft Windows CE 6.0 operating system, offered in 2 different versions: (1) Windows CE 6.0 Pro, bundled with Microsoft WordPad and Internet Explorer; (2) Windows CE 6.0 Core, bundled in a lighter package without browser and with a lighter set of features (e.g. no RDP, no WordPad, no AYGShell).

The software development kit (SDK) for Memor X3 enables to create applications under Windows CE (both Pro and Core) or under multi-platform environments such as .NET.

The Memor X3 offers enhanced WiFi connectivity IEEE 802.11abgn, able to work in both the bands 2.4GHz and 5.2GHz. Complemented by a CCX v4 security certification from Cisco, the Datalogic Memor X3 provides infrastructure compatibility focused on enterprise requirements for encrypted communication and seamless roaming. In addition to that, the Bluetooth® Wireless Technology v2.1 with Enhanced Data Rate (EDR) connects headsets, printers and other peripherals while eliminating cumbersome wires and costly replacement of damaged cables.

Durability ratings protect the computing investment against accidental drops and occasional exposure to liquids and dust. A Gorilla Glass 2 makes the scan window in front of the laser engines resistant to accidental scratching and damage.

* except for models with CCD scan engine, featuring a 624 MHz clock speed and 128-Mb RAM

The Wavelink® maintenance and management tools make the Datalogic Memor X3 a simple device to both deploy and maintain. Datalogic Firmware, Desktop and Configuration Utilities, as well as a new Locked Web Browser complete the package with unprecedented ability to customize device configuration to the different use environments and processes.

1.2 AVAILABLE MODELS

The Memor is available in different models depending on the options it is equipped with. All options are listed below:

- communication options: WiFi IEEE 802.11abgn + Bluetooth®, Batch
- data capture options: laser, 2D imager, CCD linear imager
- operating system: Windows CE 6.0 Pro, Windows CE 6.0 Core

For further details about the Memor models refer to the web site:

<http://www.datalogic.com>.

For further information regarding Windows CE refer to the website:

<http://www.microsoft.com/windowseembedded>.

The currently available models are:

- 944250001 Memor X3, Batch, 128 MB RAM/512 MB Flash, 624 MHz, 25-key Numeric, Linear Imager with Green Spot, Windows CE Core 6.0
- 944250002 Memor X3, 802.11 a/b/g/n CCX V4, Bluetooth®, 128 MB RAM/512 MB Flash, 624 MHz, 25-key Numeric, Linear Imager with Green Spot, Windows CE Core 6.0
- 944250003 Memor X3, Batch, 256 MB RAM/512 MB Flash, 806 MHz, 25-key Numeric, Laser with Green Spot, Windows CE Pro 6.0
- 944250004 Memor X3, 802.11 a/b/g/n CCX V4, Bluetooth®, 256 MB RAM/512 MB Flash, 806 MHz, 25-key Numeric, Laser with Green Spot, Windows CE Pro 6.0
- 944250005 Memor X3, 802.11 a/b/g/n CCX V4, Bluetooth®, 256 MB RAM/512 MB Flash, 806 MHz, 25-key Numeric, 2D Imager with Green Spot, Windows CE Pro 6.0

1.3 PACKAGE CONTENTS

The Memor X3 package contains:

- 1 Memor X3 mobile computer
- 1 AC/DC power supply
- 1 plug kit
- 1 standard Micro USB cable
- 1 hand strap with stylus holder (Windows CE Pro models only)
- 1 extensible stylus (Windows CE Pro models only)
- 1 guitar pick + cord
- 1 Quick Start Guide
- 1 Safety and Regulatory Addendum
- 1 Wavelink Avalanche Insert
- 1 End User License Agreement (EULA) Sheet

Remove all the components from their packaging; check their integrity and compare them with the packing documents.



CAUTION

Keep the original packaging for use when sending products to the technical assistance center. Damage caused by improper packaging is not covered under the warranty.



NOTE

Rechargeable battery packs are not initially fully charged. Therefore the first operation to perform is to charge them. See section 2.1.

1.4 INSERTING A MICROSD CARD

The Memor X3 supports microSD memory cards. To access the microSD card slot and insert the card, proceed as follows:

1. Turn off the Memor X3.
2. Press the latch release button and pull the latch down; then remove the cover and the battery pack:



3. Open the microSD card slot by lifting up the locking plate:



- Shift the cardholder upwards and then pull it up:



- Insert the microSD card with the written part upward:



- Lock the card into place by pushing the cardholder down and then shifting it downwards; push the locking plate down:



7. Reinsert the battery cover. First insert first the upper side and then press the latch release button and pull the latch down to insert the bottom. Push the knurled section of the latch upward to close the cover.



1.5 REMOVING THE MICROSD CARD

To remove the microSD card, follow the steps above to access the SD area, and remove it from its slot.



CAUTION

Follow proper ESD precautions to avoid damaging the microprocessors in the Memor X3 or the microSD card itself.

Proper ESD precautions include, but are not limited to, working on an ESD mat and ensuring that the operator is properly grounded.

Do not force the card. If you feel resistance, remove the card, check the orientation, and reinsert it.

Do not use the microSD card slot for any other accessories.

1.6 ACCESSORIES

❑ Cradles

- 94A150058 DOCK, SINGLE SLOT, MEMORX3 w AUX. SLOT
- 94A150059 DOCK, ETHERNET SINGLE SLOT, MEMORX3
- 94A150060 CHARGER, 4 SLOT DOCK, MEMORX3

❑ Batteries

- 94ACC0083 MEMOR X3 STANDARD BATTERY
- 94ACC0084 MEMOR X3 LARGE CAPACITY BATTER

❑ Power Supply

- 94ACC1324 PG5-30P35 AC/DC POWER SUPPLY EU/USA PLUG
- 94ACC1334 PG5-30P35 AUS. PLUG ADAPTER
- 94ACC1335 PG5-30P35 UK PLUG ADAPTER
- 94ACC1339 PG5-30P35 EU. PLUG ADAPTER

❑ Cables

- 94A051020 CAB-427 RS232 NULL MODEM CABLE
- 94A051022 WIN-NET Serial CAB (HRS ST40x-18S-CV)
- 94A051024 USB A (4 pin F) to Mini A (5 pin M)
- 94A051968 Cable, Micro USB, Client
- 94A051969 Cable, Micro USB, Host

**NOTE**

Use only Datalogic approved power supply and cables. Use of an alternative power supply will invalidate any approval given to this device and may be dangerous.

2 BATTERIES AND MAINTENANCE

**NOTE**

By default, the main battery pack is disconnected at the factory to avoid damage due to excessive draining.

**CAUTION**

Annual replacement of rechargeable battery pack avoids possible risks or abnormalities and ensures maximum performance.

2.1 CHARGING THE BATTERY PACK

Memor X3 battery pack is not initially fully charged. After installing the battery, charge it with the power supply or with the single dock. Moreover recharging is possible by USB Direct connection with the host computer, but with longer charging times and only if the mobile computer off.

**NOTE**

The battery pack autonomy varies according to many factors, such as the frequency of barcode scanning, RF usage, battery life, storage, environmental conditions, etc.

The battery icon on the Taskbar indicates when the battery pack is low.

During the charging process the LED positioned at the right side of the display glows red constantly. Once the charging process has been completed this LED glows green constantly (see par. 4.4).

The stand alone battery pack may be charged using the spare battery charging slot on the back of the single slot dock or the multi battery charger.

**CAUTION**

Do not use the Memor X3 until batteries are charged for minimum 4 hours.

**CAUTION**

*Risk of explosion if battery is replaced by an incorrect type.
Dispose of used batteries according to the instructions.*

**CAUTION**

*Il y a risque d'explosion si la batterie est remplacée par une batterie de type incorrect.
Mettre au rebut les batteries usagées conformément aux instructions.*

**CAUTION**

*Avoid storing batteries for long periods in a state of full charge or very low charge.
We recommend charging the battery pack every two to three months to keep its charge at a moderate level to maximize battery life.*

**NOTE**

Even if the storage temperature range is wider, in order to achieve the longest battery life, store the terminal and the spare batteries between 20 to 30° C (68 to 86° F).

Memor X3 (including spare battery) should be charged at an ambient temperature between 0° to +40 °C (+32° to +104 °F) to achieve the maximum charging rate. Never charge the main device or spare batteries in a closed space where excessive heat can build up.

**NOTE**

The battery level may display incorrectly for several minutes after the Memor X3 is disconnected from its charger if the charging cycle is not completed.

**NOTE**

The Memor X3 may get warm during charging; this is normal and does not mean a malfunction.

**NOTE**

Use only a USB-IF compliant USB port as a charging source.

2.2 REPLACING THE BATTERY PACK

To correctly replace the battery pack, proceed as follows.

1. Turn off the Memor X3 .
2. Press the latch release button and pull the latch down; then remove the battery cover:



3. Install the new battery pack, first insert the upper side (contacts), then the bottom side of the battery pack into the slot:



4. Reinsert the cover. First insert the upper side and then press the latch release button and pull the latch down to insert the bottom. Push the knurled section of the latch upward to close the cover:

**WARNING**

Installing, charging and/or any other action should be done by authorized personnel and following this manual.

The battery pack may get hot, explode, ignite, and/or cause serious injury if exposed to abusive conditions.

If the battery pack is replaced with an improper type, there is risk of explosion and/or fire.

Do not place the battery pack in or near a fire or other heat source; do not place the battery pack in direct sunlight, or use or store the battery pack inside unventilated areas in hot weather; do not place the battery pack in microwave ovens, in clothes dryers, in high pressure containers, on induction cook surfaces or similar devices. Doing so may cause the battery pack to generate heat, explode or ignite. Using the battery pack in this manner may also result in a loss of performance and a shortened life expectancy.

Use only a Datalogic approved power supply. The use of an alternative power supply will void the product warranty, may cause product damage and may cause heat, an explosion, or fire.

The area in which the units are charged should be clear of debris and combustible materials or chemicals.

Do not use the battery pack of this terminal to power devices other than this mobile computer.

Immediately discontinue use of the battery pack if, while using, charging or storing the battery pack, the battery pack emits an unusual smell, feels hot, changes colour or shape, or appears abnormal in any other way.

**WARNING**

Do not short-circuit the battery pack contacts connecting the positive terminal and negative terminal. This might happen, for example, when you carry a spare battery pack in your pocket or purse; accidental short-circuiting can occur when a metallic object such as a coin, clip, or pen causes direct connection of the contacts of the battery pack (these look like metal strips on the battery pack). Short-circuiting the terminals may damage the battery pack or the connecting object.

Do not apply voltages to the battery pack contacts.

Do not pierce the battery pack with nails, strike it with a hammer, step on it or otherwise subject it to strong impacts, pressures, or shocks.

Do not disassemble or modify (i.e. bend, crush or deform) the battery pack. The battery pack contains safety and protection devices, which, if damaged, may cause the battery pack to generate heat, explode or ignite.

In case of leakage of liquid from the battery, avoid contact with liquid the skin or eyes. If the contact occurs, immediately wash the affected area with water and consult a doctor.

Do not solder directly onto the battery pack.

Do not expose the battery pack to liquids.

Avoid any knocks or excessive vibrations. If the device or the battery is dropped, especially on a hard surface, you should take it to the nearest Authorised Repair Centre for inspection before continuing to use it.

If your device stops working for any reason, do not use its battery on other electronic devices without a prior check and approval by an authorized repair center.

Do not replace the battery pack when the device is turned on.

Do not remove or damage the battery pack's label.

Do not use the battery pack if it is damaged in any part.

Battery pack usage by children should be supervised.

Collect and recycle waste batteries separately from the device in compliance with European Directive 2006/66/EC, 2011/65, 2002/96/EC and subsequent modifications, with US and China regulatory laws and regulations about the environment.

**NOTE**

To maximize operating autonomy, the Memor X3 checks its battery level at all times. If the battery is not sufficiently charged, the Memor X3 will not turn on when the ON/OFF Power button is pressed. In this case, either substitute a sufficiently charged battery, insert the Memor X3 into a powered cradle, or plug it into a wall charger.

**NOTE**

To maximize battery life, turn off radios when they are not needed.

2.3 CLEANING THE MOBILE COMPUTER

Periodically clean the Memor X3 with a slightly dampened cloth.

Do not use alcohol, corrosive products or solvents.

3 CONNECTIONS

3.1 USB CONNECTION

You can use any standard micro USB cable to directly connect the Memor X3 to a host computer to transfer data through the USB interface.



Key:

A Host computer

C Memor X3

B Standard Micro USB cable



NOTE

Connection through the cable is compliant to 2.0 USB standard.

The Single Dock can be connected to the host computer by any standard mini USB cable.

Once the host computer has been turned on, insert the Memor X3 mobile computer into the cradle.

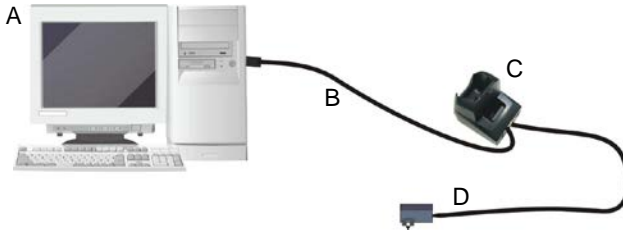

Key:

A Host computer

C Single Slot Dock

B Standard mini USB cable

D Power Supply



NOTE

Connection through the cradle complies to USB 2.0 standard.



NOTE

The actual data transfer speed can be appreciably lower than the maximum theoretical speed.

3.2 CONNECTION TO USB PERIPHERALS

You can connect the Memor X3 to a standard USB keyboard or to a standard USB flash memory device. Connect the terminal to a standard A (4 pin female) to micro A (5 pin male) USB cable. For all these devices maximum current draw must be less than 100mA.

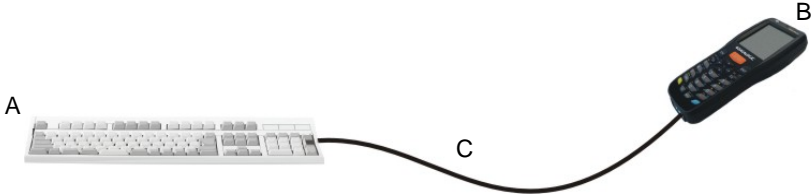

Key:

A Keyboard with USB interface C 94A051024 (Standard A to Micro A USB cable)

B Memor X3

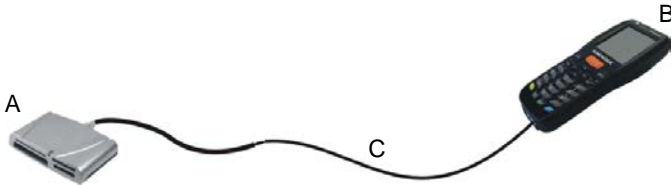

Key:

A USB hard drive/ external memory source C 94A051024 (Standard A to Micro A USB cable)

B Memor X3



NOTE

Connect first the USB peripheral to the cable, and then the cable to the Memor X3.

**NOTE**

Memor X3 works with most of the mentioned USB peripherals. Datalogic cannot guarantee the interoperability of Memor X3 with all devices on the market.

**NOTE**

Connection is compliant to USB 1.1 standard.

**NOTE**

The actual data transfer speed can be appreciably lower than the maximum theoretical speed.

3.3 RS232 CONNECTION

You can use a cable to directly connect the Memor X3 to a host computer to transfer data through the RS232 interface:

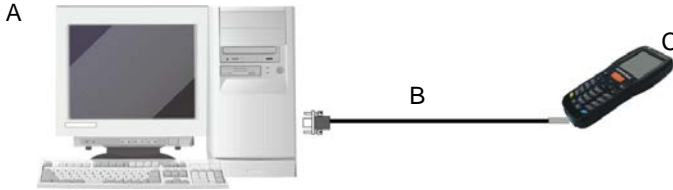

Key:

- A Host computer
- B 94A051022 WIN-NET (HRS ST40X-18S-CV)
- C Memor X3

The Single Slot Dock can be connected to the Host by means of a standard null modem cable such as Datalogic 94A051020 CAB-427 for 9-pin connections.

Once the host computer has been turned on, insert the Memor X3 mobile computer into the dock.

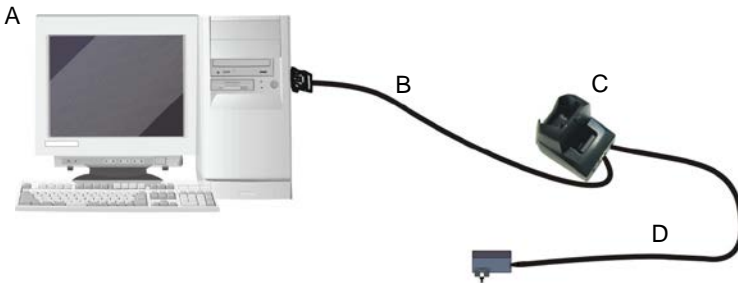

Key:

- A Host Computer
- B 94A051020 CAB-427 RS232 Null Modem Cable
- C Single Slot Dock
- D Power Supply (only necessary for battery charging)*

*In this case the power supply is only necessary for battery charging. Insert the power supply into the power jack on the base of the cradle and attach the power supply to a power outlet.

3.4 WLAN CONNECTION

Memor X3 802.11 abgn radio models can communicate with the host using the on-board Wi-Fi radio and an Access Point connected to a network.

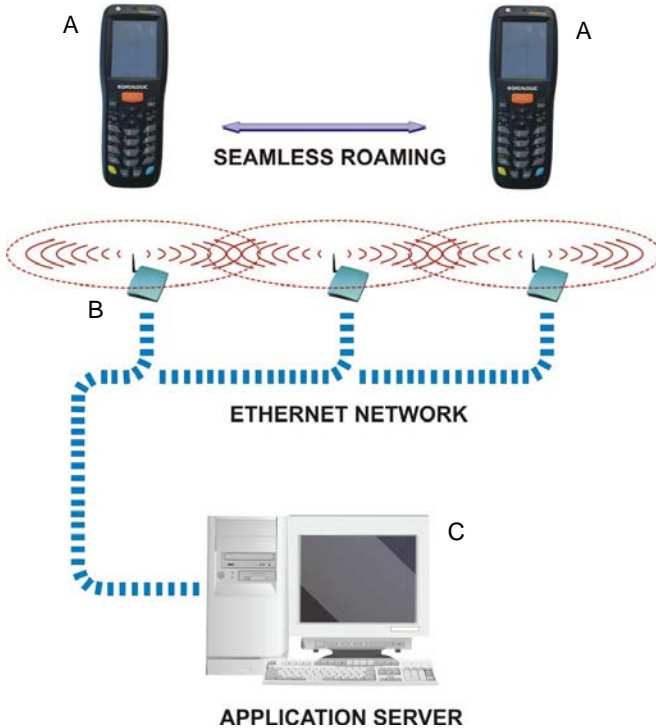

Key:

- A) Memor X3
- B) Access point
- C) Host – Application Server

**NOTE**

802.11 abgn radio module is on by default. In order to avoid wasting energy, you can switch it off using the Wireless Communications applet.

**NOTE**

Suspending the terminal powers off the 802.11 abgn radio and drops the radio connection. When the terminal resumes, depending on the radio power mode and security protocol selected, it may take up to 30 seconds for the 802.11 abgn radio driver to re-associate the radio to the network.

**NOTE**

Area coverage and radio performance may vary, due to environmental conditions, access points types or interference caused by other devices (microwave ovens, radio transmitters, etc.).

**NOTE**

In case of heavy usage the Memor X3 may get warm; this is normal and does not mean a malfunction.

3.5 WPAN CONNECTIONS

Memor X3 Bluetooth® models can communicate with a Bluetooth® device, such as a printer, within a range of 10 m, using the on-board Bluetooth® module.



Key:

A) Memor X3

B) Bluetooth® printer



NOTE

In order to extend battery life, the Bluetooth® module is off by default. If you need to have Bluetooth® working, the module must be powered on by using the Bluetooth Manager and performing the Discovery procedure (see par. 4.6.2).



NOTE

Suspending the terminal powers off the Bluetooth® radio and drops the piconet (Bluetooth® connection). When the terminal resumes, it takes approximately 10 seconds for the Bluetooth® radio driver to re-initialize the radio.



NOTE

Area coverage and Bluetooth® radio performance may vary, due to environmental conditions or interference caused by other devices (microwave ovens, radio transmitters, etc.).

3.6 CONNECTION CABLES

- ❑ **RS232 Direct Connection:**
94A051022 WIN-NET SERIAL CAB (HRS ST40x-18S-CV)

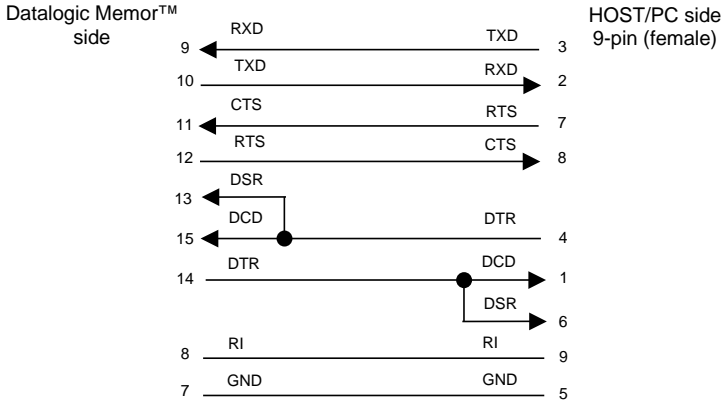

- ❑ **Power Supply Polarity:**

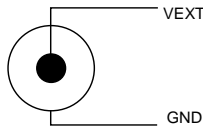

3.7 WIRELESS AND RADIO FREQUENCIES WARNINGS

**WARNING**

Use only the supplied or an approved replacement antenna. Unauthorized antennas, modifications or attachments could damage the product and may violate laws and regulations.

The antennas inside the Memor X3 are not user-accessible and cannot be replaced by end users. Send any faulty equipment to Datalogic for repair.

**WARNING**

Most modern electronic equipment is shielded from RF signals. However, certain electronic equipment may not be shielded against the RF signals generated by Memor X3.

**WARNING**

Datalogic recommends persons with pacemakers or other medical devices to follow the same recommendations provided by Health Industry Manufacturers Associations for mobile phones.

Persons with pacemakers:

- *Should ALWAYS keep this device more than twenty five (25) cm from their pacemaker and/or any other medical device;*
- *Should not carry this device in a breast pocket;*
- *Should keep the device at the opposite side of the pacemaker and/or any other medical device;*
- *Should turn this device OFF or move it immediately AWAY if there is any reason to suspect that interference is taking place.*
- *Should ALWAYS read pacemaker or any other medical device guides or should consult the manufacturer of the medical device to determine if it is adequately shielded from external RF energy.*

In case of doubt concerning the use of wireless devices with an implanted medical device, contact your doctor.

**WARNING**

Turn this device OFF in health care facilities when any regulations posted in these areas instruct you to do so. Hospitals or health care facilities may use equipment that could be sensitive to external RF energy.

**WARNING**

RF signals may affect improperly installed or inadequately shielded electronic systems in motor vehicles. Check with the manufacturer or its representative regarding your vehicle. You should also consult the manufacturer of any equipment that has been added to your vehicle.

**WARNING**

An air bag inflates with great force. DO NOT place objects, including either installed or portable wireless equipment, in the area over the air bag or in the air bag deployment area. If a vehicle's wireless equipment is improperly installed and the air bag inflates, serious injury could result.

**WARNING**

Turn off the device when in any area with a potentially explosive atmosphere. Observe restrictions and follow closely any laws, regulations, warnings and best practices on the use of radio equipment near fuel storage areas or fuel distribution areas, chemical plants or where any operation involves use of explosive materials.

Do not store or carry flammable liquids, explosive gases or materials with the device or its parts or accessories.

Areas with a potentially explosive atmosphere are often, but not always, clearly marked or shown.

Sparks in such areas could cause an explosion or fire, resulting in injury or even death.

4 USE AND FUNCTIONING

The use of the Memor X3 depends on the application software loaded. However there are several parameters that can be set and utilities that can be used to perform some basic functions such as data capture, communications, file management, etc

4.1 STARTUP

The Memor X3 turns on when the battery pack or the external supply is inserted.

After the battery pack is installed, use the [ON/OFF] key to turn the mobile computer on and off.

As soon as the mobile computer is on, the user will be asked to calibrate the screen (see par.4.5.10). Then, the Windows CE 6.0 desktop will appear on the screen. Wait a few seconds before starting any activity so that the mobile computer completes its startup procedure.

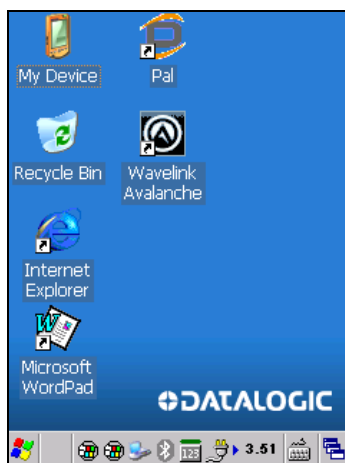

Desktop

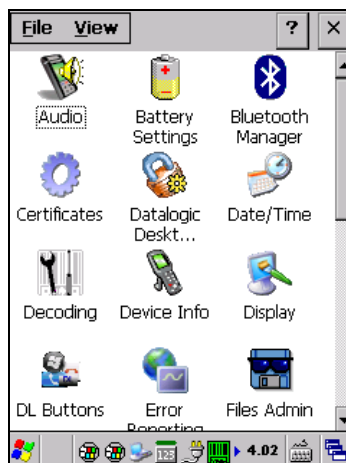

Control Panel

Use the stylus (par. 4.1.1) as suggested to select icons and options.

The mobile computer goes into power-off (low power with display and keyboard backlight off), when it is not used for more than a programmable timeout, which is defined in the POWER applet of the Control Panel. In this mode it can be awakened

(resuming operation) by the [ON/OFF] key, by the SCAN key, or by inserting/extracting the device onto/from the cradle.

**NOTE**

The mobile computer can also be awakened or suspended programmatically.

4.1.1 Using the Stylus

The stylus selects items and enters information. The stylus functions like a mouse.

| | |
|----------------------|---|
| Double Tap: | Double tap the screen with the stylus to open items and select options. |
| Drag: | Hold the stylus on the screen and drag across the screen to select text and images. Drag in a list to select multiple items. |
| Tap-and-hold: | Tap and hold the stylus on an item to see a list of actions available for that item. On the pop-up menu that appears, tap the action you want to perform. |

To recalibrate the touch screen use the Stylus applet (see par. 4.5.10).



CAUTION

Use only original Datalogic styluses supplied with the product itself.

In harsh applications, use of screen protectors should be taken into consideration, in order to extend the touch screen operating life.

To prevent damage to the screen, do not use sharp devices or any device other than the Datalogic provided stylus.

Do not apply too much pressure when touching the screen.

For applications where an intensive use of the touch screen is foreseen, please consider that touch screen components are subject to progressive wear.

4.2 DATA CAPTURE

To capture data tap Start > Settings > Control Panel > double tap Decoding:

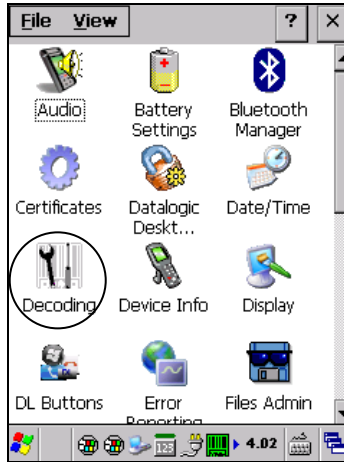

To configure and enable data capture parameters refer to par. 4.5.1.

4.2.1 Laser Data Capture

To scan barcodes, point the Memor X3 laser model onto the code from a distance within the reading range while pressing the SCAN key.

The lighted band emitted by the laser must completely cross the barcode as shown in the figure below.

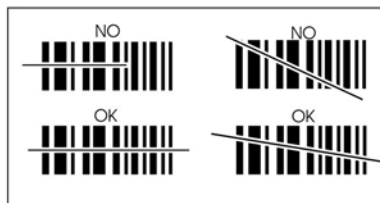

If the scan has taken place correctly:

- the Good Read LED glows steadily Green for a configurable time;
- if enabled, the Good Read Beep plays;
- if enabled, the GreenSpot projects a green spot onto the bar code image.

**NOTE**

Remove the protective film cover over the data capture window before use.

4.2.2 Imager Data Capture

The Memor X3 Imager captures a picture of the entire bar code. The omni-directional scanning does not require that the operator orient the bar code to align with the scan pattern.

To read a 1D or 2D code, simply point the Memor X3 Imager model onto the code and press the SCAN Key or the pistol trigger.



The Memor X3 Imager uses an intelligent aiming system pattern, indicating the field of view, which should be positioned over the code:

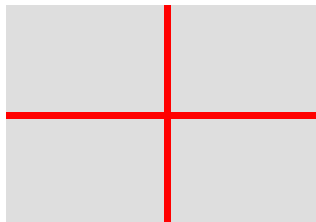

Aiming System

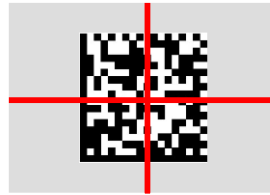
Linear barcode**2D Matrix symbol****Relative Size and Location of Aiming System Pattern**

The field of view changes its size as you move the reader closer or farther away from the code. The field of view indicated by the aiming system pattern will be smaller when the Memor X3 Imager is closer to the code and larger when it is farther from the code.

Symbologies with smaller bars or elements (mil size) should be read closer to the unit. Symbologies with larger bars or elements (mil size) should be read farther from the unit. (See par. 5.1 for further details).

If the scan has taken place correctly:

- the Good Read LED glows steadily Green for a configurable time;
- if enabled, the Good Read Beep plays;
- if enabled, the GreenSpot projects a green spot onto the bar code image.

4.2.3 Linear Imager Data Capture

Point the Memor X3 linear imager model onto the code, at a distance within the reading range, and press the SCAN key. Make sure that the lighted band emitted by the linear imager crosses the barcode to read end-to-end.

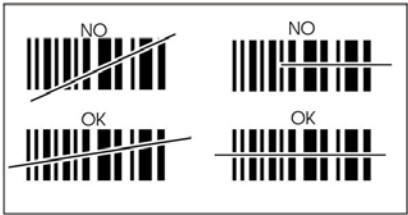

When beams reflect directly back into the scanner from the bar code, they can “blind” the scanner and make decoding difficult.

To avoid this, don't keep the terminal perpendicular to the barcode: moving it of a small angle of $\pm 2^\circ$ is usually enough to enable proper reading. But don't scan at too oblique an angle either: keep the scanner within an angle of $\pm 30^\circ$ from the perpendicular to the barcode in order to guarantee effective scanning.

Side Views

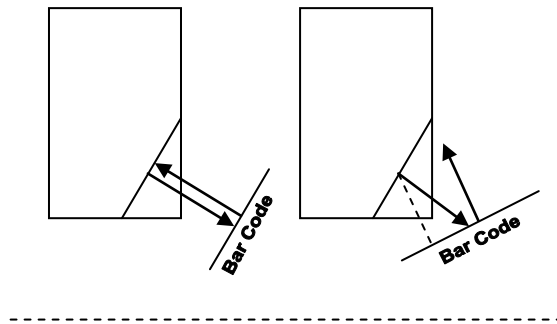







4.3 DESCRIPTION OF THE KEYBOARDS





The Memor X3 comes with a 25-key numeric keyboard, complemented by 2 additional side keys and by an ON/OFF key.



Main Keys Function

| KEY | FUNCTION |
|---|--|
|  | The SCAN key starts data capture. |
|  | The navigation keys let you move leftwards, rightwards, upwards or downwards, scroll through a Menu list, browse among folder files or select functions if pressed down. |
|  | Yellow modifier (one shot key): when pressed before a standard key, it enables the character or function printed in yellow above the key. |
|  | Blue modifier (one shot key): when pressed before a standard key, it enables the character or function printed in blue above the key |
|  | The ON/OFF Power button powers the Memor X3 ON or OFF. It is placed on the upper left side of the terminal. |
|  | The ALPHA key is used to alternate numeric and alphanumeric typing. |

Special Function Icons

| ICON | FUNCTION |
|---|---|
|  | After a blue modifier key press, it opens the Start menu. |
|  | After a blue modifier key press, it opens the file manager. |
|  | After a blue modifier key press, it switches ON/OFF the display backlight. |
|  | After a blue modifier key press, it switches ON/OFF the keyboard backlight. |
|  | After a blue modifier key press, it locks and unlocks the keyboard. |



After a blue modifier key press, it enables a cursor controlled by the navigation keys. It also enables to use side buttons as the left and right mouse buttons.

4.3.1 Resetting the Memor X3

There are several reset methods for the Memor X3.

A warm boot terminates an unresponsive application and clears the working RAM, but preserves both the file system and the registry.

A cold boot forces all applications to close and clears working RAM and files not resident on the persistent flash memory. Registry is restored from persistent memory if available or returned to factory default.

A clean boot restores the Memor X3 to factory configuration: registry and file system return to factory default.

| | Warm Boot | Cold Boot | Clean Boot |
|-----------------------------------|-----------|------------------------------------|-----------------|
| Registry | Preserved | Restored from flash (if available) | Factory default |
| Flash Disk (Backup Folder) | Preserved | Preserved | Clean disk |
| RAM File System | Preserved | Factory default | Factory default |

Warm Boot

A warm boot closes all applications, clears the working RAM, but preserves the file system and registry. If an application "hangs" initiate a warm boot to terminate the application.

To perform a warm boot, press these keys simultaneously:



Cold Boot

A cold boot is a complete reset of the Memor X3 in which all applications are forcibly closed and RAM is completely cleared. Registry is restored from persistent memory if a saved copy is available (see 4.5.7) and RAM file system completely erased. You will lose any applications and data (registry too) which are not stored in persistent flash memory.

A cold boot is necessary when the Windows CE operating system locks up and the warm boot command does not work.

To perform a cold boot, press these keys simultaneously:



Clean Boot

A clean boot is a cold boot that causes the device to be restored to factory configuration. The Memor X3 will reset to its factory configuration, clear the working RAM and initialize the file system. You will lose any applications and data stored in persistent flash memory. At the next startup the system will ask to recalibrate the touch screen.

To perform a clean boot, follow these steps:

1. Perform a Cold Boot (see Cold Boot).
2. Quickly release all the keys when the screen goes black.
3. Within 1 second press and hold down the Esc and 0 keys until the Clean boot confirmation shows up.
4. Release the Esc and 0 keys.
5. Enter 1 to proceed with the Clean Boot sequence. Enter 0 to cancel the Clean Boot and proceed with a Cold Boot.

4.4 STATUS INDICATORS

4.4.1 LED Status

The Memor X3 provides three different LEDs signaling the mobile computer status.









| LED | STATUS | |
|---|--------------|---|
| Good Read and General Purpose (left side) | Green | Scanning LED is ON, showing a good decode. |
| | Red | Scanning LED is ON from the time the user hits the scan button (Trigger) until the bar code is decoded. |
| Keyboard Status (center) | Off | Keyboard in primary mode. |
| | Yellow solid | Yellow alternate key mode. |
| | Blue solid | Blue alternate key mode |
| | Pink | CapsLock enabled. |
| Charging Status (right side) | Green | It is constant once the charging process has been completed (full charge). |
| | Red | It is constant while charging. |
| | Red Blinking | It blinks in case of charge fault. |

4.4.2 Taskbar



Windows CE Taskbar

The Taskbar provides information about the time, the battery level, the keyboard function, and the decoding status.

| ICONS | DESCRIPTION |
|---|---|
| Time and Battery Icons | |
| 10.50 | It displays the time. |
|  | It indicates that the battery is charging. |
|  | It shows the battery level. |
| Keyboard Status Icons | |
|  | It indicates that the blue FUNC key has been pressed and is going to affect the next key press. |
|  | It indicates that the yellow FUNC key has been pressed and is going to affect the next key press. |
|  | It indicates that the ALPHA key has enabled the selection of the characters printed in orange. |
|  | It indicates the NUMERIC key selection, the ALPHA key has not been pressed. |
|  | It indicates that the ALPHA key has enabled the selection of the characters printed in orange and the Capslock is active. |
|  | It indicates that the keyboard is locked. |
| Decoding Status Icons | |
|  | It indicates that the decoder is active (green), not active (grey). |

4.5 CONTROL PANEL

From the Start menu, tap Settings then Control Panel. Below is an expanded view of the Control Panel showing all of the applets.

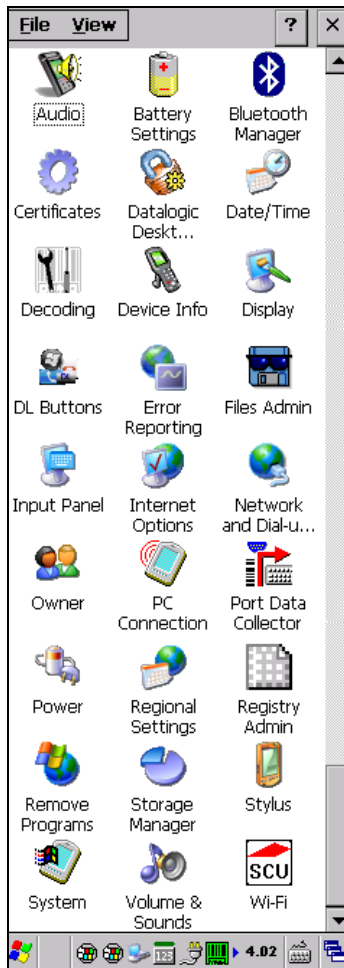

Windows CE Control Panel

4.5.1 Data Capture Configuration

From the taskbar, tap the "Decoding" icon to open a drop-down menu. By selecting the *Info* item from this drop-down menu you can access information about the Scanner and the Software; the *Configure* item opens the configuration applet (Data Capture Configuration Window), while *Capture* accesses the data capture applet (Data Capture Window), which enables code reading. The last menu item (*Wedge*) enables Wedge Emulation.

Decoding can also be accessed from the Control Panel.

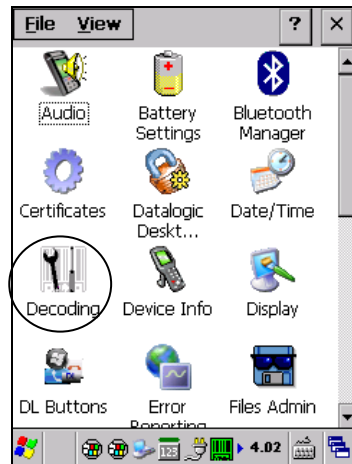
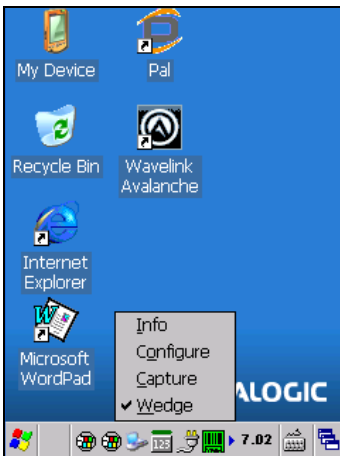

4.5.2 Configure

The Configuration applet contains the barcode scanning configuration parameters in a directory tree structure. The available barcode parameters are divided into two groups: Reader Parameters and Scan Parameters.

The Reader Parameters depend on the type of scanner module installed on the mobile computer and allow barcode configuration (i.e. enable/disable Code 39, check digit control, etc.).

The Scan Parameters are common to all scanner modules and allow control of the scanning device (i.e. beeper control, LED control, laser timeout, etc.).

Each configuration window corresponds to a branch of the tree, and the name of the current branch is displayed at the bottom of each screen window.

| File | Parameter | Window | Help |
|---------------------------|------------------|--------|------|
| | Parameter | Value | |
| | Reader Parame... | ... | |
| | Scan Parameters | ... | |
| | | | |
| | | | |
| | | | |
| | | | |
| | | | |
| | | | |
| | | | |
| | | | |
| Scanner Setup<Parameters> | | | |

Data Capture Configuration Window

The screen format shows two columns where the left column indicates branches or parameters. Branches have three dots in the right column (...). You can navigate through the tree structure using the stylus or keyboard arrows directly on the item field or from the menu.

Parameters have their corresponding current values in the right column. You can edit parameter values using the stylus or keyboard arrows directly on the item field or from the menu. To change a value for example, select the line of the value to be changed, choose Edit from the Parameter Menu then choose a new value from the values listed in the box (see following figures).

| File | Parameter | Window | Help |
|-----------|------------------|----------|------|
| Parameter | edit | | |
| .. | root | Value | |
| .. | .. | .. | |
| Scan | up | 5000 | |
| | GoodReadSound | Beep.wav | |
| | LedDuration | 200 | |
| | LedPulses | 1 | |
| | ContinuousMode | Disabled | |
| | KeyboardEmula... | no | |
| | SoftTrigger | Enabled | |
| | ScanAlwaysOn | Disabled | |
| | NotPrintableChar | Leave | |

Scanner Setup<Scan Parameters>

| File | Parameter | Window | Help |
|-----------|------------------|----------|------|
| Parameter | Value | | |
| .. | .. | | |
| Scan | ScanTimeout | 5000 | |
| | GoodReadSound | Beep.wav | |
| | LedDuration | 200 | |
| | LedPulses | 1 | |
| | ContinuousMode | Disabled | |
| | KeyboardEmula... | no | |
| | SoftTrigger | Enabled | |
| | ScanAlwaysOn | Disabled | |
| | NotPrintableChar | Leave | |

Scanner Setup<Scan Parameters>

LedPulses [X]

1

OK Cancel

Selecting Data Capture Setup Parameters

Alternatively using the stylus, you can tap once directly on the value on the right column; continue tapping until the desired value is reached.

To activate a new configuration select the File ->Save Menu. This will save the configuration to non-volatile memory preventing loss at the next system reset.

The parameters and values are dependent upon the type of scanner module mounted in your mobile computer. For a detailed list of parameters and of their configuration procedures, please refer to the SDK Help file.

4.5.3 Capture

The Data Capture applet (Capture) enables code reading.

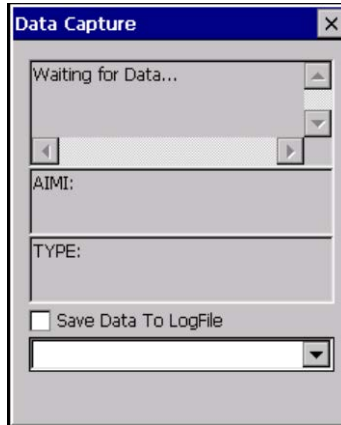

Data Capture Window

Data Capture can also be enabled through the Configuration applet by selecting File ->Scanner from the main menu, or by enabling the parameter Scan Always On in the Scan Parameters branch.

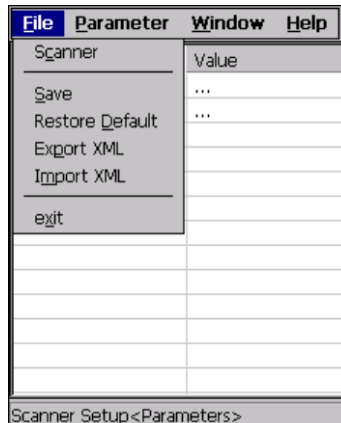

Enabling the Data Capture

4.5.4 DL Buttons

You can use DL Buttons applet to associate specific keys, such as <F1>-<F10>, with specific applications.

From the control panel main window, double tap the DL Buttons icon.

On the DL Buttons tab, customize the program hardware buttons to launch your most used applications. Under 'Select a button', select the button you want to assign a function to, and then select a program from 'Assign a function'.

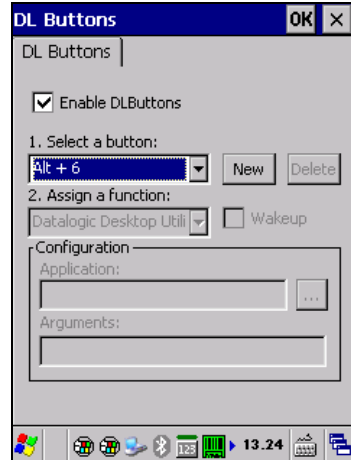
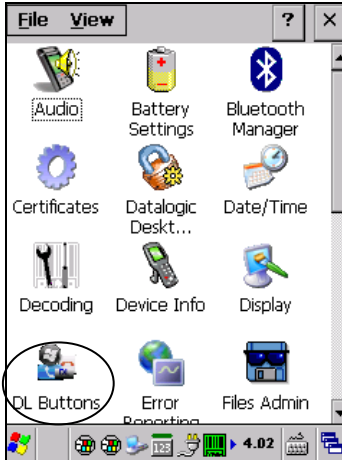

| COMMAND | DESCRIPTION |
|-------------------|---|
| Select a Button | This pull-down list displays the available function keys to define. Select the desired one from the list. |
| New | Select/tap to specify a new Button, which is not on the "Select a Button" list |
| Delete | Tap to delete the selected Button. You can only delete the Buttons you have added. You cannot delete the following buttons: "Alt + 6", "Left Button", "Pistol Trigger", "Right Button", "Scan" |
| Assign a function | This pull-down list displays the available functions. |
| Application | Displays path to the selected application. |
| Browse | Select/tap  to browse for application files. You can associate an executable program with the specified Button. This option is only available when "Launch Application" is selected in the "Assign a function" pull-down list. |
| Arguments | Type the command-line arguments that are needed for the specified application. This option is only available when "Launch Application" is selected in the "Assign a function" pull-down list. |

Adding a new Button

When you select “New” on the “DL Buttons” tab, this opens the “Add Key” dialog box.

To define a new Button, complete the following steps:

1. Enter the key combination in the “Add Key” textbox.

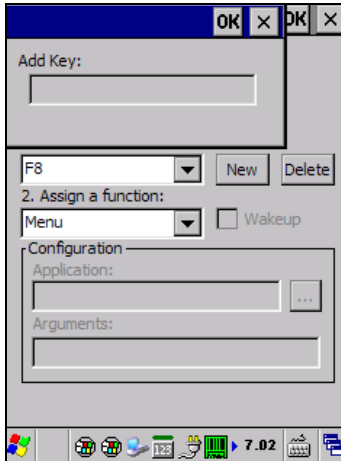

| COMMAND | DESCRIPTION |
|-----------|--|
| Enter Key | Enter the desired key combination in this text box to define a Button. |
| OK | Select/tap OK to add the specified Button. |
| X | Select/tap X to cancel the insertion. |



NOTE

Make sure you do not attempt to add a Button that is already defined.

2. Select/tap OK to save the new Button. If you select/tap “X”, the key will not be saved.

**CAUTION**

It is possible for the keyboard wedge to activate assigned Buttons using alphanumeric characters. Barcodes containing characters associated with assigned Buttons will trigger the action or application assigned to that Button.

Triggers

Triggers are special customizable buttons that can be assigned to the 'Bar Code' function to control scanner activation. In addition they can be set as wakeup buttons by checking the 'Wakeup box':

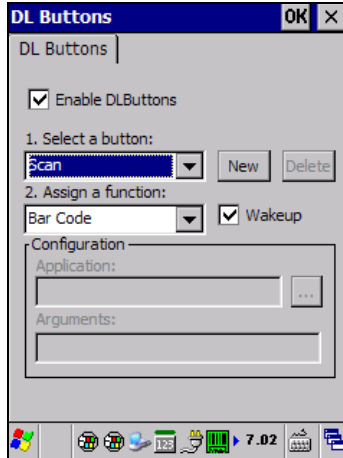

| TRIGGERS | DEFAULT CONFIGURATION | |
|-----------------|-----------------------|----------|
| | Assigned Function | Wake-up |
| Scan | Bar Code | Enabled |
| Right Side Scan | None | Disabled |
| Left Side Scan | None | Disabled |



NOTE

The 'Wakeup' functionality and 'Bar Code' function are not subordinate to the 'Enable DLButtons' check box, they are always applied.

Application Switcher

The application switcher provides the same functionality as the standard Windows® Alt+Tab function. This allows the user to switch between the various open applications.

The application switcher is a predefined function that could be assigned to any button in the DL Buttons tab (see par. 4.5.4.) When the assigned button is pressed, the dialog shown below will be displayed:

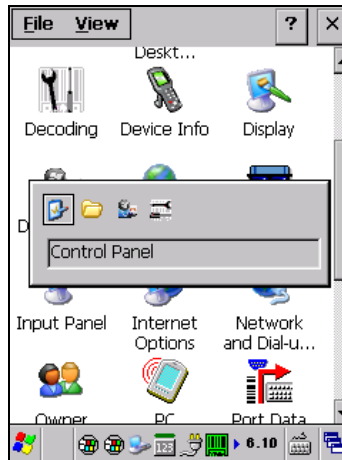

Press the assigned button to cycle through the running applications when the dialog is open. Press <Enter> to switch to the selected application or <Esc> to close the application switcher.

4.5.5 Registry

The Registry stores information that are necessary to configure the system for applications and hardware devices. The Registry also contains information that the operating system continually references to during operation.

From the Control Panel, double tap the “Registry Admin” icon. Two functions are available:

- Save Registry allows permanently saving the Windows configuration (example: custom configuration of screen desktop background color, or network adapter configuration) to non-volatile memory ('Save' button).
- Restore Default Registry allows restoring the initial factory default configuration ('Restore Default' button). After restoring the factory default configuration, you must perform a warm boot.

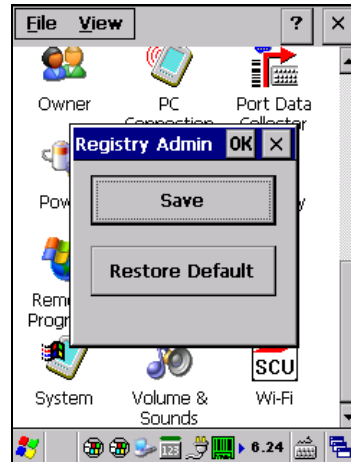

4.5.6 Files Admin

The Files Admin applet enables control of the permanence of files in the Windows CE System Folder.



Two functions are available:

Save Session: with this button all files will be permanently saved in the \Windows directory in non-volatile memory. This function guarantees the steady maintenance of every file produced during the current working session - even of sub-directories and relevant files - with the exception of the files belonging to the FLASH image. These current working session files will be backed-up in the \Backup\Windows directory.

At the next cold boot, the files previously saved in the \Backup\Windows directory will be restored to the Windows directory.

Safe Setup: with this button, the installation of software programs will be saved to non-volatile memory (Backup directory). Before doing this, it will be checked that the Backup directory has enough space to save the files. If the directory space is not enough, an error message will be shown and the program will exit the Safe Setup function.

Two activating procedures are available for Safe Setup:

- Select an installation file (for example, a .CAB cabinet file) from the Safe Setup mask.

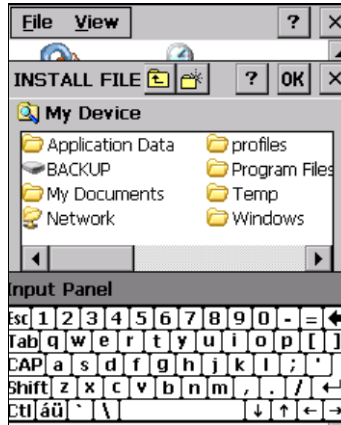

Safe Setup First Mask

Then select \Windows or a relevant sub-directory in the path box. Then, Safe Setup will recognize the new files and directories present in the \Windows directory, and will copy them to the \Backup\Windows directory. At the next cold boot, these files will be restored (see par.4.3.1).

- Simply skip the first mask either by closing it or by pressing the ESC key. When it closes, a new mask will pop up: it will enable any type of installation (even remote ones like ActiveSync® installations). Make sure the installation directory is \Windows or one of its sub-directories. After installation, tap OK: Safe Setup will save the new files in the \Backup\Windows directory.



4.5.7 Wireless Communications

Wireless networking has a customized control, Summit Client Utility (SCU), specific to the radio. There are two methods to access the SCU.

Start > Programs > Summit > SCU:

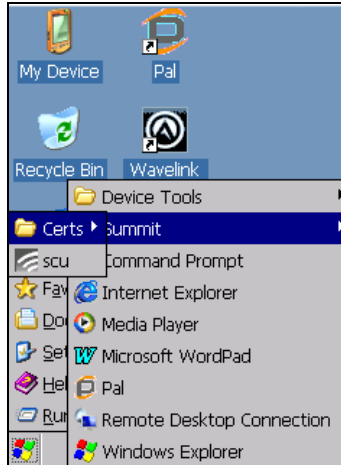

Or

From the Control Panel main window, double tap Wi-Fi to open the Summit Client Utility:



The SCU will open to the “Main” tab:

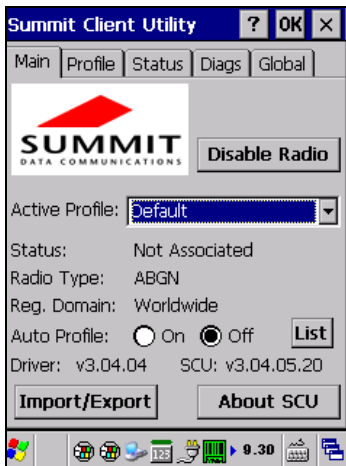

Summit Client Utility

1. To create a new profile, tap the "Profile" tab:

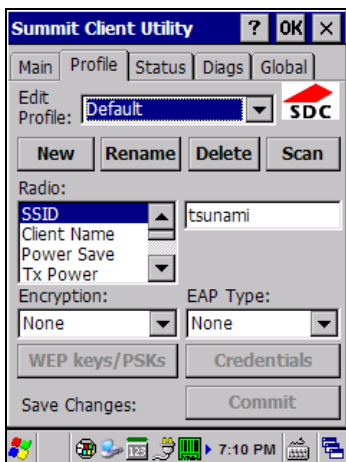

Information about the wireless network can be entered directly in the profile tab or by pressing “Scan” when the desired network ESSID is in range.

- At the "Scan" screen, select the desired SSID:

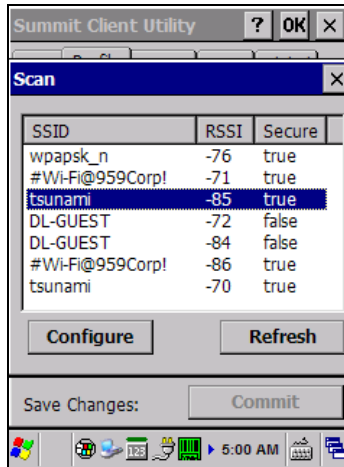

- Click the "Configure" button



- Follow the on-screen instructions to setup security parameters for your network. For more detailed settings specific to your installation please contact your wireless network administrator.

5. When finished, click “Commit” to save your settings.

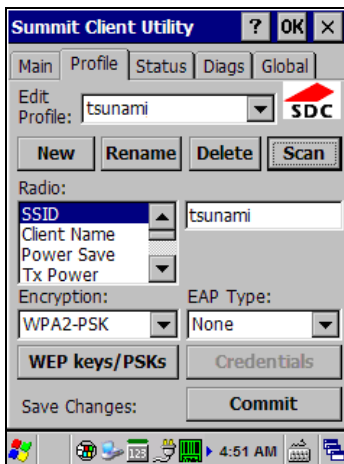

Return to the “Main” tab, if you have not previously selected “Commit” you will be prompted to save your changes.

At the “Main” tab select the profile you just created. If you used the “scan” button the desired profile will have the same name as the ESSID.

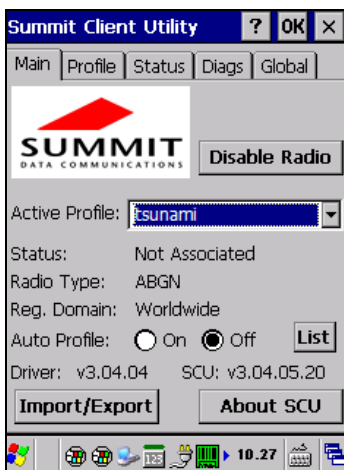

Use the “Status” tab to check connectivity to the network.

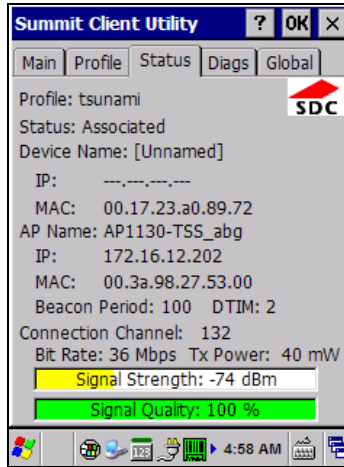

More detailed information about the applet for radio configuration can be found at <http://www.summitdata.com/SCU.htm>.

4.5.8 Stylus Calibration

When you experience an improper response from the touchscreen interface, you might need to recalibrate the device (i.e. when you attempt to select one item with the stylus, another item is erroneously selected).

To recalibrate the touch screen, complete the following steps:

1. From the Control Panel main window, double tap Stylus to open the “Stylus Properties” window:



- Adjust Double-Tap sensitivity if needed or desired:

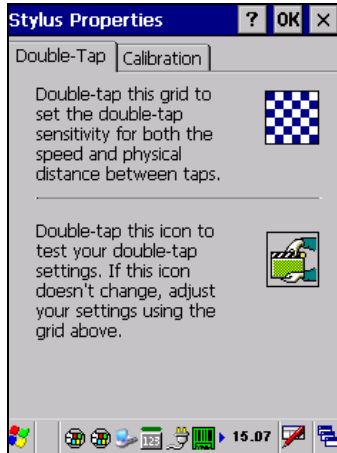

- Tap 'Calibration' to open the Calibration screen. Tap 'Recalibrate':



- Carefully press and briefly hold stylus on the center of the target. Repeat as the target moves around the screen. Press the Esc key to cancel the stylus calibration:

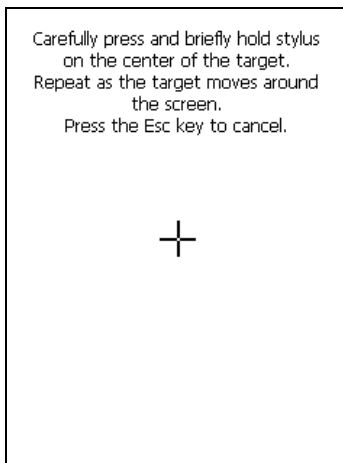

- Press the Enter key or tap the screen to accept the new calibration settings. Press the Esc key to keep the old settings.

New calibration settings are persistently saved in the Registry.

Startup Stylus Calibration

When starting the terminal, a stylus calibration screen comes up if valid calibration settings are not available. This happens in the following circumstances:

- At the first startup of the terminal.
- After restoring registry default settings using the applet **Registry Admin** and performing a warm boot.
- After a **Clean Boot**.
- After a **Firmware Update** (see section 4.8.3)

4.5.9 Audio Settings

There are two applets that control volume: Audio and Volume & Sounds.

Audio

From the control panel main window, double tap the 'Audio' icon:

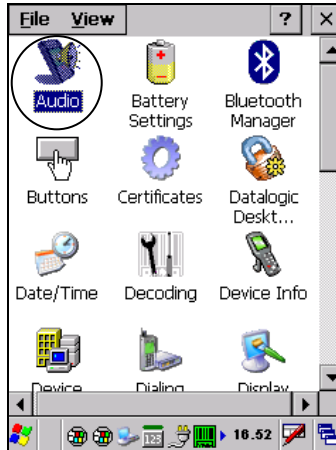

The Audio applet allows to set the recording volumes of the main microphone.

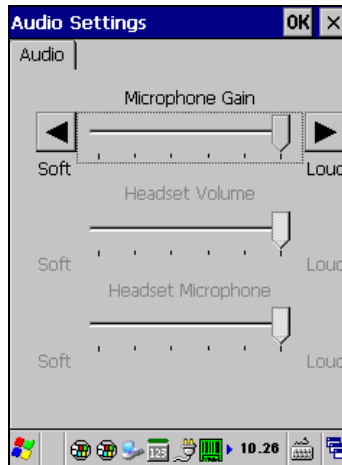

Audio Window

Volume & Sounds

From the control panel main window, double tap the Volume & Sounds icon:



The Volume & Sounds applet configures audio features of the rear speaker and appears as follows:

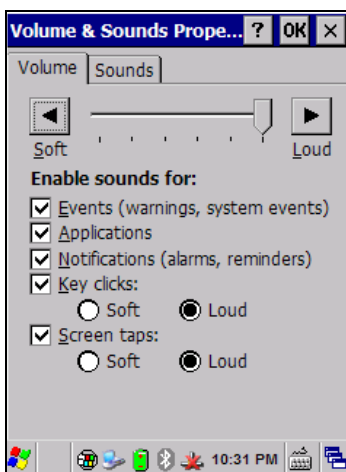

Volume & Sounds Window

4.6 CONNECTING TO OTHER COMPUTERS

There is more than one way to connect the Memor X3 to a host PC running Windows. Each requires specific connections in order to function properly.

4.6.1 Windows Mobile® Device Center

The desktop application Windows Mobile® Device Center gives you the ability to synchronize information between a desktop computer and your Memor X3. Synchronization compares the data on the Memor X3 with that on the desktop computer and updates both with the most recent information.

Windows Mobile® Device Center can be downloaded from Microsoft website www.microsoft.com. It is only compatible with Windows Vista and Windows 7; if you run Windows XP or earlier, you have to download Microsoft ActiveSync.

You can establish a connection to your Memor X3 through the following interfaces:

- USB either directly or through the Single Dock
- RS232 either directly or through the Single Dock
- Bluetooth® (see par. 4.6.2)

To establish a partnership between the Memor X3 and a host PC, start Windows Mobile® Device Center and follow the steps below:

1. Connect the Memor X3 to the host PC. Windows Mobile® Device Center configures itself and then opens.
2. On the license agreement screen, click Accept.
3. On the Windows Mobile Device Center's Home screen, click Set up your device.
4. Select the information types that you want to synchronize, then click Next.
5. Enter a device name and click Set Up.

When you finish the setup wizard, Windows Mobile Device Center synchronizes the mobile computer automatically.



NOTE

The Memor X3 running Windows CE does not come equipped with Microsoft Office Outlook or any other application that allows users to view contact, calendar, e-mail, or task data. Users can view files copied to the Memor X3 by WMDC's file synchronization feature.

4.6.2 Bluetooth® Manager Device Setup

Using the Memor X3 to connect to another device

To create a Bluetooth® pairing between your device and another device that has Bluetooth® capabilities, ensure that the two devices are turned on, discoverable, and within close range.

1. From the control panel, double tap the 'Bluetooth Manager' icon:



2. From the Bluetooth Manager control panel tap 'Connections'.



- tapping the button for the type of device you want (Printer, Serial or All) or tap Discovery > Discover to skip this step. The Memor X3 will search for Bluetooth® devices within range.

**NOTE**

If you attempt to set up a connection when the Bluetooth® radio is disabled, you will receive a message reminding you that the radio is turned off, and asking if you want to turn it on. Tap Yes if you need to enable the Bluetooth® radio.

- Once searching is complete, Bluetooth® device Profiles will be displayed in the Discovery tab. You can set up a connection to a device in the list by selecting the device and then tapping the 'Connect' button:







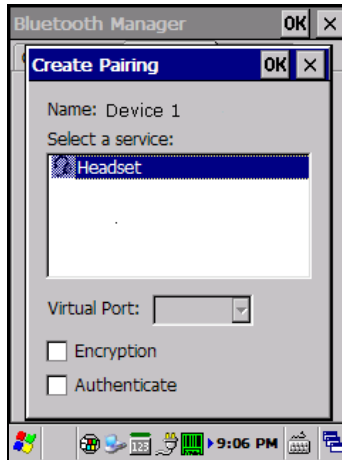





To create a pairing:

1. Select a service:



2. Configure any encryption, authentication, or virtual port options required by the service selected.

| Icon | Service |
|---|--|
|  | Dialup Networking |
|  | Printer |
|  | Object Push (OPP) Object Exchange (OBEX) |
|  | ActiveSync |
|  | Human Interface Device (HID) - Keyboard |
|  | Serial |
|  | Personal Area Network (PAN) |
|  | Modem |
|  | Headset |
|  | Handsfree |

Virtual Port allows you to specify the incoming port, which is used to communicate serially with an incoming device just as if it were a physical COM port. This option is available only if you have selected a Printer or Serial service.

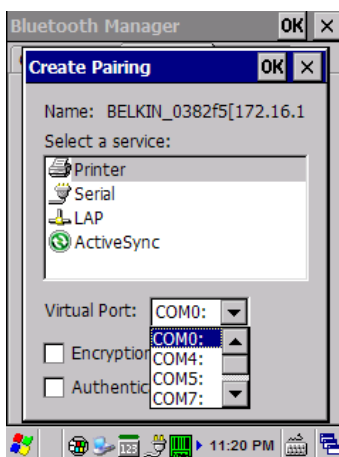

You can also select Encrypt or Authenticate from the Bluetooth® control panel to apply or modify those settings.

1. To require Authentication, check the checkbox, then tap OK.

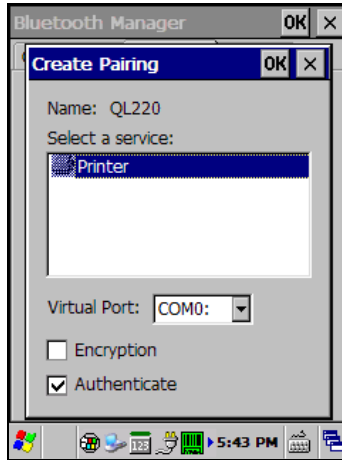

2. If required, the Authentication Request dialog will then open, requesting that you enter a PIN. Use the Input Panel or the keyboard to type the PIN.

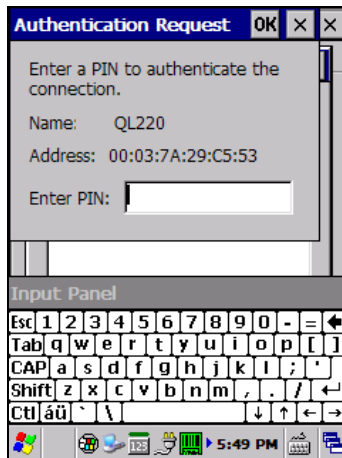

3. Tap OK to complete.

The dialog will also appear when an Authentication request is received from another device.

Once you have set up a pairing, you can view the settings by double-tapping its name from the Connections tab. Tap the arrow to change the Virtual Port, or Delete to remove the device pairing. Tap Sync to initiate a Sync (available only if the service is an ActiveSync connection).

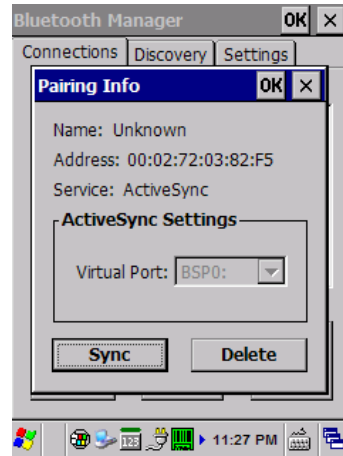
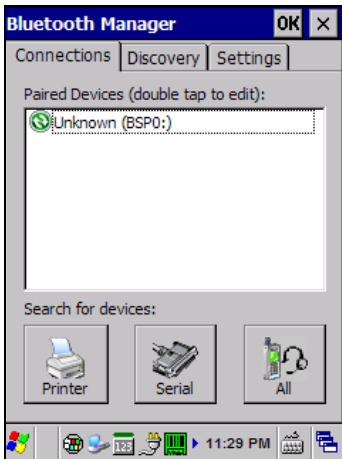

Using your device to connect to the Memor X3

Before turning on Bluetooth®, ensure that the two devices are within close range and that both Bluetooth-enabled devices are discoverable.

1. From the control panel main window, double tap the Bluetooth Manager icon to open the Bluetooth Manager control panel.

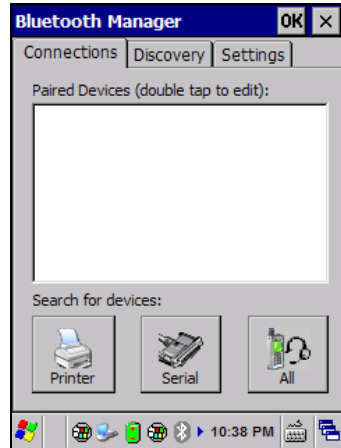

2. Tap Settings. The Settings tab allows you to enable or disable the Bluetooth® radio and specify settings for Incoming Connections.

- Select or clear the “Enable Bluetooth Radio” check box.
If you’re going to be attaching a serial device (i.e. a scanner) to the Memor X3, use the Port control to select a virtual COM port to use for the connection.

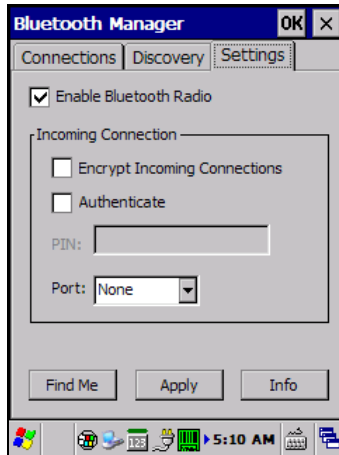

- Tap ‘Find Me’ if you want to make the Memor X3 discoverable to other Bluetooth® devices for 60 seconds, allowing them to set up a connection.

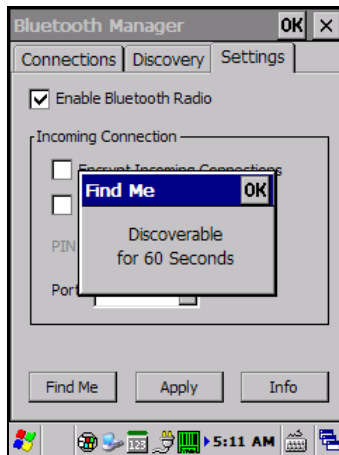
**NOTE**

By default, Bluetooth® is turned off. If you turn it on, and then turn off your device, Bluetooth® also turns off. When you turn on your device again, Bluetooth® turns on automatically.

4.6.3 FTP Server Setup

The Memor X3 Windows CE Operating System includes a sample File Transfer Protocol (FTP) server. FTP is used for copying files to and from remote computer systems over a network using TCP/IP. You can establish a connection to your Memor X3 using its FTP Server through the WLAN interface.

Proceed as follows:

1. Create a registry file (extension .reg) to setup and enable FTP Server communication. A simple example file for anonymous logon is given below:

```
REGEDIT4
```

```
[HKEY_LOCAL_MACHINE\Comm\FTPD]
"DefaultDir"="\\"
"AllowAnonymousUpload"=dword:00000001
"UseAuthentication"=dword:00000000
"BaseDir"="\\"
"IsEnabled"=dword:00000001
"LogSize"=dword:00001000
"DebugOutputMask"=dword:00000017
"DebugOutputChannels"=dword:00000002
"IdleTimeout"=dword:0000012c
"AllowAnonymous"=dword:00000001
"AllowAnonymousVroots"=dword:00000001
```

2. Copy this file to the Memor X3 using ActiveSync®.
3. Launch the .reg file from the Memor X3.
4. Perform a warm boot on the Memor X3.
5. From the PC > Explorer address bar (or running an FTP Client from the PC), enter the Memor X3 IP address.



NOTE

For more information on FTP Client/Server connections refer to the following web page:

<http://msdn2.microsoft.com/en-us/library/aa922316.aspx>

4.7 BACKUP DIRECTORY FILE MANAGEMENT

All of the Windows CE 6.0 system files reside in RAM (volatile memory) except for the Backup directory, which resides in FLASH (non-volatile memory). Therefore the contents of the Backup directory are persistent even if the mobile computer is re-booted or the battery pack is changed.

You can save your more important files that you don't want to lose due to mobile computer re-boot, in the Backup directory or create a sub-directory within Backup.

Even though the Windows Directory resides in RAM, it often contains files or sub-directories created by the user or by installation programs that you don't want to lose at re-boot. To keep these files persistent it is necessary to copy them to the directory `\Backup\Windows`. This directory doesn't exist originally (only Backup exists), and therefore it must be created. At the next cold boot, before activating the shell, Windows CE 6.0 will copy the contents including all sub-directories of `\Backup\Windows` to `\Windows`.

Likewise, to maintain files that must be run at Windows CE 6.0 startup, (i.e. `.exe`, `.lnk`, `.vb`, `.htm`, etc.), it is necessary to copy them to the directory `\Backup\Startup`. This directory does not exist originally (only Backup exists), and therefore it must be created. The application programs will be run after any type of re-boot (both software and cold boot).

As an alternative to the Safe Setup function, it is possible to copy the `.cab` files to the directory `\Backup\Cabfiles` (the `Cabfiles` sub-directory doesn't exist originally and must therefore be created) and perform a mobile computer cold boot to have the application installed. Once these files are copied to the directory `\Backup\Cabfiles`, the application will be run after each re-boot.

From the second cold boot on, a message may be displayed such as "<application name> is already installed. Re-install?". This message blocks the boot process. Press the [Enter] key to continue the system initialization.

4.8 DATALOGIC FIRMWARE UTILITY

The Datalogic devices are equipped with a field upgradeable firmware mechanism. Firmware updates are available on the Datalogic website:

<http://www.datalogic.com/eng/support-services/automatic-data-capture/downloads/software-utilities-sw-2.html>.

After you have downloaded the desired update, there are several ways you can update the firmware on your device.

- Use Wavelink Avalanche™ if you have multiple Datalogic devices to update. For more information refer to the dedicated section of the Wavelink website: <http://www.wavelink.com/Datalogic-device-downloads>.
- If Wavelink Avalanche™ is not available or you have only a few Datalogic devices to update, use the Datalogic Firmware Utility (DFU), described below, to install or update the firmware using an ActiveSync connection.

The following sections provide procedures for the retrieval and installation of the latest firmware image onto a Datalogic device.

4.8.1 Retrieving a Firmware Image Update

The following instructions use Internet Explorer to retrieve the latest firmware image.

1. Launch Internet Explorer on your PC and navigate to the Datalogic website.
2. Navigate to the Downloads section of the website.
3. Using the device selection fields, select the file you want to download, then click Save to begin copying the files to your local machine (or local network location).

4.8.2 Installing DFU on the Host PC

Datalogic Firmware Utility (DFU) provides administrators with a field upgrade mechanism. You must have Microsoft® ActiveSync (for Windows XP devices) or Windows Mobile® Device Center (for Windows 7 and Vista devices) already loaded and running on the host PC to use DFU. Refer to par. 4.6.1 for more information about Windows Mobile® Device Center.

**NOTE**

Prior to installing, you must remove any previous versions of DFU installed on the host PC.

To install the Datalogic Firmware Utility, complete the following steps on the PC:

1. Go to the Datalogic website and download the latest version of the Datalogic Firmware Utility. Unzip the file, then double-click to run `DFU_Setup.exe`.
2. Click OK to continue once you have removed previous versions of DFU.
3. The Welcome to DFU Setup Program screen opens.
 - Please exit all Windows applications before running this installer.
 - Click Next to continue the Setup.
4. Follow the onscreen instructions to complete the installation.

4.8.3 Updating the Firmware

After copying the firmware image to the host PC (see par. 4.10.1) and installing DFU (see par. 4.8.2), you can upgrade the firmware on your Datalogic device.



NOTE

The following steps require that you have already established an ActiveSync or Windows Mobile Device Center connection between the host computer and the Datalogic device.

1. Go to Start > Programs > Datalogic > DFU > Datalogic Firmware Utility.
2. Verify that ActiveSync is selected by clicking Communications > WMDC/ ActiveSync.
3. Click browse (...) and navigate to the location where you saved the firmware file for your terminal.

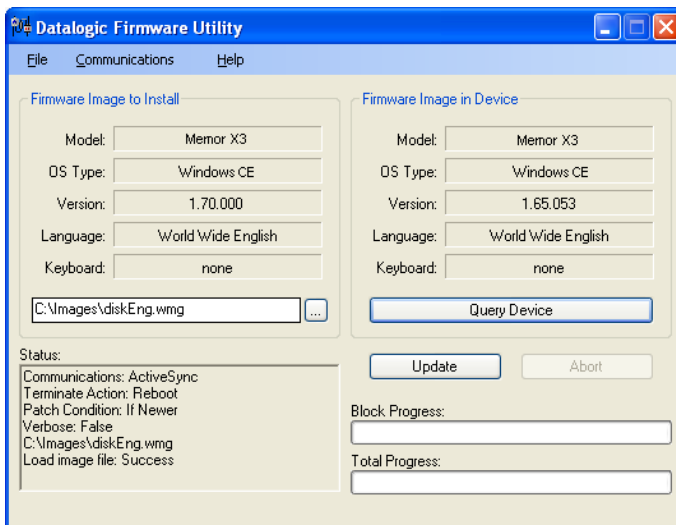

4. Select the firmware you want to apply and click Open.
5. Click Update.
6. DFU will compare the selected firmware image with the firmware already loaded on the device; if the image is compatible with the connected device, DFU will proceed to update the firmware image on your device.

To complete the firmware update DFU will automatically perform a warm reset of the device.

4.9 DATALOGIC CONFIGURATION UTILITY

Datalogic Configuration Utility (DCU) is a Datalogic Windows-based utility tool allowing the uploading, modifying and downloading of the configuration of a Datalogic device. Configuration settings include Scanner, Control Panel, and Datalogic Desktop Utility (DDU). The DCU installer is downloadable from the Datalogic website (<http://www.datalogic.com/eng/support-services/automatic-data-capture/downloads/software-utilities-sw-2.html>).

DCU functions in both direct (with an ActiveSync connection) and indirect (with Wavelink Avalanche™) modes.

In direct mode, connect a device through ActiveSync and then click on the Get from Device icon to receive the device's current configuration.

Once loaded, the Configuration Tree (on the left side of the window) is used to navigate the device's configuration. The right side of the window is a work area where the values of different parameters may be set for each branch of the configuration tree. Click on the parameter group branch to open it and inspect the parameters you wish to modify.

After altering the device's configuration, the new configuration can be sent to the terminal by clicking on the Send to Device icon.

Reference the Wavelink Avalanche™ documentation on the Wavelink website (www.wavelink.com/Datalogic-device-downloads) for a description of indirect mode for DCU, which will allow you to update the configuration of multiple devices simultaneously over Wi-Fi.

4.10 DATALOGIC DESKTOP UTILITY

Datalogic Desktop Utility (DDU) allows administrators to configure Windows® CE and Embedded Handheld devices to control individual user access. This includes the ability to:

- Prevent users from changing your device OS settings.
- Use Application Selector to replace desktop with a selection of authorized applications
- Internet Explorer access restriction, configuration and customized recovery mechanisms.

To open DDU for the first time, tap Start > Settings > Control Panel > or Start > Programs > Device tools > and then double tap the icon for “Datalogic Desktop Utility”.

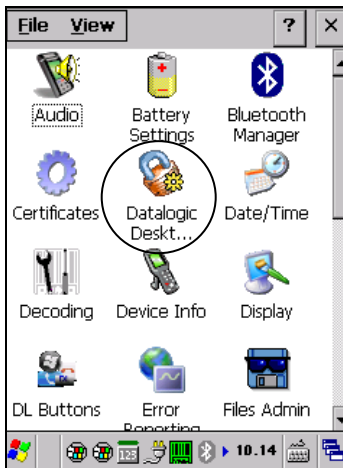

You can also open DDU by pressing the appropriate key shortcut. The default is “Alt + 6”.



NOTE

The key combination can be changed by using DL Buttons to redefine the association for specific keys (such as <F1>-<F10>). See par. 4.5.4 for more information.

4.10.1 Administrative Options (Admin tab)

When you open the DDU control panel, the “Admin” tab appears.



| COMMAND | DESCRIPTION |
|--------------------------|--|
| Enable Datalogic Desktop | Select/tap this checkbox to activate the DDU functions such as Windows Access Restrictions and Application Selector. |
| Enter Password | Enter a password in the text box. This allows the user to specify a password when this utility is launched. By default the password is “1234”. A password can consist of all standard keyboard characters. |
| Re-Enter Password | Carefully re-enter the password in the second text box. |
| Set Password | Select/tap “Set Password” to enable the password. To change or remove the password, enter a new value, re-enter the new value, and select/tap “Set Password”. |
| Set Defaults | Select/tap “Set Defaults” to reset the default values of all the functions on all the tabs. After you select this option, you will receive a prompt to verify this selection. |

Setting a Password

To set a password:

1. Enter a password in the field. This allows the user to specify a password when this utility is launched. By default the password is "1234".



NOTE

Be sure to record the Password for future reference.

2. Re-enter the password in the second field.
3. Select/tap "Set Password" to enable the password.
4. Select/tap "OK" to close the "Set Password Confirmation" dialog.



NOTE

You must select/tap "Set Password" prior to exiting DDU in order to store and activate your new password. It is not necessary to select "Enable Datalogic Desktop".



CAUTION

If you select/tap "Set Defaults" it will remove all custom settings and restore all the factory default settings, except a previously set password.

Changing a Password

To change to a new password:

1. Enter a new value in the "Enter Password field".
2. Re-enter the new value in the "Re-enter Password" field.
3. Select/tap "Set Password".

Removing a Password

To remove a password:

1. Enter blanks in both “Password” fields.
2. Select/tap “Set Password”.

Password Request Dialog Box

Once the password is set, the next time you open the “Datalogic Desktop Utility”, the DDU Password dialog box opens.

This dialog box will only open if a password was defined.

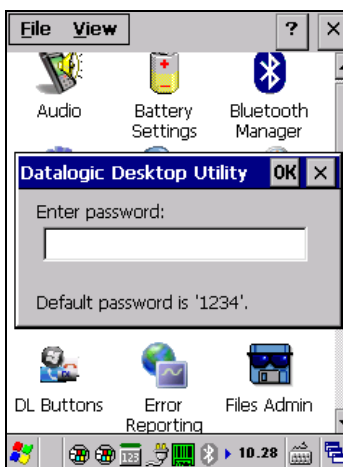

1. Type in your password using either the keypad on the unit, or using the stylus on the soft input panel (SIP).
If you enter an incorrect password, the system will prompt you to input the correct one.
2. Select/tap “OK” to verify the password. Or tap “X” to cancel.

4.10.2 Locked Web Browser Options (LockedWeb tab)

Tap the LockedWeb tab to access the Locked Web Browser Configuration.



NOTE

Locked Web Browser is not available in Memor X3 models supporting Windows CE Core



NOTE

Locked Web Browser is disabled by default. To enable, go to "Advanced settings" on the next page for more information.

For additional information about Locked Web Browser commands and metatags, see section 4.12, Locked Web Browser.

Error Page Redirection

Use the Error Redirection option to provide customized recovery from common errors. When an error occurs, the browser can redirect access to a specified error page with instructions on how to recover from the problem.

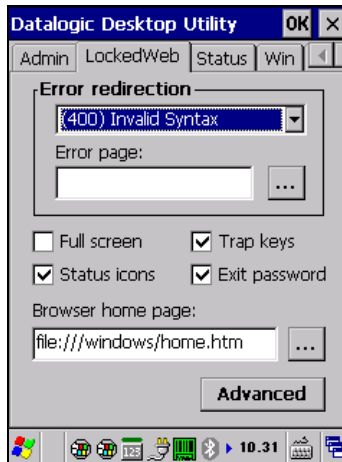

Locked Web Configuration Tab

| Error Redirection options | |
|----------------------------------|--|
| Error Type | The "Error Type" pull-down list displays available Error Types: (400) Invalid Syntax, (403) Request Forbidden, (404) Object Not Found, (406) No Response Format, (410) Page Doesn't Exist, (500) Internal Server Error, (501) Server Can't Do That, Generic Error, Network Disconnected |
| Error Page | Edit this textbox to associate a website or html file with the specified error. |
| Other options | |
| Full Screen | Set the web browser in full screen mode. |
| Status Icon | Enable or disable the status icons view (see par. 4.10.3). The status icons can be configured on the Status tab of DDU. |
| Trap Keys | When checked: <ul style="list-style-type: none"> – all key presses will be trapped by the Locked Web Browser to prevent the user from accessing unsafe parts of the system. For example, pressing Ctrl+O to Open a File will not work; – safe key presses (e.g. Alpha numeric) will still get processed by the Locked Web Browser as normal. For example entering a number in a text field on a web page; – DL Buttons keys will not work in the LockedWeb Browser; – all Locked Web Browser command keys will work (e.g. Ctrl+0 to exit). When unchecked: <ul style="list-style-type: none"> – all keys will be processed normally by the system and the browser; – DL Buttons keys will work normally; – all Locked Web Browser command keys will work (e.g. Ctrl+0 to exit). |
| Exit Password | When checked, a password will be required before the Locked Web Browser can exit. This password is different than the DDU exit password, with a default value of "0000", and can be changed in the "Advanced" settings. |
| Browser Home Page | This sets the Internet Explorer home page, regardless of the enable state of the Locked Web Browser. |
| Advanced | Pressing this button will launch a dialog used to enable Locked Web Browser and to configure Advanced settings. |

Advanced Settings



General Tab

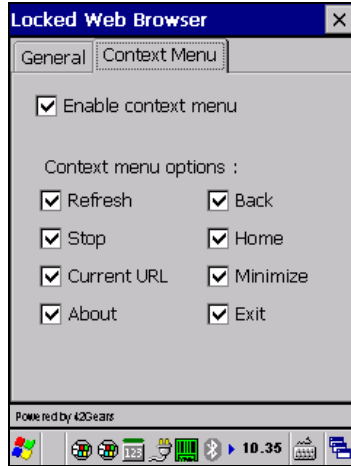

Context Menu

| Advanced Locked Web Browser options | |
|-------------------------------------|--|
| General | |
| Enable Locked Web Browser | When checked, enables the Locked Web Browser when Internet Explorer is launched. |
| Disable Cache | Prevents the browser from loading the local intranet page from cache instead of navigating to the "Network Disconnected" error redirection page. |

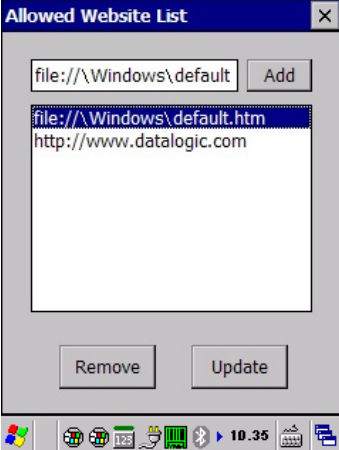
| Advanced Locked Web Browser options | |
|--|---|
| Allowed Website List | <p>Enables a “white list,” which restricts browsing only to files and URLs in the Allowed Website list (accessed by the “...” button). The following dialog appears:</p>  <p style="text-align: center;">Allowed Website List</p> <p>Click the “Add” button to add allowed URLs to the white list. Other sites will be restricted when the option is enabled. Domain names must be exactly specified.</p> |
| Change Exit Password | <p>Pressing this button brings up a dialog which allows the user to change the password required to exit the Locked Web Browser (when the “Exit password” option is selected on the LockedWeb tab in DDU).</p> |

| Advanced Locked Web Browser options | |
|--|---|
| Context Menu | |
| Enable Context Menu | Enables the context menu accessed by a touch screen press in the Locked Web Browser. |
| Refresh | Adds a “Refresh” item to the Locked Web Browser context menu. Selecting the “Refresh” item refreshes the web page. |
| Stop | Adds a “Stop” item to the Locked Web Browser context menu. Selecting during navigation stops the downloading of a page. |
| Current URL | Adds a “Current URL” item to the Locked Web Browser context menu. Selecting the item pops up a dialog displaying the URL for the current web page. |
| About | Adds an “About” item to the Locked Web Browser context menu. Selecting the “About” item pops up the “About” dialog. |
| Back | Adds a “Back” item to the Locked Web Browser context menu. Selecting the “Back” item performs a navigation to the previous page. |
| Home | Adds a “Home” item to the Locked Web Browser context menu. Selecting the “Home” item navigates to the IE home page. |
| Minimize | Adds a “Minimize” item to the Locked Web Browser context menu. Selecting the item minimizes the Locked Web Browser and allows access to other programs. |
| Exit | Adds an “Exit” item to the Locked Web Browser context menu. Selecting the item exits the Locked Web Browser with an optional password (set in the Locked Web Browser Advanced options). |

4.10.3 Status Icons Options (Status Tab)

Tap the “Status” tab to access the Status Icons option. You can configure the view of some status icons that are used in “LockedWeb” and in “Application Selector” to display the status of: Wi-Fi radio and battery.

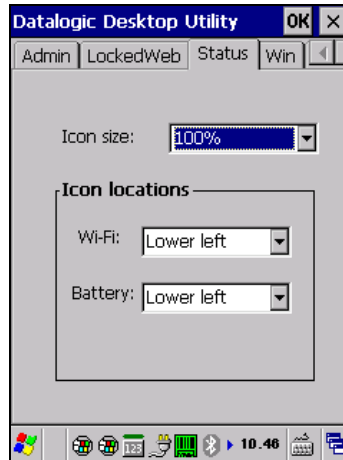

| Status Icons Options | |
|----------------------|--|
| Icon Size | Sets the status icons' size. |
| Icon Locations | Selects the preferred location for each status icon. |

4.10.4 Windows Controls

Select/tap the “Win” (Windows Controls) tab to access the Windows Controls option. Use Windows controls to allow or restrict access to Windows system functions.

You can disable normal Windows functions such as the taskbar, leaving nothing but a blank workspace. This allows applications to be run in full screen mode and prevents users from accidental or unauthorized use of the taskbar, Internet Explorer, and any other resident applications.

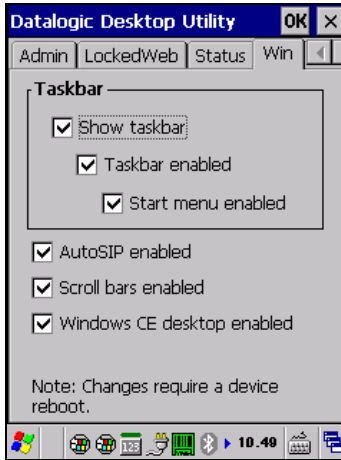

| WINDOWS CONTROLS | |
|--------------------|---|
| Show Taskbar | Select/tap “Show Taskbar” to specify whether the Taskbar is displayed or not |
| Taskbar Enabled | Select/tap “Taskbar Enabled” to specify whether the taskbar is accessible. This option is only available when the “Show Taskbar” is checked. |
| Start Menu Enabled | Select/tap “Start Menu Enabled” to specify whether the Start Menu is displayed or not. This option works only when “Task Bar Enabled” is checked. |
| AutoSIP Enabled | Enables the AutoSIP Windows feature. |

| WINDOWS CONTROLS | |
|----------------------------|--|
| Scroll Bars Enabled | This control only takes effect in Locked Web Browser. When checked, displays horizontal and vertical scroll bars to help view large web pages which do not fit the screen. When unchecked, scroll bars will not be present. |
| Windows CE Desktop Enabled | Windows CE Desktop Enabled specifies whether the desktop icons are accessible or not |

**NOTE**

Changes require a device reboot.

4.10.5 AppSelector Options (AppSelect tab)

Tap the Application Selector (“AppSelect” Tab) to edit, add, or delete applications for the application selector.

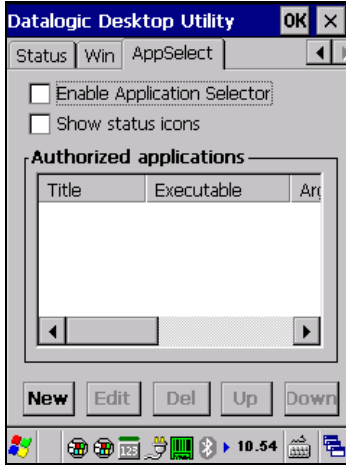

| Application Selector Options | |
|------------------------------|--|
| Enable Application Selector | Select/tap “Enable Application Selector” to enable/disable the application selector. When enabled, the Application Selector replaces the desktop and allows only authorized use of applications. |
| Show status icons | Enable or disable the status icons view (see par. 4.10.3). The status icons can be configured on the Status tab of DDU. |
| Authorized Applications | This is a list of applications that the user can access. |



| Application Selector Commands | |
|-------------------------------|---|
| New | Select/tap “New” to create a new application entry. |
| Edit | Select/tap “Edit” to edit the selected entry. |
| Del | Select/tap “Del” to delete the selected entry. |
| Up/Down | Select/tap “Up/Down” to move an entry up or down in the ListView. |

Add Applications

The “Add Application” dialog opens when you tap either “New” or “Edit”. From the “Add Application” dialog the administrator can configure and/or add/change a new application entry in the list.

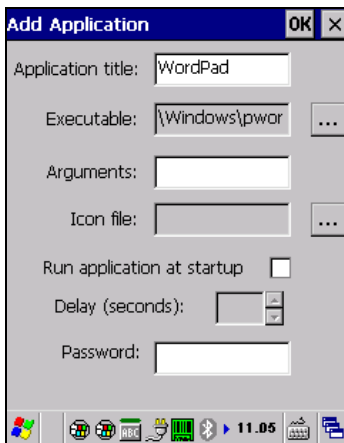
Applications with the “Run Application at Startup” option enabled will start automatically when the Application Selector starts up.



| COMMAND | DESCRIPTION |
|-------------------|--|
| Application Title | Type the name of the application in this textbox in the way you wish it to appear for the user. |
| Executable | Displays the path for the executable file which you want to run. |
| Browse | Select/tap  to browse for the desired executable file. The results of this search are placed in the “Executable” textbox. |
| Arguments | Type any command line arguments to be used when an application is executed. |
| Icon File | Displays the path/link to the desired icon file. |
| Browse | Select/tap  to browse for the desired icon file. The results of this search are placed in the “Icon File” textbox. |

| COMMAND | DESCRIPTION |
|----------------------------|---|
| Run Application at Startup | Select/tap this box to force this application to auto start when the Application Selector starts up. Applications will be started in the order listed in the authorized application list. |
| Delay | Enter a delay duration in seconds in the combo box. This option delays auto start of application(s) to allow drivers to load prior to starting applications. |
| OK | Select/tap "OK" to add/save changes. |
| X | Select/tap "X" to cancel the creation of this entry. |

4.11 APPSELECTOR (APPLICATION SELECTOR)

The Application Selector is an application that allows a device to run in kiosk mode. The administrator can choose for the user to have access to the desktop or not.

The Application Selector can replace the desktop and limit the user to the specified list of applications.

By default, the Application Selector comes with no applications preset.

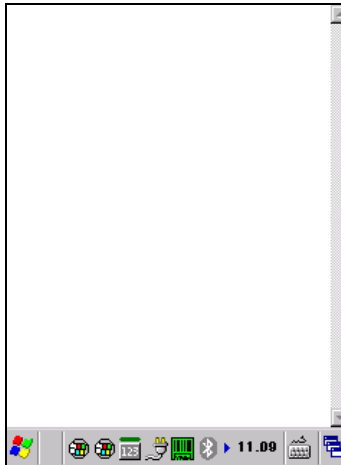

Figure 9 - Application Selector

The administrator can customize this list as shown in chapter 4.10.5.

To run an application, tap on its name.

Additionally, the page template can be modified to display a different background. Contact your Datalogic representative for more information on this feature.

To exit from Application Selector, press ALT + 6, uncheck the 'Enable Application Selector' check box on the AppSelect Tab and press OK to exit DDU.

4.12 LOCKED WEB BROWSER

The Locked Web Browser is a browser helper object for Internet Explorer. It allows an administrator to define a restricted internet usage environment. Once in the restricted environment, a password is required to exit. This means users can only access web applications and websites set by the administrator.



NOTE

Configuration is set up through the DDU control panel. See section 4.10.2 for more information.



In Full Screen mode, the status bar is displayed but with user interaction disabled.

While in these mode, the user can navigate within the web application by using the following keyboard shortcuts:

| | |
|---------|----------|
| Home | Ctrl + 7 |
| Refresh | Ctrl + 8 |
| Cancel | Ctrl + 9 |
| Exit | Ctrl + 0 |

For firmware versions 1.60 and greater, the following command line arguments are supported:

- /E optional parameter which allows for Exit without entering a password
- @URL optional parameter which specifies a URL to use as a home page.
- /C optional parameter which disables the ctrl keys (including the one to exit).

4.12.1 Locked Web Browser Special Metatags

General Metatag Comments

A metatag is a special HTML tag that stores information about a Web page but does not display in a Web browser. For example, metatags provide information such as the program used to create the page, a description of the page, and keywords relevant to the page.

As per the HTML specification, all metatags must be contained within a `<head> ... </head>` tag set.

Also, the head tag set must be complete within the first 15K of the web page.

The Datalogic Locked Web Browser defines some special metatags that allow the web application to interact with the device:

In particular, the special metatags allow it to:

- enable/disable scan engine triggers
- enable/disable specific symbologies in the scan engine
- easily assign a key press to a javascript function.

Metatag settings of trigger enable, symbology enable, or DL_Key assignments persist past the page in which they are loaded. The settings stay in effect until they are changed by another metatag.

Trigger Metatag

DL_Triggers – “Enable” or “Disable” all triggers

If the page contains this tag, the triggers are enable or disable depending on the “content=” value.

Example:

```
<meta http-equiv="DL_Triggers" content="Disable">
```

GetSerialNumber Meta-tag

DL_GetSerialNumber – Obtains the device serial number and sends it as an argument to a customer's javascript function.

Content – name of function to pass serial number to. Example:

```
<meta http-equiv="DL_GetSerialNumber" content="Javascript:CustomerFunction">
```

When a page with this metatag is loaded, the content should be a javascript function that receives one parameter, the serial number. An example would be function CustomerFunction(SerialNumber).

Reboot – Warm Boot Device Metatag

DL_Reboot – Warm boot device.

Content – “OnPageLoad” – Warm boot immediately upon page load.

Example:

```
<meta http-equiv="DL_Reboot" content=" OnPageLoad ">
```

Exit Metatag

DL_Exit – Exit the Locked Web Browser.

Content – “OnPageLoad” – Exit immediately upon page load. If “Exit password” has been enabled in the Locked Web Browser options, the Exit password will be required before exit.

Example:

```
<meta http-equiv="DL_Exit " content=" OnPageLoad ">
```

Decoding Metatags:

Each decoding metatag has a possible content of "Enable" or "Disable". The settings are valid for the entire page (enables/disables each symbology).

DL_Code_39
DL_Code_128
DL_Code_I25
DL_Code_S25
DL_Code_M25
DL_Code_CODABAR
DL_Code_93
DL_Code_UPCA
DL_Code_UPCE
DL_Code_EAN13
DL_Code_EAN8
DL_Code_MSI
DL_Code_MSR
DL_Code_GS1_14
DL_Code_GS1_LIMIT
DL_Code_GS1_EXP
DL_Code_PDF417
DL_Code_DATAMATIX
DL_Code_MAXICODE
DL_Code_TRIOPTIC
DL_Code_PHARMA39
DL_Code_RFID
DL_Code_MICROPDF417
DL_Code_COMPOSITE
DL_Code_QRCODE DL_Code_AZTEC
DL_Code_POSTAL

Examples:

```
<meta http-equiv="DL_Code_39" content="Disable">
```

```
<meta http-equiv="DL_Code_I25" content="Enable">
```

Key press Metatags

The key press metatags can be used to call JavaScript functions. They have the name structure: "DL_Key_xxx" where xxx is the VKey code.

Example:

```
<meta http-equiv="DL_Key_13" content="Javascript:CheckEnter();">
```

Assigning a key press via a DL_Key metatag overrides its use on the page. For instance, when entering data in a text box a character assigned as a DL_Key would not be entered in the text box. Instead, the javascript action would occur.

Refer to the Microsoft website to find the list of all the possible Vkey codes:

<http://msdn.microsoft.com/en-us/library/bb431750.aspx>

[http://msdn.microsoft.com/en-us/library/aa243025\(VS.60\).aspx](http://msdn.microsoft.com/en-us/library/aa243025(VS.60).aspx)



NOTE

Because DL_Keys persist past the page in which they were loaded, the DL_Clear metatag is provided to clear the settings on subsequent page loads.

Scanning Metatags

DL_Scan – Captures scan results and sends barcode/tag value to a javascript function on the web page.

If the "content=" value is a javascript function the device will be taken out of keyboard wedge mode and start listening for scan events. A scanned barcode/tag result will be used as an argument to that javascript function which is then invoked.

If the "content=" value is "Wedge" then the device will stop listening for scanned event and enter keyboard wedge mode.

If the "content=" value is "Disable" then the device will stop listening for scanned events but not enter keyboard wedge mode.

Example:

```
<meta http-equiv="DL_Scan" content="Javascript:ValidateInput()">
```

5 TECHNICAL FEATURES

5.1 TECHNICAL DATA

| PHYSICAL CHARACTERISTICS | |
|--------------------------------|--|
| DIMENSIONS (LxWxH) | 15.7 x 5.9 x 4.1 cm / 6.2 x 2.3 x 1.6 in |
| WEIGHT (DEPENDING ON MODEL) | 230 g / 7.76 oz (incl. 1430 mAh battery) 250 g / 8.81 oz (incl. 2300 mAh battery) |
| AUDIO | Rear Speaker for beeps and ringing tones Microphone and Front Speaker |
| LEDS | Three-color Good Read, Keyboard and Charging Status |
| DISPLAY | 65K Color TFT LCD with 320 x 240 pixel resolution (QVGA), with LED backlight and touch screen, antiglare and antiscratch protection |
| KEYBOARD | 25 Plastic Top - Backlit Keys + ON/OFF key |
| OPERATING TEMPERATURE* | -10° to +50 °C / 14 °F to +122 °F (for models with laser and 2D imager) -10 to +45°C / 14 °F to +113 °F (for models with CCD scan engine) |
| STORAGE TEMPERATURE | -20° to +70 °C / -4° to +158 °F |
| HUMIDITY** | 10 to 90% non-condensing for temperatures < 38 °C |
| DROP RESISTANCE*** | 1.2 M / 3.9 FT |
| ENVIROMENTAL SEALING | IP54 |
| ESD PROTECTION | 4 KV contact discharge, 8 KV air discharge |

* Battery should be charged at an ambient temperature between 0 - 36° C to achieve the maximum charging rate. Never charge the main device or spare batteries in a closed space where excessive heat can build up.

Close to the limits of the working temperature, some display and/or battery performance degradation may occur.

** Multiple rapid humidity and/or temperature variations may cause condensing.

*** Multiple drops can permanently damage the device.

| SYSTEM | |
|-----------------------------|--|
| OPERATING SYSTEM | Windows CE 6.0 Core Windows CE 6.0 Pro |
| MICROPROCESSOR | Marvell XScale™ PXA310 @ 624 MHz (Windows CE 6.0 Core) Marvell XScale™ PXA310 @ 806 MHz (Windows CE 6.0 Pro) |
| SYSTEM RAM MEMORY | 128 MB (Windows CE 6.0 Core) 256 MB (Windows CE 6.0 Pro) |
| SYSTEM FLASH MEMORY | 512 MB |
| POWER SUPPLY* | |
| DC Supply | 5 V ± 5% |
| Battery Pack | 1 cell Ion 1420 mAh@3.7 V (nominal) Alternatively 2 cell Li-Pol or Li-Ion 2300 mAh@3.7 V (nominal) |
| Internal Backup Battery | Rechargeable Ni-MH 30 mAh (2 x 15 mAh cells) |
| COMMUNICATIONS | |
| INTERFACES | Communication connector: Integrated RS232 up to 115.2 Kbps, USB 1.1 Client MicroUSB connector: USB 1.1 Client, USB 1.1 Host |
| LOCAL AREA NETWORK (LAN) | Summit IEEE 802.11abgn Frequency range: Country dependent, typically 2.4 and 5.2 GHz CCX v4 Security |
| PERSONAL AREA NETWORK (PAN) | Bluetooth® IEEE 802.15, Class 2, Version 2.1 |

* Use only DL approved battery packs power adapters.

| READING OPTIONS | |
|------------------------------|--|
| LASER CHARACTERISTICS | |
| SCANNING BIDIRECTIONAL | RATE 104 ± 12 scan/sec |
| OPTICAL RESOLUTION | 0.10 mm / 4 mils |
| SKEW ANGLE | ± 50° |
| PITCH ANGLE | ± 65° |
| LASER READER | VLD, wavelength 630~680 nm |
| BAR CODES | UPC A, UPC E, EAN 8, EAN 13, Code 39, Code 39 Full ASCII, Code 32, Interleaved 2 of 5, Industrial 2 of 5, Matrix 2 of 5, Code 128, EAN 128, Codabar, MSI, Plessey, Code 93, Code 11, GS1 Databar |
| LASER CLASSIFICATION | Laser: Class 2 Safety class EN 60825-1:2001 |
| LED CLASSIFICATION | Led (Green Spot): Class 1 |

| READING OPTIONS | |
|-------------------------------|---|
| IMAGER CHARACTERISTICS | |
| SCANNING RATE | 60 frames/sec |
| OPTICAL RESOLUTION | 0.13 mm / 5 mils |
| AIMING LASER | VLD, wavelength 645~665 nm |
| BAR CODES | Decoded barcodes 1D: UPC A, UPC E, EAN 8, EAN 13, Interleaved 2 of 5, Codabar, Code 11, Code 39, Code 39 Full ASCII, Code 93, Code 128, EAN 128, GS1 Databar, MSI, Matrix 2 of 5, Standard 2 of 5, Plessey |
| | Decoded barcodes 2D: PDF417, DataMatrix, QR, MicroPDF, RSS, Maxicode, Aztec |
| | Postal codes: PostNet, Planet, UK Postal, Japan Postal, Australia Postal, Ducth Postal, USPS, UPU, UK Check TX, US Check TX |
| LASER CLASSIFICATION | Laser: Class 2 Safety class: N 60825-1:2001 |
| LED CLASSIFICATION | Led (Illuminator): Class 1M |
| ILLUMINATION SYSTEM | LEDs 620~630 nm |

| READING OPTIONS | |
|--------------------------------------|---|
| LINEAR IMAGER CHARACTERISTICS | |
| SCANNING RATE | 50 scan/sec nominal |
| OPTICAL RESOLUTION | 5 mil (minimum readable bar code module size) |
| DEPTH OF FIELD | See reading diagrams |
| SKEW ANGLE | $\pm 50^\circ$ |
| PITCH ANGLE | $\pm 65^\circ$ |
| BAR CODES | GS1 DataBar family, EAN/UPC, Code 39, 2/5 Codes, MSI, Codabar, Code 128, GS1-128, Code 93, Code 11, Pharmacode 39, Trioptic |
| LASER CLASSIFICATION | Laser: Class 2 Safety class: N 60825-1:2001 |
| LED CLASSIFICATION | Led (Illuminator): Class 1M |
| ILLUMINATION SYSTEM | LEDs 620~630 nm |

5.2 READING DIAGRAMS

Memor X3 SE950-DL

Typical Reading Diagram – measured from the device nose (10° skew angle)

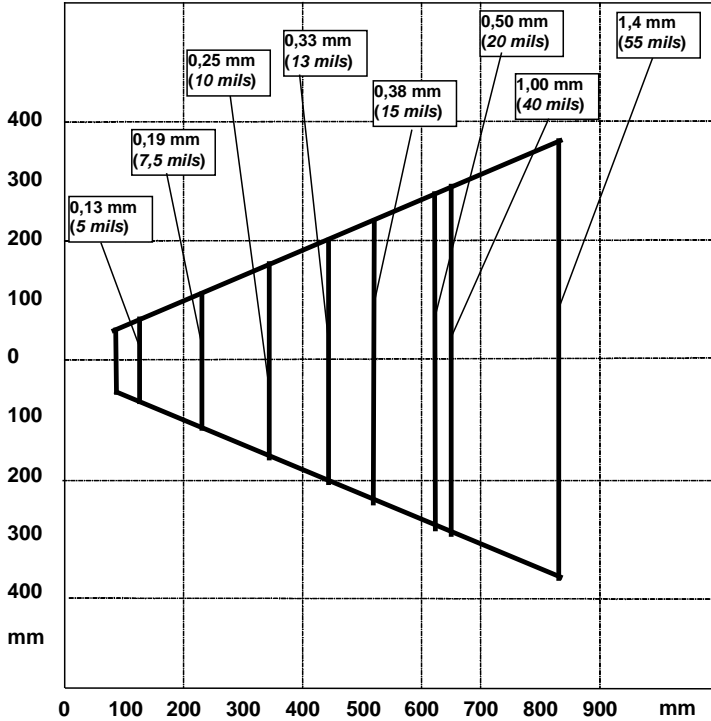

Memor X3 SE4500-DL

Typical Reading Diagram – Measured from the device nose (10° skew angle)

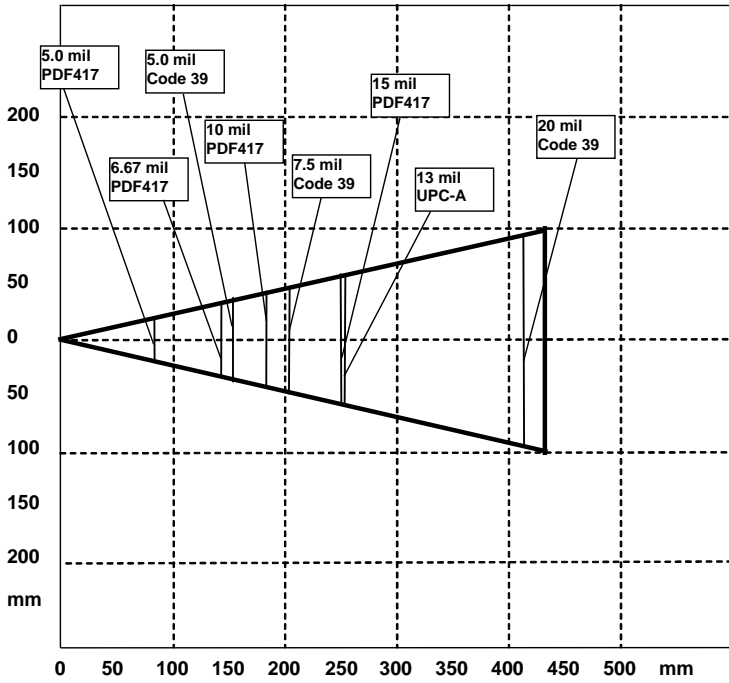

Memor X3 CCD Linear Imager

Typical Reading Diagram – Measured from the device nose (10° skew angle)

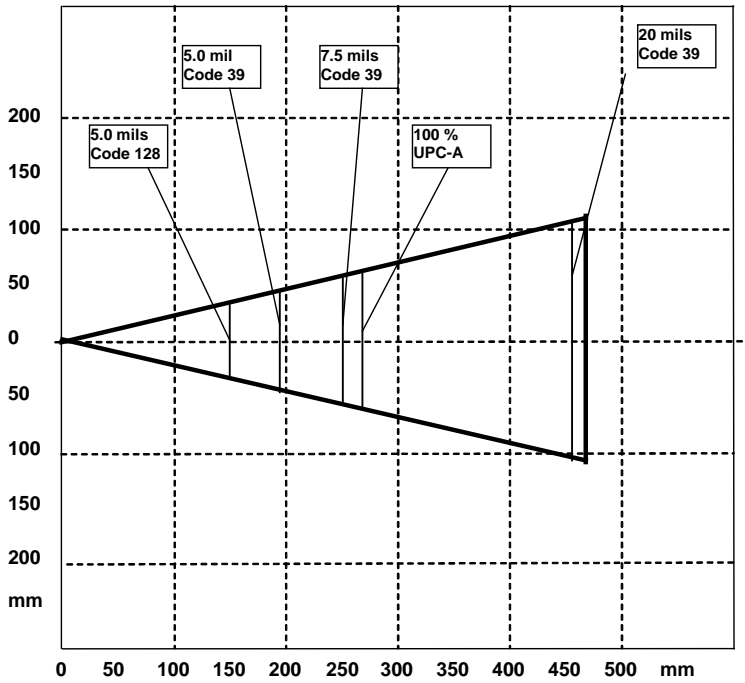

6 TEST CODES

High Density Codes

0.25 mm (10 mils)

Code 39



17162

2/5 Interleaved



0123456784

Code 128



test

EAN 13



8 012345 000012

EAN 8



6450 9723

Medium Density Codes

0.38 mm (15 mils)

Code 39



17162

Interleaved 2/5



0123456784

Code 128



test

EAN 13

100%



8 012345 000012

EAN 8

100%



6450 9723

Low Density Codes

0.50 mm (20 mils)

Code 39



17162

Interleaved 2/5



0123456784

Code 128



test

EAN 13

120%



8 012345 000012

EAN 8

120%



6450 9723

2D Codes

Datamatrix ECC200



Example

Inverse
Datamatrix ECC200



Example

REGULATORY INFORMATION



NOTE

Read this manual carefully before performing any type of connection to the Memor X3 mobile computer.

The user is responsible for any damage caused by incorrect use of the equipment or by inobservance of the indication supplied in this manual.

GENERAL SAFETY RULES

- Use only the components supplied by the manufacturer for the specific Memor X3 being used.
- Do not attempt to disassemble the Memor X3 mobile computer, as it does not contain parts that can be repaired by the user. Any tampering will invalidate the warranty.
- When replacing the battery pack or at the end of the operative life of the Memor X3 mobile computer, disposal must be performed in compliance with the laws in force in your jurisdiction.
- Before using the devices and the battery packs, read chap. 2.
- Do not submerge the Memor X3 in liquid products.
- For further information, refer to this manual and to the Datalogic web site: www.datalogic.com.

POWER SUPPLY

This device is intended to be connected to a UL Listed/CSA Certified computer which supplies power directly to the Memor X3 or else be supplied by a UL Listed/CSA Certified Power Unit marked “Class 2” or LPS power source rated 5 V, 3.0 A, which supplies power directly to the Memor X3 via the power connector of the cable.

The package includes three international plug adapters. The adapters must be plugged in the power supply before the power supply itself is plugged on the wall outlet.

LASER SAFETY

This information applies to both laser models and the Memor X3 Imager Aiming System. The following information applies to both laser models and the Memor X3 Imager Aiming System.

The laser light is visible to the human eye and is emitted from the window indicated in the figure below.

LASER LIGHT - DO NOT STARE INTO BEAM; CLASS 2 LASER PRODUCT
MAX OUTPUT RADIATION 1 mW; COMPLIANT WITH EN 60825-1 (2014)m.



NOTE

The artwork below may be only a draft. Please refer to the label attached to the product for information about certification marks..

Laser output window



MOD (型号):MEMORX3
TYPE:0000LI-2N0-COU1
产品名称: 便携式数据终端
MFD: June 2013
Datalogic ADC S.r.l, via S.

P / N : 944250001



S/N: P13F00001

| I | D | F | E |
|--|--|---|--|
| <p>La luce laser è visibile all'occhio umano e viene emessa dalla finestra indicata nella figura.</p> | <p>Die Laserstrahlung ist für das menschliche Auge sichtbar und wird am Strahlaustrittsfenster ausgesendet (siehe Bild).</p> | <p>Le rayon laser est visible à l'oeil nu et il est émis par la fenêtre désignée sur l'illustration dans la figure.</p> | <p>La luz láser es visible al ojo humano y es emitida por la ventana indicada en la figura.</p> |
| <p>LUCE LASER NON FISSARE IL FASCIO APPARECCHIO LASER DI CLASSE 2 MASSIMA POTENZA DI USCITA: 1 mW LUNGHEZZA D'ONDA EMESSA: 630-680 nm CONFORME A EN 60825-1 (2014)</p> | <p>LASERSTRAHLUNG NICHT IN DER STRAHL BLINKEN PRODUKT DER LASERKLASSE 2 MAXIMALE AUSGANGLEISTUNG: 1 mW WELLENLÄNGE: 630-680 nm ENTSPR. EN 60825-1 (2014)</p> | <p>RAYON LASER EVITER DE REGARDER LE RAYON APPAREIL LASER DE CLASSE 2 MAXIMUM PUISSANCE DE SORTIE: 1 mW LONGUER D'ONDE EMISE: 630-680 nm CONFORME A EN 60825-1 (2014)</p> | <p>RAYO LÁSER NO MIRAR FIJO EL RAYO APARATO LÁSER DE CLASE 2 MÁXIMA POTENCIA DE SALIDA: 1 mW LONGITUD DE ONDA EMITIDA: 630-680 nm CONFORME A EN 60825-1 (2014)</p> |

ENGLISH

The following information is provided to comply with the rules imposed by international authorities and refers to the correct use of your mobile computer.

STANDARD LASER SAFETY REGULATIONS

This product conforms to the applicable requirements of both CDRH 21 CFR 1040 and EN 60825-1 at the date of manufacture.

For installation, use and maintenance, it is not necessary to open the device.



CAUTION

Do not attempt to open or otherwise service any components in the optics cavity. Opening or servicing any part of the optics cavity by unauthorized personnel may violate laser safety regulations. The optics system is a factory only repair item.



CAUTION

Use of controls or adjustments or performance of procedures other than those specified herein may result in exposure to hazardous visible laser light.

The product utilizes a low-power laser diode. Although staring directly at the laser beam momentarily causes no known biological damage, avoid staring at the beam as one would with any very strong light source, such as the sun. Avoid shining laser light into any person's eye, even through reflective surfaces such as mirrors, etc.



CAUTION

Use of optical systems with the scanner will increase eye hazard. Optical instruments include binoculars, microscopes, eye glasses and magnifying glasses.

ITALIANO

Le seguenti informazioni vengono fornite dietro direttive delle autorità internazionali e si riferiscono all'uso corretto del terminale.

NORMATIVE STANDARD PER LA SICUREZZA LASER

Questo prodotto risulta conforme alle normative vigenti sulla sicurezza laser alla data di produzione: CDRH 21 CFR 1040 e EN 60825-1.

Non si rende mai necessario aprire l'apparecchio per motivi di installazione, utilizzo o manutenzione.



ATTENZIONE

Non tentare di accedere allo scomparto contenete i componenti ottici o di farne la manutenzione.

L'apertura dello scomparto, o la manutenzione di qualsiasi parte ottica da parte di personale non autorizzato, potrebbe violare le norme della sicurezza. Il sistema ottico può essere riparato solamente alla fabbrica.



ATTENZIONE

L'utilizzo di procedure o regolazioni differenti da quelle descritte nella documentazione può provocare un'esposizione pericolosa a luce laser visibile.

Il prodotto utilizza un diodo laser a bassa potenza. Sebbene non siano noti danni riportati dall'occhio umano in seguito ad una esposizione di breve durata, evitare di fissare il raggio laser così come si eviterebbe qualsiasi altra sorgente di luminosità intensa, ad esempio il sole. Evitare inoltre di dirigere il raggio laser negli occhi di un osservatore, anche attraverso superfici riflettenti come gli specchi.



ATTENZIONE

L'uso di strumenti ottici assieme allo scanner può aumentare il pericolo di danno agli occhi. Tali strumenti ottici includono cannocchiali, microscopi, occhiali e lenti di ingrandimento.

DEUTSCH

Die folgenden Informationen stimmen mit den Sicherheitshinweisen überein, die von internationalen Behörden auferlegt wurden, und sie beziehen sich auf den korrekten Gebrauch vom Terminal.

NORM FÜR DIE LASERSICHERHEIT

Dies Produkt entspricht am Tag der Herstellung den gültigen EN 60825-1 und CDRH 21 CFR 1040 Normen für die Lasersicherheit.

Es ist nicht notwendig, das Gerät wegen Betrieb oder Installations-, und Wartungs-Arbeiten zu öffnen.



ACHTUNG

Unter keinen Umständen darf versucht werden, die Komponenten im Optikhohlraum zu öffnen oder auf irgendwelche andere Weise zu warten. Das Öffnen bzw. Warten der Komponenten im Optikhohlraum durch unbefugtes Personal verstößt gegen die Laser-Sicherheitsbestimmungen. Das Optiksystem darf nur werkseitig repariert werden.



ACHTUNG

Jegliche Änderungen am Gerät sowie Vorgehensweisen, die nicht in dieser Betriebsanleitung beschrieben werden, können ein gefährliches Laserlicht verursachen.

Der Produkt benutzt eine Laserdiode. Obwohl zur Zeit keine Augenschäden von kurzen Einstrahlungen bekannt sind, sollten Sie es vermeiden für längere Zeit in den Laserstrahl zu schauen, genauso wenig wie in starke Lichtquellen (z.B. die Sonne). Vermeiden Sie es, den Laserstrahl weder gegen die Augen eines Beobachters, noch gegen reflektierende Oberflächen zu richten.



ACHTUNG

Die Verwendung von Optiksystemen mit diesem Scanner erhöht die Gefahr einer Augenbeschädigung. Zu optischen Instrumenten gehören unter anderem Ferngläser, Mikroskope, Brillen und Vergrößerungsgläser.

FRANÇAIS

Les informations suivantes sont fournies selon les règles fixées par les autorités internationales et se réfèrent à une correcte utilisation du terminal.

NORMES DE SECURITE LASER

Ce produit est conforme aux normes de sécurité laser en vigueur à sa date de fabrication: CDRH 21 CFR 1040 s et EN 60825-1.

Il n'est pas nécessaire d'ouvrir l'appareil pour l'installation, l'utilisation ou l'entretien.



ATTENTION

Ne pas essayer d'ouvrir ou de réparer les composants de la cavité optique. L'ouverture de la cavité optique ou la réparation de ses composants par une personne non qualifiée peut entraîner le nonrespect des règles de sécurité relatives au laser. Le système optique ne peut être réparé qu'en usine.



ATTENTION

L'utilisation de procédures ou réglages différents de ceux donnés ici peut entraîner une dangereuse exposition à lumière laser visible.

Le produit utilise une diode laser. Aucun dommage aux yeux humains n'a été constaté à la suite d'une exposition au rayon laser. Eviter de regarder fixement le rayon, comme toute autre source lumineuse intense telle que le soleil. Eviter aussi de diriger le rayon vers les yeux d'un observateur, même à travers des surfaces réfléchissantes (miroirs, par exemple).



ATTENTION

L'utilisation d'instruments optiques avec le scanneur augmente le danger pour les yeux. Les instruments optiques comprennent les jumelles, les microscopes, les lunettes et les verres grossissants.

ESPAÑOL

Las informaciones siguientes son presentadas en conformidad con las disposiciones de las autoridades internacionales y se refieren al uso correcto del terminal.

NORMATIVAS ESTÁNDAR PARA LA SEGURIDAD LÁSER

Este aparato resulta conforme a las normativas vigentes de seguridad láser a la fecha de producción: CDRH 21 CFR 1040 y EN 60825-1.

No es necesario abrir el aparato para la instalación, la utilización o la manutención.



ATENCIÓN

No intente abrir o de ninguna manera dar servicio a ninguno de los componentes del receptáculo óptico. Abrir o dar servicio a las piezas del receptáculo óptico por parte del personal no autorizado podría ser una violación a los reglamentos de seguridad. El sistema óptico se puede reparar en la fábrica solamente.



ATENCIÓN

La utilización de procedimientos o regulaciones diferentes de aquellas descritas en la documentación puede causar una exposición peligrosa a la luz láser visible.

El aparato utiliza un diodo láser a baja potencia. No son notorios daños a los ojos humanos a consecuencia de una exposición de corta duración. Eviten de mirar fijo el rayo láser así como evitarían cualquiera otra fuente de luminosidad intensa, por ejemplo el sol. Además, eviten de dirigir el rayo láser hacia los ojos de un observador, también a través de superficies reflectantes como los espejos.



ATENCIÓN

El uso de sistemas ópticos con el escáner aumentará el riesgo de daños oculares. Los instrumentos ópticos incluyen binoculares, microscopios, lentes y lupas.

LED CLASS

LED illuminator integrated in the Memor X3 models with imager engine are compliant with exempt risk group requirements according to EN62471:2008 and IEC62471:2006.

CANADIAN STATEMENT

Ne pas regarder le faisceau.

Attention classe 2 lumière laser en cas d'ouverture éviter l'exposition - lumière est émise de la ouverture.

Ce produit est conforme au sous-chapitre J de CFR 21.

Rayonnement laser – ne pas regarder dans le faisceau – ne par regarder avec instrumentation optique - appareil à laser de classe 2 – emission maximale de 1mw – longueur d'onde emise 630 - 680nm – selon EN 60825-1:2007.

MARKING AND EUROPEAN ECONOMIC AREA (EEA)



In radio systems configured with mobile computers and access points, the frequencies to be used must be allowed by the spectrum authorities of the specific country in which the installation takes place. Be absolutely sure that the system frequencies are correctly set to be compliant with the spectrum requirements of the country. The Radio modules used in this product automatically adapt to the frequencies set by the system and do not require any parameter settings.

Requirements in AT/BE/BG/CZ/DK/EE/FR/DE/IS/IE/IT/EL/ES/CY/ LV/LI/LT/LU/HU/MT/NL/NO/PL/PT/RO/SI/SK/TR/FI/SE/CH/UK/ HR.5150MHz~5350MHz is for indoor use only.

CE (European Union) and restrictions on Wi-Fi

Notice: This device can be used in all the countries of Europe. Limitations in 5 GHz band: Pursuant to article 10 (10) of Directive 2014/53/EU, it indicated that this radio equipment will be subject to certain restrictions when it is used in the following countries: Belgium (BE), Bulgaria (BG), Czech (CZ), Denmark (DK), Germany (DE), Estonia (EE), Ireland (IE), Greece (EL), Spain (ES), France (FR), Croatia (HR), Italy (IT), Cyprus (CY), Latvia (LV), Lithuania (LT), Luxembourg (LU), Hungary (HU), Malta (MT) Netherlands (NL), Austria (AT), Poland (PL), Portugal (PT), Romania (RO), Slovenia (SI), Slovakia (SK), Finland (FI) Sweden (SE), United Kingdom (UK), Turkey (TR), Norway (NO), Switzerland (CH), Iceland (IS), Liechtenstein (LI). The WLAN feature of this device is restricted to indoor use when operating in the frequency range between 5150 and 5350 MHz.

STATEMENT OF COMPLIANCE

The full text of the EU declaration of conformity is available at the following internet address: www.datalogic.com.

STATEMENT OF COMPLIANCE

| | |
|----|---|
| BG | С настоящото Datalogic S.r.l. декларира, че този тип радиосъоръжение SKORPIO X3 е в съответствие с Директива 2014/53/ ЕС. Цялостният текст на ЕС декларацията за съответствие може да се намери на следния интернет адрес: www.datalogic.com . |
| ES | Por la presente, Datalogic S.r.l. declara que el tipo de equipo radioeléctrico SKORPIO X3 es conforme con la Directiva 2014/53/UE. El texto completo de la declaración UE de conformidad está disponible en la dirección Internet siguiente: www.datalogic.com . |

| | |
|----|---|
| CS | Tímto Datalogic S.r.l. prohlašuje, že typ rádiového zařízení SKORPIO X3 je v souladu se směrnicí 2014/53/EU. Úplné znění EU prohlášení o shodě je k dispozici na této internetové adrese: www.datalogic.com . |
| DE | Hermed erklærer Datalogic S.r.l., at radioudstyrstypen SKORPIO X3 er i overensstemmelse med direktiv 2014/53/EU. EU-overensstemmelseserklæringens fulde tekst kan findes på følgende internetadresse: www.datalogic.com . |
| ET | Käesolevaga deklareerib Datalogic S.r.l., et käesolev raadioseadme tüüp SKORPIO X3 vastab direktiivi 2014/53/EL nõuetele. Eli vastavusdeklaratsiooni täielik tekst on kättesaadav järgmisel internetiaadressil: www.datalogic.com . |
| EL | Με την παρούσα ο/η Datalogic S.r.l., δηλώνει ότι ο ραδιοεξοπλισμός SKORPIO X3 πληροί την οδηγία 2014/53/ΕΕ. Το πλήρες κείμενο της δήλωσης συμμόρφωσης ΕΕ διατίθεται στην ακόλουθη ιστοσελίδα στο διαδίκτυο: www.datalogic.com . |
| EN | Hereby, Datalogic S.r.l. declares that the radio equipment type MEMOR X3 is in compliance with Directive 2014/53/EU. The full text of the EU declaration of conformity is available at the following internet address: www.datalogic.com . |
| FR | Le soussigné, Datalogic S.r.l., déclare que l'équipement radioélectrique du type SKORPIO X3 est conforme à la directive 2014/53/UE. Le texte complet de la déclaration UE de conformité est disponible à l'adresse internet suivante: www.datalogic.com . |
| HR | Datalogic S.r.l. ovime izjavljuje da je radijska oprema tipa SKORPIO X3 u skladu s Direktivom 2014/53/EU. Cjeloviti tekst EU izjave o sukladnosti dostupan je na sljedećoj internetskoj adresi: www.datalogic.com . |
| IT | Il fabbricante, Datalogic S.r.l., dichiara che il tipo di apparecchiatura radio SKORPIO X3 è conforme alla direttiva 2014/53/UE. Il testo completo della dichiarazione di conformità UE è disponibile al seguente indirizzo Internet: www.datalogic.com . |
| LV | Ar šo Datalogic S.r.l. deklarē, ka radioiekārta SKORPIO X3 atbilst Direktīvai 2014/53/ES. Pilns ES atbilstības deklarācijas teksts ir pieejams šādā interneta vietnē: www.datalogic.com . |
| LT | Aš, Datalogic S.r.l., patvirtinu, kad radijo įrenginių tipas SKORPIO X3 atitinka Direktyvą 2014/53/ES. Visas ES atitikties deklaracijos tekstas prieinamas šiuo interneto adresu: www.datalogic.com . |
| HU | Datalogic S.r.l. igazolja, hogy a SKORPIO X3 típusú rádióberendezés megfelel a 2014/53/EU irányelvnek. Az EU-megfelelőségi nyilatkozat teljes szövege elérhető a következő internetes címen: www.datalogic.com . |
| MT | B'dan, Datalogic S.r.l. niddikjara li dan it-tip ta' tagħmir tar-radju SKORPIO X3 huwa konformi mad-Direttiva 2014/53/UE. It-test kollu tad-dikjarazzjoni ta' konformità tal-UE huwa disponibbli f'dan l-indirizz tal-Internet li ġej: www.datalogic.com . |
| PL | Datalogic S.r.l. niniejszym oświadcza, że typ urządzenia radiowego SKORPIO X3 jest zgodny z dyrektywą 2014/53/UE. Pełny tekst deklaracji zgodności UE jest dostępny pod następującym adresem internetowym: www.datalogic.com . |
| PT | O(a) abaixo assinado(a) Datalogic S.r.l. declara que o presente tipo de equipamento de rádio SKORPIO X3 está em conformidade com a Diretiva 2014/53/UE. O texto integral da declaração de conformidade está disponível no seguinte endereço de Internet: www.datalogic.com . |

| | |
|----|--|
| RO | Prin prezenta, Datalogic S.r.l. declară că tipul de echipamente radio SKORPIO X3 este în conformitate cu Directiva 2014/53/UE. Textul integral al declarației UE de conformitate este disponibil la următoarea adresă internet: www.datalogic.com . |
| SK | Datalogic S.r.l. týmto vyhlasuje, že rádiové zariadenie typu SKORPIO X3 je v súlade so smernicou 2014/53/EÚ. Úplné EÚ vyhlásenie o zhode je k dispozícii na tejto internetovej adrese: www.datalogic.com . |
| SL | Datalogic S.r.l. potrjuje, da je tip radijske opreme SKORPIO X3 skladen z Direktivo 2014/53/EU. Celotno besedilo izjave EU o skladnosti je na voljo na naslednjem spletnem naslovu: www.datalogic.com . |
| FI | Datalogic S.r.l. vakuuttaa, että radiolaitetyyppi SKORPIO X3 on direktiivin 2014/53/EU mukainen. EU-vaatimustenmukaisuusvakuutuksen täysimittainen teksti on saatavilla seuraavassa internetosoitteessa: www.datalogic.com . |
| SV | Härmed försäkrar Datalogic S.r.l. att denna typ av radioutrustning SKORPIO X3 överensstämmer med direktiv 2014/53/EU. Den fullständiga texten till EU-försäkran om överensstämmelse finns på följande webbadress: www.datalogic.com . |

Information for the User

ENGLISH

Contact the competent authority responsible for the management of radio frequency devices of your country to verify any possible restrictions or licenses required.

ITALIANO

Prendi contatto con l'autorità competente per la gestione degli apparati a radio frequenza del tuo paese, per verificare eventuali restrizioni o licenze.

FRANÇAIS

Contactez l'autorité compétente en la gestion des appareils à radio fréquence de votre pays pour vérifier d'éventuelles restrictions ou licences.

DEUTSCH

Wenden Sie sich an die für Radiofrequenzgeräte zuständige Behörde Ihres Landes, um zu prüfen ob es Einschränkungen gibt, oder eine Lizenz erforderlich ist.

ESPAÑOL

Contacta la autoridad competente para la gestión de los dispositivos de radio frecuencia de tu país, para verificar cualesquiera restricciones o licencias posibles requerida.

FREQUENCY RANGES

Bluetooth and Wi-Fi radio:

2400-2483.5 MHz eirp < 20 dBm,

Wi-Fi 5 GHz.

5150-5350 < eirp 20 dBm,

5470-5725 < eirp 20 dBm.

FCC COMPLIANCE

FCC Interference Statement

- This device complies with part 15 of the FCC Rules. Operation is subject to the following two conditions: (1) This device may not cause harmful interference, and (2) this device must accept any interference received, including interference that may cause undesired operation.
- This device has been tested and found to comply with the limits for a Class B digital device, pursuant to Part 15 of the FCC Rules. These limits are designed to provide reasonable protection against harmful interference in a residential installation. This equipment generates, uses and can radiated radio frequency energy and, if not installed and used in accordance with the instructions, may cause harmful interference to radio communi- cations. However, there is no guarantee that interference will not occur in a particular installation. If this equipment does cause harmful interference to radio or television reception, which can be determined by turning the equipment off and on, the user is encouraged to try to correct the interference by one or more of the following measures:
 - Reorient or relocate the receiving antenna.
 - Increase the separation between the equipment and receiver.
 - Connect the equipment into an outlet on a circuit different from that to which the receiver is connected.
 - Consult the dealer or an experienced radio/TV technician for help.Changes or modifications not expressly approved by the party responsible for compliance could void the user's authority to operate the equipment.
- The antenna(s) used for this transmitter must not be co-located or operating in conjunction with any other antenna or transmitter.
- This device is restricted to indoor use when operated in the 5.15 to 5.25 GHz frequency range.

IMPORTANT NOTE:**FCC Radiation Exposure Statement**

This model device meets the government's requirements for exposure to radio waves. This device is designed and manufactured not to exceed the emission limits for exposure to radio frequency (RF) energy set by the Federal Communications Commission of the U.S. Government.

The exposure standard for wireless devices employs a unit of measurement known as the Specific Absorption Rate, or SAR.

The SAR limit set by the FCC is 1.6W/kg. Tests for SAR are conducted using standard operating positions accepted by the FCC with the device transmitting at its highest certified power level in all tested frequency bands. Although the SAR is determined at the highest certified power level, the actual SAR level of the device while operating can be well below the maximum value. This is because the device is designed to operate at multiple power levels so as to use only the power required to reach the network. In general, the closer you are to a wireless base station antenna, the lower the power output.

While there may be differences between the SAR levels of various devices and at various positions, they all meet the government requirement.

The FCC has granted an Equipment Authorization for this model device with all reported SAR levels evaluated as in compliance with the FCC RF exposure guidelines. SAR information on this model device is on file with the FCC and can be found under the Display Grant section of <http://www.fcc.gov/oet/fccid> after searching on the below FCC ID:

U4GN030.

This device is compliant with SAR for general population /uncontrolled exposure limits in ANSI/IEEE C95.1-1999 and had been tested in accordance with the measurement methods and procedures specified in OET Bulletin 65 Supplement C. For body worn operation, this device has been tested and meets the FCC RF exposure guidelines for use with an accessory that contains no metal and the positions the handset a minimum of 1.5 cm from the body. Use of other enhancements may not ensure compliance with FCC RF exposure guidelines. If you do not use a body-worn accessory and are not holding the device at the ear, position the handset a minimum of 1.5 cm from your body when the device is switched on.

INDUSTRY CANADA COMPLIANCE

IC Statement:

This device complies with RSS-210 of the Industry Canada Rules.

Operation is subject to the following two conditions: (1) This device may not cause harmful interference, and (2) this device must accept any interference received, including interference that may cause undesired operation.

Ce dispositif est conforme à la norme CNR-210 d'Industrie Canada applicable aux appareils radio exempts de licence. Son fonctionnement est sujet aux deux conditions suivantes: (1) le dispositif ne doit pas produire de brouillage préjudiciable, et (2) ce dispositif doit accepter tout brouillage reçu, y compris un brouillage susceptible de provoquer un fonctionnement indésirable.

Caution:

(i) the device for operation in the band 5150-5250 MHz is only for indoor use to reduce the potential for harmful interference to co-channel mobile satellite systems;

(ii) the maximum antenna gain permitted for devices in the bands 5250-5350 MHz and 5470-5725 MHz shall comply with the e.i.r.p. limit; and.

(iii) the maximum antenna gain permitted for devices in the band 5725-5825 MHz shall comply with the e.i.r.p. limits specified for point-to-point and non point-to-point operation as appropriate.

(iv) Users should also be advised that high-power radars are allocated as primary users (i.e. priority users) of the bands 5250-5350 MHz and 5650-5850 MHz and that these radars could cause interference and/or damage to LE-LAN devices

Avertissement:

Le guide d'utilisation des dispositifs pour réseaux locaux doit inclure des instructions précises sur les restrictions susmentionnées, notamment :

(i) les dispositifs fonctionnant dans la bande 5 150-5 250 MHz sont réservés uniquement pour une utilisation à l'intérieur afin de réduire les risques de brouillage préjudiciable aux systèmes de satellites mobiles utilisant les mêmes canaux;

(ii) le gain maximal d'antenne permis pour les dispositifs utilisant les bandes 5 250-5 350 MHz et 5 470-5 725 MHz doit se conformer à la limite de p.i.r.e.;

(iii) le gain maximal d'antenne permis (pour les dispositifs utilisant la bande 5 725-5 825 MHz) doit se conformer à la limite de p.i.r.e. spécifiée pour l'exploitation point à point et non point à point, selon le cas.

(iv) De plus, les utilisateurs devraient aussi être avisés que les utilisateurs de radars de haute puissance sont désignés utilisateurs principaux (c.-à-d., qu'ils ont la priorité) pour les bandes 5 250-5 350 MHz et 5 650-5 850 MHz et que ces radars pourraient causer du brouillage et/ou des dommages aux dispositifs LAN-EL

IMPORTANT NOTE:**IC Radiation Exposure Statement:**

The product comply with the Canada portable RF exposure limit set forth for an uncontrolled environment and are safe for intended operation as described in this manual. The further RF exposure reduction can be achieved if the product can be kept as far as possible from the user body or set the device to lower output power if such function is available.

Déclaration d'exposition aux radiations:

Le produit est conforme aux limites d'exposition pour les appareils portables RF pour les Etats-Unis et le Canada établies pour un environnement non contrôlé.

Le produit est sûr pour un fonctionnement tel que décrit dans ce manuel. La réduction aux expositions RF peut être augmentée si l'appareil peut être conservé aussi loin que possible du corps de l'utilisateur ou que le dispositif est réglé sur la puissance de sortie la plus faible si une telle fonction est disponible.

SAR COMPLIANCE

This product has been tested and found to comply with the following standards:

- OET BULLETIN 65 SUPPLEMENT C: evaluating compliance with FCC guidelines for human exposure to radio frequency electromagnetic fields.
- EN 62311:2008: assessment of electronic and electrical equipment related to human exposure restrictions for electromagnetic fields (0 Hz – 300 GHz).
- EN 62479:2010: Assessment of the compliance of lower power electronic and electrical equipment with the basic restrictions related to human exposure to electromagnetic fields (10 MHz to 300 GHz).
- IC RSS 102 Issue 4: Radio Frequency (RF) Exposure Compliance of Radiocommunication Apparatus (All Frequency Bands).

SAR Information (for European Union)

Head: 0.117 W/kg@10g (CE); Body: 0.080 W/kg@10g (CE);

This device is restricted to indoor use only when operating in the 5150 to 5350 MHz frequency range.

FCC SAR values:

Head: 0.432 w/kg@1g

Body -Worn: 0.068W/kg@1g

Hand: 0.438 W/Kg@10g

Body-worn Operation

This device was tested for typical body-worn operations. A minimum separation distance must be maintained between the user's body and the handset, including the antenna:

0.5 cm to comply with the RF exposure requirements in Europe Third-party belt-clips, holsters and similar accessories used by this device should not contain any metallic components. Body-worn accessories that do not meet these requirements may not comply with RF exposure requirements and should be avoided.

WEEE COMPLIANCE



Informazione degli utenti ai sensi della Direttiva Europea 2002/96/EC

L'apparecchiatura che riporta il simbolo del bidone barrato deve essere smaltita, alla fine della sua vita utile, separatamente dai rifiuti urbani.

Smaltire l'apparecchiatura in conformità alla presente Direttiva consente di:

- evitare possibili conseguenze negative per l'ambiente e per la salute umana che potrebbero invece essere causati dall'errato smaltimento dello stesso;
- recuperare materiali di cui è composto al fine di ottenere un importante risparmio di energia e di risorse.

Per maggiori dettagli sulle modalità di smaltimento, contattare il Fornitore dal quale è stata acquistata l'apparecchiatura o consultare la sezione dedicata sul sito <http://www.datalogic.com>.

Information for the user in accordance with the European Commission Directive 2002/96/EC

At the end of its useful life, the product marked with the crossed out wheeled wastebin must be disposed of separately from urban waste.

Disposing of the product according to this Directive:

- avoids potentially negative consequences to the environment and human health which otherwise could be caused by incorrect disposal
- enables the recovery of materials to obtain a significant savings of energy and resources.

For more detailed information about disposal, contact the supplier that provided you with the product in question or consult the dedicated section at the website <http://www.datalogic.com>.

Information aux utilisateurs concernant la Directive Européenne 2002/96/EC

Au terme de sa vie utile, le produit qui porte le symbole d'un caisson à ordures barré ne doit pas être éliminé avec les déchets urbains.

Éliminer ce produit selon cette Directive permet de:

- éviter les retombées négatives pour l'environnement et la santé dérivant d'une élimination incorrecte
- récupérer les matériaux dans le but d'une économie importante en termes d'énergie et de ressources

Pour obtenir des informations complémentaires concernant l'élimination, veuillez contacter le fournisseur auprès duquel vous avez acheté le produit ou consulter la section consacrée au site Web <http://www.datalogic.com>.

Información para el usuario de acuerdo con la Directiva Europea 2002/96/CE

Al final de su vida útil, el producto marcado con un símbolo de contenedor de basura móvil tachado no debe eliminarse junto a los desechos urbanos.

Eliminar este producto de acuerdo con la Directiva permite de:

- evitar posibles consecuencias negativas para el medio ambiente y la salud derivadas de una eliminación inadecuada
- recuperar los materiales obteniendo así un ahorro importante de energía y recursos

Para obtener una información más detallada sobre la eliminación, por favor, póngase en contacto con el proveedor donde lo compró o consultar la sección dedicada en el Web site <http://www.datalogic.com>.

Benutzerinformation bezüglich Richtlinie 2002/96/EC der europäischen Kommission

Am Ende des Gerätelebenszyklus darf das Produkt nicht über den städtischen Hausmüll entsorgt werden. Eine entsprechende Mülltrennung ist erforderlich.

Beseitigung des Produkts entsprechend der Richtlinie:

- verhindert negative Auswirkungen für die Umwelt und die Gesundheit der Menschen
- ermöglicht die Wiederverwendung der Materialien und spart somit Energie und Ressourcen

Weitere Informationen zu dieser Richtlinie erhalten sie von ihrem Lieferanten über den sie das Produkt erworben haben, oder besuchen sie unsere Homepage unter <http://www.datalogic.com>.

GLOSSARY

Access Point

A device that provides transparent access between Ethernet wired networks and IEEE 802.11 interoperable radio-equipped mobile units. Hand-held mobile computers, PDAs or other devices equipped with radio cards, communicate with wired networks using Access Points (AP). The mobile unit (mobile computer) may roam among the APs in the same subnet while maintaining a continuous, seamless connection to the wired network.

Applet

Diminutive form of app (application), it refers to simple, single-function programs that often ship with a larger product. Programs such as Windows' Calculator, File Manager, Control Panel and Notepad are examples of applets.

Bar Code

A pattern of variable-width bars and spaces which represents numeric or alphanumeric data in binary form. The general format of a barcode symbol consists of a leading margin, start character, data or message character, check character (if any), stop character, and trailing margin. Within this framework, each recognizable symbology uses its own unique format.

Baud Rate

A measure for data transmission speed.

Bit

Binary digit. One bit is the basic unit of binary information. Generally, eight consecutive bits compose one byte of data. The pattern of 0 and 1 values within the byte determines its meaning.

Bluetooth®

A standard radio technology using a proprietary protocol. The onboard Bluetooth® module in the device is compatible with the 2.1 protocol with Enhanced Data Rate (EDR).

Byte

On an addressable boundary, eight adjacent binary digits (0 and 1) combined in a pattern to represent a specific character or numeric value. Bits are numbered from the right, 0 through 7, with bit 0 the low-order bit. One byte in memory can be used to store one ASCII character.

Decode

To recognize a bar code symbology (e.g., Codabar, Code 128, Code 3 of 9, UPC/EAN, etc.) and convert the content of the bar code scanned from a visual pattern into electronic data.

Depth of Field (DOF)

The portion of a scene that appears acceptably sharp in the image. Although a lens can precisely focus at only one distance, the decrease in sharpness is gradual on each side of the focused distance, so that within the DOF, the unsharpness is imperceptible under normal viewing conditions.

EEPROM

Electrically Erasable Programmable Read-Only memory. An on-board non-volatile memory chip.

Ethernet

The standard local area network (LAN) access method. A reference to "LAN," "LAN connection" or "network card" automatically implies Ethernet. Defined by the IEEE as the 802.3 standard, Ethernet is used to connect computers in a company or home network as well as to connect a single computer to a cable modem or DSL modem for Internet access.

Firmware

Firmware is a software program or set of instructions programmed on a hardware device. It provides the necessary instructions for how the device communicates with the other computer hardware. Firmware is typically stored in the flash ROM of a hardware device. While ROM is "read-only memory," flash ROM can be erased and rewritten because it is actually a type of flash memory.

Flash Disk

Non-volatile memory for storing application and configuration files.

Host

A computer that serves other mobile computers in a network, providing services such as network control, database access, special programs, supervisory programs, or programming languages.

IEEE 802.11

A set of standards carrying out wireless local area network (WLAN) computer communication in the 2.4, 3.6 and 5 GHz frequency bands. They are created and maintained by the IEEE LAN/MAN Standards Committee.

Light Emitting Diode (LED)

A low power electronic light source commonly used as an indicator light. It uses less power than an incandescent light bulb but more than a Liquid Crystal Display (LCD).

Liquid Crystal Display (LCD)

A display that uses liquid crystal sealed between two glass plates. The crystals are excited by precise electrical charges, causing them to reflect light outside according to their bias. They use little electricity and react relatively quickly. They require external light to reflect their information to the user.

Null modem cable

RS-232 serial cable where the transmit and receive lines are crosslinked. In some cables there are also handshake lines crosslinked. In many situations a straight through serial cable is used, together with a null modem adapter. The adapter contains the necessary crosslinks between the signals.

One shot key

Pressing a one shot key activates the state. The state remains active until any other key is pressed. If you hold down a one shot state key and you press another key the state will remain active until you release the one-shot key.

Pairing

A Bluetooth® pairing occurs when two Bluetooth® devices agree to communicate with each other and establish a connection.

Piconet

A piconet is a Bluetooth® PAN that links up to eight devices. Each piconet is controlled by one master device, and up to seven slave devices at any one time. Any device may be a member of more than one piconet, changing its membership as a user moves from one area to another.

RAM

Random Access Memory. Data in RAM can be accessed in random order, and quickly written and read.

RF

Radio Frequency.

RTC

Real Time Clock.

TDMA

Time division multiple access (TDMA) is digital transmission technology that allows a number of users to access a single radio-frequency (RF) channel without interference by allocating unique time slots to each user within each channel. The TDMA digital transmission scheme multiplexes three signals over a single channel. The current TDMA standard for cellular divides a single channel into six time slots, with each signal using two slots, providing a 3 to 1 gain in capacity over advanced mobile-phone service (AMPS). Each caller is assigned a specific time slot for transmission.

Toggle key

Pressing a toggle key activates the state. The state remains active until the toggle key is pressed again.

USB

Universal Serial Bus. Type of serial bus that allows peripheral devices (disks, modems, printers, digitizers, data gloves, etc.) to be easily connected to a computer. A "plug-and-play" interface, it allows a device to be added without an adapter card and without rebooting the computer (the latter is known as hot-plugging). The USB standard, developed by several major computer and telecommunications companies, supports data-transfer speeds up to 12 megabits per second, multiple data streams, and up to 127 peripherals.

WLAN

A Wireless Local Area Network links devices via a wireless distribution method (typically spread-spectrum or OFDM radio), and usually provides a connection through an access point to the wider internet. This gives users the mobility to move around within a local coverage area and still be connected to the network.

WPAN

A Wireless Personal Area Network is a personal area network - a network for interconnecting devices centered around an individual person's workspace - in which the connections are wireless. Typically, a wireless personal area network uses some technology that permits communication within about 10 meters - in other words, a very short range.

INDEX

A

Accessories; 9
Audio Settings; 67
Available Models; 3

B

Backup Directory File Management;
80
Batteries and Maintenance; 10
Bluetooth® Manager Device Setup;
71

C

Canadian Statement; 126
Charging the Batteries; 10
Cleaning the mobile computer; 16
Connecting to other Computers; 69
Connection Cables; 25
RS232 Direct Connection; 25
Connections; 17
Connection to USB peripherals; 19
RS232 Connection; 21
USB Connection; 17
WLAN Connection; 22
WPAN Connections; 24
Control Panel; 44

D

Data Capture; 31
Imager Data Capture; 33
Laser Data Capture; 32
Linear Imager Data Capture; 35
Data Capture Configuration; 45
Datalogic Configuration Utility; 84
Datalogic Desktop Utility; 85
Datalogic Firmware Utility; 81
Description of the Keyboards; 37
DL Buttons; 49

F

FCC Compliance; 131
Files Admin; 56
FTP Server Setup; 79

G

General View; vii
Glossary; 137

I

Industry Canada Compliance; 133

L

Laser Safety; 120
LED Class; 126
LED Status; 42

M

Marking and European Economic
Area (EEA); 127
Memor Description; 1
MicroSD Card Insertion; 5

P

Package Contents; 4
Power Supply; 119

R

Reading Diagrams; 112
References; vi
Registry; 55
Replacing the Batteries; 12
Resetting the Memor X3; 40

S

Safe Setup; 56
Safety Regulations; 119

SAR Compliance; 134
Save Session; 56
Startup; 28
Status Indicators; 42
Stylus Calibration; 64
Support Through the Website; vi

T

Taskbar; 43
Technical Data; 107
Technical Features; 107
Test Codes; 115

U

Using the Stylus; 30

W

WEEE Compliance; 135
Windows Mobile® Device Center; 69
Wireless and Radio Frequencies
Warnings; 26
Wireless Communications; 59



www.datalogic.com

©2013-2018 Datalogic S.p.A. and/or its affiliates ■ All rights reserved. ■
Datalogic and the Datalogic logo are registered trademarks of
Datalogic S.p.A. in many countries, including the U.S.A. and the E.U.

Datalogic S.r.l.

Via S. Vitalino, 13
40012 Calderara di Reno
Bologna - Italy
Telephone: (+39) 051-3147011
Fax: (+39) 051-3147205



822001591 (Rev. A) January 2018