

Touchmonitor User Guide

1938L 19" LCD Open-Frame Touchmonitor



Our commitment. Your advantage.

User Guide

19" LCD OPEN-FRAME TOUCHMONITOR

1938L Family 3000 Series

Revision B

P/N E481511

Copyright © 2008 Tyco Electronics. All Rights Reserved.

No part of this publication may be reproduced, transmitted, transcribed, stored in a retrieval system, or translated into any language or computer language, in any form or by any means, including, but not limited to, electronic, magnetic, optical, chemical, manual, or otherwise without prior written permission of Elo TouchSystems.

Disclaimer

The information in this document is subject to change without notice. Elo TouchSystems makes no representations or warranties with respect to the contents hereof, and specifically disclaims any implied warranties of merchantability or fitness for a particular purpose. Elo TouchSystems reserves the right to revise this publication and to make changes from time to time in the content hereof without obligation of Elo TouchSystems to notify any person of such revisions or changes.

Trademark Acknowledgments

IntelliTouch, SecureTouch, TE logo and Tyco Electronics are trademarks. Other product names mentioned herein may be trademarks or registered trademarks of their respective companies. Tyco Electronics claims no interest in trademarks other than its own.

Table of Contents

Chapter 1	
Introduction	7
Product Description	7
Precautions	7
About the Product	8
Chapter 2	
Installation and Setup	9
Unpacking Your Touchmonitor	9
Touch Interface Connection	10
Monitor Mounting	11
VESA Mounting	11
Attaching the L-Bracket	14
Product Overview	15
Front View	15
Rear View	15
Installing the Driver Software	16
Installing the Serial Touch Driver	17
Installing the Serial Touch Driver for Windows XP, Windows 2000, Me, 95/98 and NT 4.0	17
Installing the Serial Touch Driver for MS-DOS and Windows 3.1	18
Installing the USB Touch Driver	19
Installing the USB Touch Driver for Windows XP, Windows 2000, Me, 95/98 and NT 4.0	19
Installing APR USB Touch Driver for Windows XP	20
Chapter 3	
Operation	21
About Touchmonitor Adjustments	21
Rear Panel Controls	22
Remote OSD Buttons (option)	22
Controls and Adjustment	23
On Screen Display (OSD) Menu Functions	23
On Screen Display (OSD) Control Options	24
Preset Modes	25
Power Management System	25
Chapter 4	
Troubleshooting	27
Solutions to Common Problems	27
Appendix A	
Native Resolution	28
Appendix B	
Touchmonitor Safety	30
Care and Handling of Your Touchmonitor	31
Appendix C	
Touchmonitor Specifications	33
IntelliTouch Touchscreen Specifications	34
Surface Capacitive Touchscreen Specifications	35
SecureTouch Touchscreen Specifications	36
Acoustic Pulse Recognition Specifications	37
19" LCD Touchmonitor (ET1938L-XXXA-X-G) Dimensions	38
Regulatory Information	39
Warranty	42
Index	43

1

INTRODUCTION

Product Description

Your new touchmonitor combines the reliable performance of touch technology with the latest advances in (LCD) display design. This combination of features creates a natural flow of information between a user and your touchmonitor.

This LCD monitor incorporates a 19" color active matrix thin-film-transistor (TFT) to provide superior display performance. A maximum resolution of WXGA 1440 x 900 is ideal for displaying graphics and images. Other outstanding features that enhance this LCD monitor's performance are Plug & Play compatibility, and On-Screen Display (OSD) controls.

Precautions

Follow all warnings, precautions and maintenance as recommended in this user's manual to maximize the life of your unit. See Appendix B, page B-31, for more information on touchmonitor safety.

About the Product

Your LCD open-frame touchmonitor is a 19" WXGA TFT color display with the following features:

- The internal microprocessor digitally controls auto-scanning for horizontal scan frequencies between 31.5 KHz and 80 KHz, and vertical scan frequencies between 56.3 Hz and 75.0 Hz. In each frequency mode, the microprocessor-based circuitry allows the monitor to function at the precision of a fixed frequency.
- High contrast color TFT LCD display supports resolutions up to WXGA 1440 x 900.
- Compatible with VGA, SVGA, XGA, SXGA (non-interlaced) and most Macintosh compatible color video cards.
- Power management system conforms to VESA DPMS standard.
- Supports DDC 2B for Plug & Play compatibility.
- Advanced On Screen Display (OSD) control for picture quality adjustment.

For full Product Specifications refer to Appendix C, page C-33.

INSTALLATION AND SETUP

This chapter discusses how to install your LCD touchmonitor and the driver software.

Unpacking Your Touchmonitor

Check that the following 9 items are present and in good condition:



LCD touchmonitor

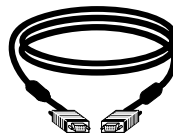

Video cable

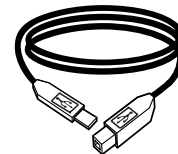

USB cable

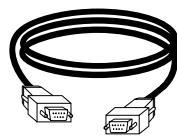

Serial cable

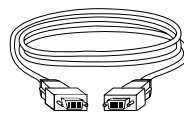

DVI-D Cable

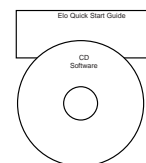

Touch Tools CD + Quick Install Guide

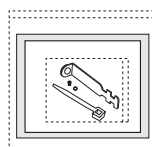

Strain Relief kit

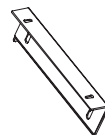

Mounting Brackets

- Note:
1. DVI cable is only included on DVI models
 2. Please visit the 1938L product page located at www.elotouch.com for full listing of optional power brick/cable sets.

Touch Interface Connection

Note: Before connecting the cables to your touchmonitor and PC, be sure that the computer and touchmonitor are turned off.

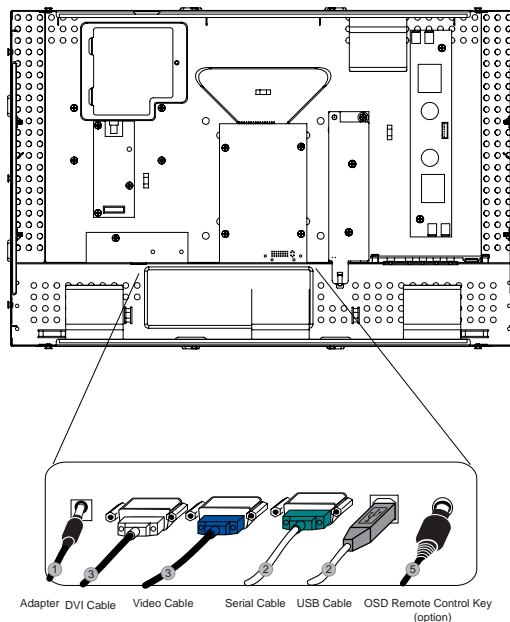

1. Connect one end of the **power adapter** to the monitor and the other end to the connector of the power cord.
2. Connect one end of either the **touchscreen serial (RS232) cable** or the touchscreen USB cable (but not both) to the rear side of the computer and the other end to the LCD touchmonitor. Tighten by turning the two thumb screws clockwise to ensure proper grounding (USB cable does not have thumb screws).
3. Connect one end of the **video/DVI cable** to the rear side of computer and the other to the LCD touchmonitor. Tighten by turning the two thumb screws clockwise to ensure proper grounding.
4. Press the **power button** on the rear panel to turn the monitor power on.
5. Connect **OSD remote control key** (optional) to the monitor.

Product Overview

Front View

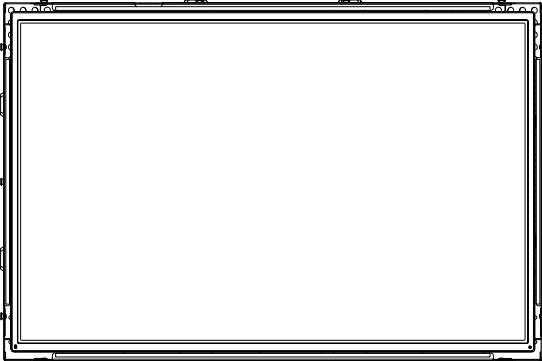

Rear View

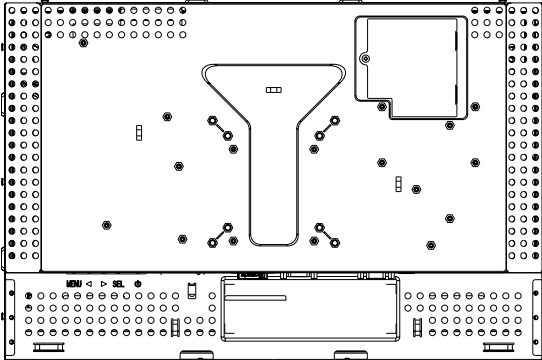

Monitor Mounting

VESA Mounting

Your touchscreen display conforms to the VESA Flat Panel Monitor Physical Mounting Interface (FPMPMI) standard. The FPMPMI standard defines a physical mounting interface for flat panel displays. Your display conforms to the corresponding standards for flat panel display mounting devices, such as for table arms. The VESA mounting interface is located on the back of your touch screen display.

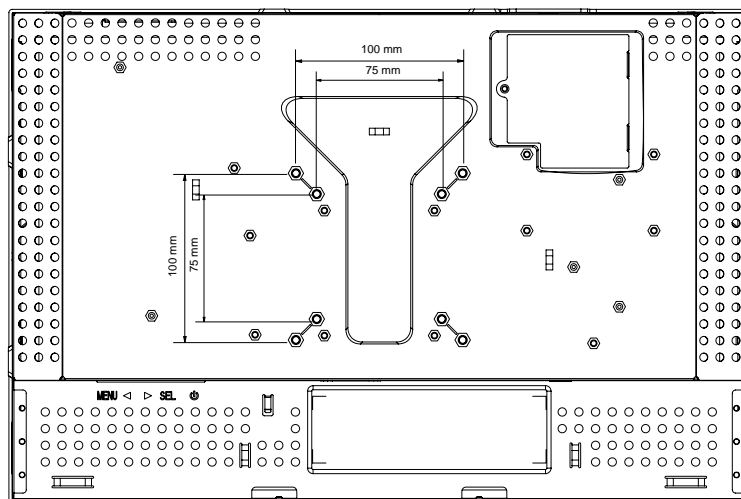

Rear View of monitor

Note:

Screw, M4 Phillips, X4

You will need a Phillips screwdriver to mount the display.

The mounting stand shall be able sustain at least 5Kg and UL Listed.

The mount allows the monitor to be tilted downwards up to a 90° for an improved viewing angle from vertical, as shown in the illustrations below.

Landscape orientation

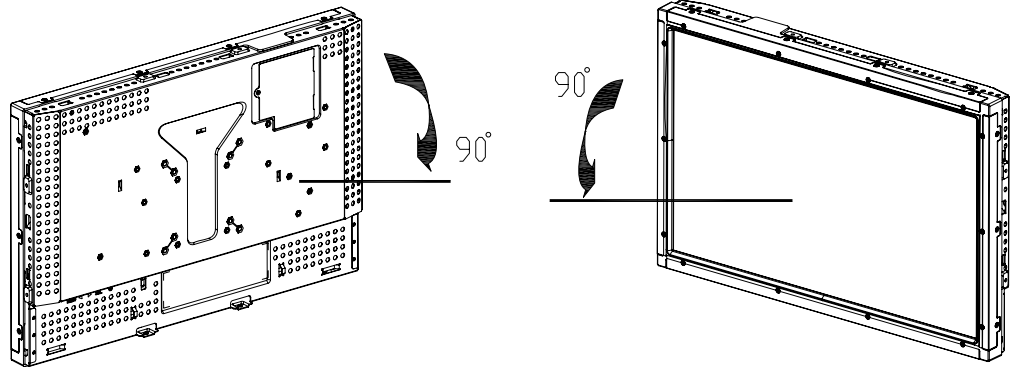

Portrait orientation

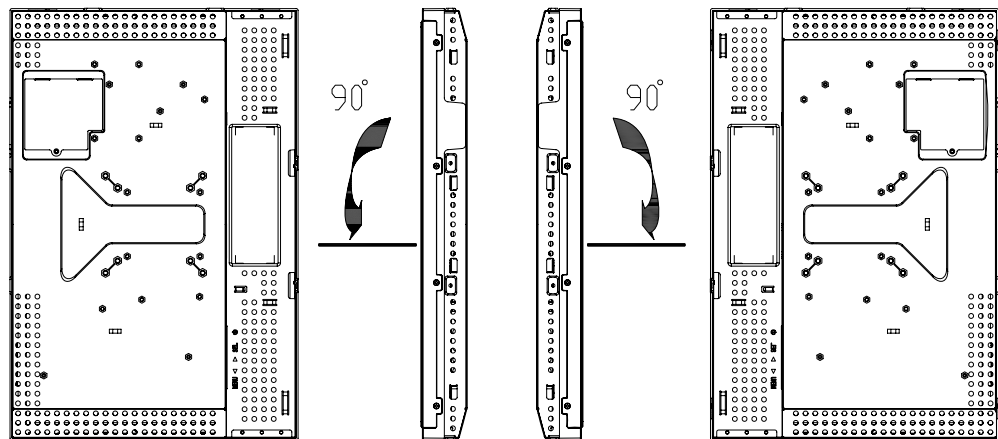

Attaching the L-Brackets

Depending on your mounting scheme, alternately, you may use two L-brackets to mount your displays onto your device.

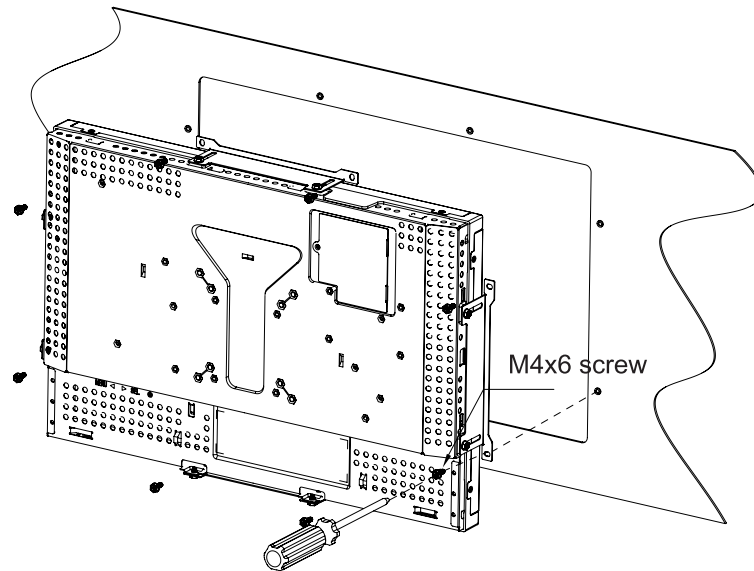

Find a suitable location for attaching L-brackets.

- A. The left and right sides or
- B. The Top and bottom sides

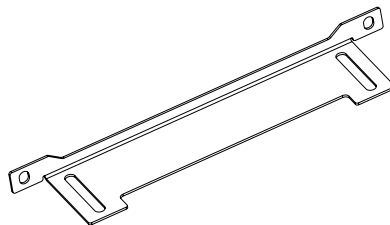
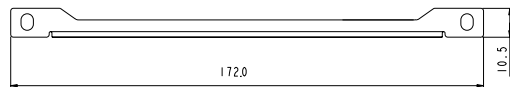
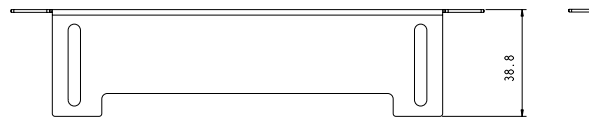

Customer panel material:

1. Wood: 24.5mm holes thru for M4 screws w/nuts, or no thru holes, screws for wood 4mm.
2. Sheet metal: concealed head threaded studs M4 w/nuts.

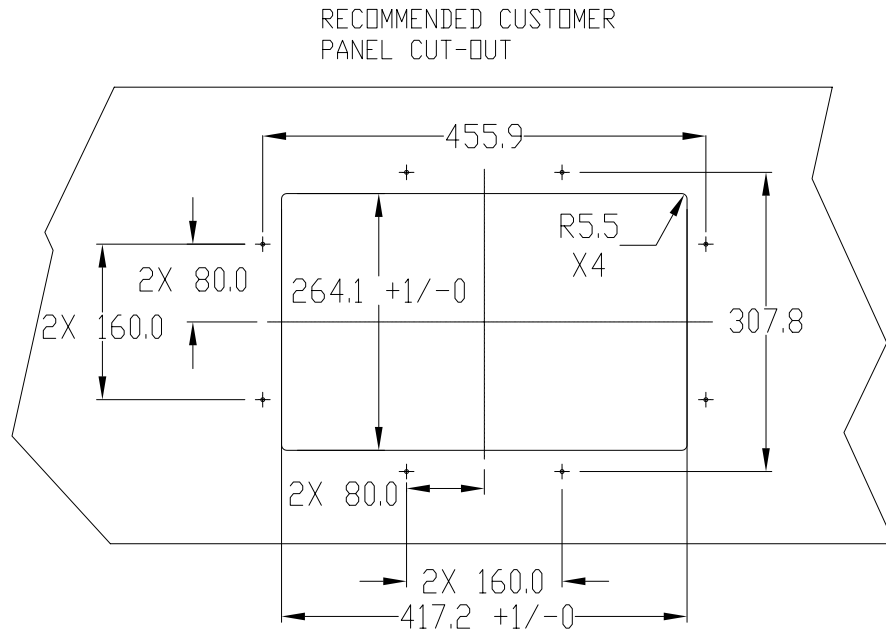

IMPORTANT!

The wall mounting instructions are for us by the qualified wall mounting person only!

Note

You will need a screwdriver to attach the L-brackets.

Your kiosk touchmonitor included two L-brackets (and four screws, M4x6).

This equipment is intended to be mounted in accordance with the proper hardware and the installation instructions supplied with the product. Use of mounting brackets or screws other than those specified in the installation instructions may introduce a hazard.

Monitor Mounting

Installing the Driver Software

Elo TouchSystems provides driver software that allows your touchmonitor to work with your computer. Drivers are located on the enclosed CD-ROM for the following operating systems:

- Windows XP
- Windows 2000
- Windows Me
- Windows 98
- Windows 95
- Windows NT 4.0

The latest versions of drivers and driver information for other operating systems are available on the Elo TouchSystems web site at <http://elotouch.com/Support/Downloads/dnld.asp>

Your Elo touchmonitor is Plug-and-Play compliant. Information on the video capabilities of your touchmonitor is sent to your video display adapter when Windows starts. If Windows detects your touchmonitor, follow the instructions on the screen to install a generic Plug-and-Play monitor.

Refer to the appropriate section for driver installation instructions.

Depending upon whether you connected the serial communication cable or the USB communication cable, you should install only the serial driver or the USB driver.

Installing the Serial Touch Driver

Installing the Serial Touch Driver for Windows XP, Windows 2000, Me, 95/98 and NT 4.0

NOTE: For Windows 2000 and NT 4.0 you must have administrator access rights to install the driver.

To install Windows 2000 and Windows XP, you must use the "update driver" method; you will not find a setup.exe file within the download.

1. Insert the Elo CD-ROM in your computer's CD-ROM drive.
2. If the AutoStart feature for your CD-ROM drive is active, the system automatically detects the CD and starts the setup program.
3. Follow the directions on the screen to complete the driver setup for your version of Windows.
4. If the AutoStart feature is not active:
 - a. Click **Start > Run**.
 - b. Click the **Browse** button to locate the EloCd.exe program on the CD-ROM.
 - c. Click **Open**, then **OK** to run EloCd.exe.
5. Follow the directions on the screen to complete the driver setup for your version of Windows.

Installing the Serial Touch Driver for MS-DOS and Windows 3.1

You must have a DOS mouse driver (MOUSE.COM) installed for your mouse if you wish to continue using your mouse along with your touchmonitor in DOS.

To install Windows 3.x and MS-DOS from Windows 95/98, follow the directions below:

1. Insert the CD-ROM in your computer's CD-ROM drive.
2. From DOS, type `d:\EloDos_W31` to change to the correct directory on the CD-ROM (your CD-ROM drive may be mapped to a different drive letter).
3. Type **INSTALL** and press **Enter** to start the installation.
4. Align the touchscreen.

You must have already completed Steps 1 and 2 before proceeding.

To run the **INSTALL** program:

1. Type **INSTALL** at the DOS prompt in the directory containing the driver install files.
2. **INSTALL** asks you to select the software to install. Then choose `d:\EloDos_W31` from the displayed list.
3. **INSTALL** also asks you for the paths to use during installation, or you may use its defaults. **INSTALL** creates directories as necessary, and warns you if they exist.

If you are updating your software, you may wish to specify the paths containing the earlier versions, and overwrite the obsolete files. All executable programs are upward compatible. For a list of differences from each previous version of the drivers, be sure to select "Differences from Previous Versions" during the installation process.

INSTALL updates your **AUTOEXEC.BAT** file with the drivers you select. **INSTALL** makes a copy of your original **AUTOEXEC.BAT** file, called **AUTOEXEC.OLD**. If you already have Elo driver commands in your **AUTOEXEC.BAT** file, they will be commented out.

When **INSTALL** is finished, it leaves a file called **GO.BAT** in the subdirectory you specified. **GO** loads the touchscreen driver, runs the calibration program **ELOCALIB**, and gives you some final instructions.

If you are using Windows 3.1, you will also calibrate the touchscreen within Windows 3.1 with the Touchscreen Control Panel.

Installing the USB Touch Driver

Installing the USB Touch Driver for Windows XP, Windows 2000, Me, 95/98 and NT 4.0

To install Windows 2000 and Windows XP, you must use the "update driver" method; you will not find a setup.exe file within the download.

NOTE: For Windows 2000 you must have administrator access rights to install the driver.

1. Insert the Elo CD-ROM in your computer's CD-ROM drive.
If running Windows 98, Windows ME or Windows 2000, the Add New Hardware Wizard starts.
2. Choose **Next**. Select "Search for the best driver for your device (Recommended)" and choose **Next**.
3. When a list of search locations is displayed, place a checkmark on "Specify a location" and use **Browse** to select the \EloUSB directory on the Elo CD-ROM.
4. Choose **Next**. Once the Elo USB touchscreen driver has been detected, choose **Next** again.
5. You will see several files being copied. Insert your Windows 98 CD if prompted. Choose **Finish**.

If Windows 98, Windows Me or Windows 2000 does not start the Add New Hardware Wizard.

1. Insert the Elo CD-ROM in your computer's CD-ROM drive. If the AutoStart feature for your CD-ROM drive is active, the system automatically detects the CD and starts the setup program.
2. Follow the directions on the screen to complete the driver setup for your version of Windows.

If the AutoStart feature is not active:

1. Click **Start > Run**.
2. Click the **Browse** button to locate the EloCd.exe program on the CD-ROM.
3. Click **Open**, then **OK** to run EloCd.exe.
4. Follow the directions on the screen to complete the driver setup for your version of Windows.

Installing APR USB Touch Driver for Windows XP

Insert the Elo APR CD-ROM in your computer's CD-ROM driver.

Follow the directions on the screen to complete the APR 2.0 driver setup for your version of Windows.

1. Click **Start > Run**.

2. Click the **Browse** button to locate the SW600117.exe program on the CD-ROM.

3. Click **Open**, then **OK** to run SW600117.exe.

4. Follow the directions on the screen to complete the driver setup for your version of Windows.

3

OPERATION

About Touchmonitor Adjustments

Your touchmonitor will not likely require adjustment. However, variations in video output and application may require adjustments to your touchmonitor to optimize the quality of the display.

For best performance, your touchmonitor should be operating in native resolution, 1440 x 900 at 60 Hz. Use the Display control panel in Windows to choose 1440 x 900 resolution.

Operating in other resolutions will degrade video performance. For further information, please refer to Appendix A, page A-25.

All control adjustments are automatically memorized. This feature saves you from having to reset your choices every time you unplug or power your touchmonitor off and on. If there is a power failure, your touchmonitor settings will not default to the factory specifications.

Rear Panel Controls

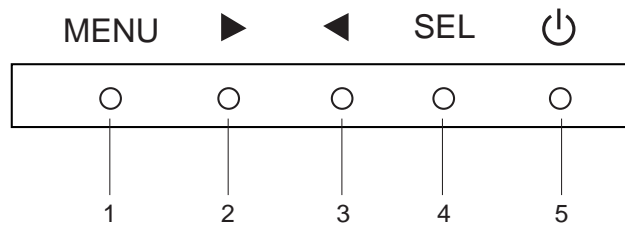

Control	Function
1. Menu/Exit	Display/exits the On Screen Display (OSD) menus.
2. ▶	1. Enter contrast of the OSD. 2. Increase value of the adjustment item.
3. ◀	3. Select item counter-clockwise. 1. Enter brightness adjustment. 2. Decrease value of the adjustment item.
4. Select	3. Select item clockwise. Selects the adjustment items from the OSD menus.
5. Power Switch	Switches the power of the monitor.

Remote OSD Buttons (option)

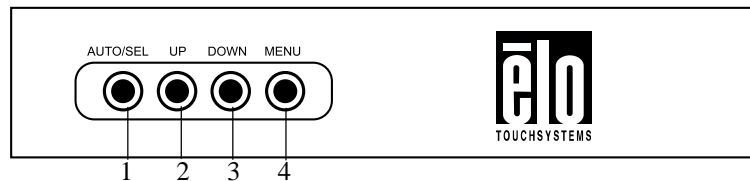

Control	Function
1. Menu/Exit	Display/exits the On Screen Display (OSD) menus.
2. ▶	1. Enter contrast of the OSD. 2. Increase value of the adjustment item.
3. ◀	3. Select item counter-clockwise. 1. Enter brightness adjustment. 2. Decrease value of the adjustment item.
4. Select	3. Select item clockwise. Selects the adjustment items from the OSD menus.

Controls and Adjustment

On Screen Display (OSD) Menu Functions

To Display and Select the OSD Functions:

1. Press the Menu key to activate the OSD menu.
2. Use ◀ or ▶ to move through the menu. Press the Select key, the parameter will be highlighted when selected.
3. To quit the OSD screen at any time during the operation, press the Menu key. If no keys are pressed for a short time period, the OSD automatically disappears.

NOTE: The OSD screen will disappear if no input activities are detected for 45 seconds.

On Screen Display (OSD) Control Options

Control	Description
Contrast	Increases or decreases contrast.
Brightness	Increases or decreases brightness.
V-Position	Moves the screen up or down.
H-Position	Moves the screen left or right.
Recall Defaults	Returns the monitor to its default settings.
RGB	Press ◀ or ▶ to select 9300, 6500, 5500, 7500 and USER. Only when selecting USER can you make adjustments to the R/G/B content. Press Enter to restore to factory default setting.
Resolution	Choose from preset options.
Sharpness	Adjusts the sharpness.
Phase	Increases or decreases the snow noise of the image after auto adjustment is made.
Clock	The dot clock is fine-adjusted after auto adjust.
OSD H-Position	Moves the OSD position horizontally on the screen. When the ▶ button is pressed, the OSD control menu will move to the right side of the screen. Likewise, when the ◀ button is pressed, the OSD control menu will move to the left side.
OSD V-Position	Moves the OSD position vertically on the screen. When the ▶ button is pressed, the OSD control menu will move to the top side of the screen. Likewise, when the ◀ button is pressed, the OSD control menu will move to the lower side.
OSD Time	Determines how long (in seconds) the OSD menu waits before closing automatically after no action has been performed.
Auto-Adjust	Press Auto to enable this function. The Auto-Adjust will automatically adjust V-Position, H-Position, Clock and Clock-Phase.
OSD Language	Select from English, French, German, Spanish, Japanese, Korean, Italian, Traditional Chinese, Simplified Chinese.
Information Description	Indicates the current resolution, H-Frequency and V-Frequency.

Preset Modes

To reduce the need for adjustment for different modes, the monitor has default setting modes that are most commonly used as given in the table below. If any of these display modes are detected, the monitor automatically adjusts the picture size and centering. When no mode is matched, the user can store their preferred modes in the user modes. The monitor is capable of storing up to 7 user modes. The only condition to store as a user mode is the new display information must have 1 KHz difference for horizontal frequency or 1 Hz for vertical frequency or the sync signal polarities are different from the default modes.

Mode	Resolution	H. Freq. (KHz)	Band Width (MHz)	H	V
1	VGA 640 x 350@70Hz	31.4	70	-	-
2	VGA 720 x 400@70Hz	31.4	70	-	+
3	VGA 640 x 480@60Hz	31.4	59.9	-	-
4	VGA 640 x 480@66Hz	35.0	66.6	+	+
5	VGA 640 x 480@72Hz	37.8	72.8	-	-
6	SGA 800 x 600@56Hz	35.1	56.2	+	+
7	SGA 800 x 600@60Hz	37.8	60.3	+	+
8	SGA 800 x 600@72Hz	48.0	72.1	+	+
9	XGA 1024 x 768@60Hz	48.3	60.0	-	-
10	XGA 1024 x 768@65Hz	53.9	66.1	-	+
11	XGA 1024 x 768@72Hz	57.6	72.0	-	-
12	XGA 1024 x 768@75Hz	60.0	75.0	+	+
13	SXGA 1280 x 1024@60Hz	63.9	60.0	+	+
14	SXGA 1280 x 1024@75Hz	79.9	75.0	+	+
15	1440 x 900@60Hz	67.5	75.0	-	+
16	1152 x 864@75Hz	56.48	75.0	+	+
17	1280 x 768@65Hz	51.8	65.0	+	+
18	1680 x 1050@60Hz	65.3	59.9	-	+
19	1366 x 768@60Hz	47.7	60.0	-	-
20	1280 x 960@60Hz	60.0	60.0	+	+
21	832 x 624@75Hz	60.0	108	+	+
22	1280 x 768@60Hz	47.7	79.5	-	+
23	1280 x 768@75Hz	60.3	102.3	-	+
24	1360 x 768@60Hz	47.7	60.0	+	+

Power Management System

The monitor is equipped with the power management function which automatically reduces the power consumption when not in use.

Mode	Power Consumption
On	<45W
Sleep	<4W
Off	<2W

We recommend utilizing a screensaver when the touchmonitor is not in use.

NOTE: The monitor automatically goes through the Power Management System (PMS) steps when it is idle. To activate the monitor, press any key on the keyboard or move the mouse.

4

TROUBLESHOOTING

If you are experiencing trouble with your touchmonitor, refer to the following table. If the problem persists, please contact your local dealer or our service center.

Solutions to Common Problems

Problem	Suggestion(s)
The monitor does not respond after you turn on the system	<ul style="list-style-type: none"> • Check that the monitor's Power Switch is on. • Turn off the power and check the monitor's power cord and signal cable for proper connection.
Characters on the screen are dim	<ul style="list-style-type: none"> • Refer to the About Touchmonitor Adjustments section to adjust the brightness.
The screen is blank	<ul style="list-style-type: none"> • During operation, the monitor screen may automatically turn off as a result of the Power Saving feature. Press any key to see if the screen reappears. • Refer to the About Touchmonitor Adjustments section, page 3-17, to adjust the brightness.
Screen flashes when initialized "Out of Range" display	<ul style="list-style-type: none"> • Turn the monitor off then turn it on again. • Check to see if the resolution of your computer is higher than that of the LCD display. • Reconfigure the resolution of your computer to make it less than or equal to 1440 x 900. See preset modes or Appendix A (page A-25) for more information on resolution.
Touch doesn't work	<ul style="list-style-type: none"> • Make sure the touch cable is securely attached at both ends.



NATIVE RESOLUTION

The native resolution of a monitor is the resolution level at which the LCD panel is designed to perform best. For the 1938L LCD touchmonitor, the native resolution is 1440 x 900. In almost all cases, screen images look best when viewed at their native resolution.

Input Video	19" LCD
640 x 480 (VGA)	Transforms input format to 1440 x 900
800 x 600 (SVGA)	Transforms input format to 1440 x 900
1024 x 768 (XGA)	Transforms input format to 1440 x 900
1280 x 1024 (SXGA)	Transforms input format to 1440 x 900
1440 x 900 (WXGA)	Displays in Native Resolution

The native resolution of an LCD is the actual number of pixels horizontally in the LCD by the number of pixels vertically in the LCD. LCD resolution is usually represented by the following symbols:

VGA	640 x 480
SVGA	800 x 600
XGA	1024 x 768
SXGA	1280 x 1024
WXGA+	1440 x 900
WSXGA+	1680 x 1050

As an example, a WXGA+ resolution LCD panel has 1440 pixels horizontally by 900 pixels vertically. Input video is also represented by the same terms. WXGA input video has a format of 1440 pixels horizontally by 900 pixels vertically. When the input pixels contained in the video input format match the native resolution of the panel, there is a one to one correspondence of mapping of input video pixels to LCD pixels. As an example, the pixel in column 45 and row 26 of the input video is in column 45 and row 26 of the LCD. For the case when the input video is at a lower resolution than the native resolution of the LCD, the direct correspondence between the video pixels and the LCD pixels is lost. The LCD controller can compute the correspondence between video pixels and LCD pixels using algorithms contained on its controller. The accuracy of the algorithms determines the fidelity of conversion of video pixels to LCD pixels. Poor fidelity conversion can result in artifacts in the LCD displayed image such as varying width characters.

B

TOUCHMONITOR SAFETY

This manual contains information that is important for the proper setup and maintenance of your touchmonitor. Before setting up and powering on your new touchmonitor, read through this manual, especially Chapter 2 (Installation), and Chapter 3 (Operation).

- 1 To reduce the risk of electric shock, follow all safety notices and never open the touchmonitor case.
- 2 Turn off the product before cleaning.
- 3 Your new touchmonitor is equipped with a 3-wire, grounding power cord. The power cord plug will only fit into a grounded outlet. Do not attempt to fit the plug into an outlet that has not been configured for this purpose. Do not use a damaged power cord. Use only the power cord that comes with your touchmonitor. Use of an unauthorized power cord may invalidate your warranty.
- 4 The slots located on the sides and top of the touchmonitor case are for ventilation. Do not block or insert anything inside the ventilation slots.
- 5 It is important that your touchmonitor remains dry. Do not pour liquid into or onto your touchmonitor. If your touchmonitor becomes wet do not attempt to repair it yourself.

Care and Handling of Your Touchmonitor

The following tips will help keep your touchmonitor functioning at the optimal level.

- To avoid risk of electric shock, do not disassemble the brick supply or display unit cabinet. The unit is not user serviceable. Remember to unplug the display unit from the power outlet before cleaning.
- Do not use alcohol (methyl, ethyl or isopropyl) or any strong dissolvent. Do not use thinner or benzene, abrasive cleaners or compressed air.
- To clean the display unit cabinet, use a cloth lightly dampened with a mild detergent.
- Avoid getting liquids inside your touchmonitor. If liquid does get inside, have a qualified service technician check it before you power it on again.
- Do not wipe the screen with a cloth or sponge that could scratch the surface.
- To clean the touchscreen, use window or glass cleaner. Put the cleaner on a clean cloth and wipe the touchscreen. Never apply the cleaner directly on the touchscreen.



Warning

This product consists of devices that may contain mercury, which must be recycled or disposed of in accordance with local, state, or federal laws. (Within this system, the backlight lamps in the monitor display contain mercury.)



Waste Electrical and Electronic Equipment (WEEE) Directive

In the European Union, this label indicates that this product should not be disposed of with household waste. It should be deposited at an appropriate facility to enable recovery and recycling.

C

TECHNICAL SPECIFICATIONS

Touchmonitor Specifications

Model	1938L	
LCD Display	19" TFT Active Matrix Panel	
Display Size	408(H) x 255(V) mm	
Pixel Pitch	0.284(H) x 0.284(V) mm	
Display Mode	VGA 640 x 350 (70Hz) VGA 720 x 400 (70Hz) VGA 640 x 480 (60 / 66 / 72Hz) SGA 800 x 600 (56 / 60 / 72Hz) XGA 1024 x 768 (60 / 65 / 72Hz) SXGA 1280 x 1024 (60 / 75Hz) 1440 x 900 (60Hz) 1152 x 864 (75Hz) 1280 x 768 (65Hz) 1680 x 1050 (60Hz) 1366 x 768 (60Hz) 1280 x 960 (60Hz) 832 x 624 (75Hz) 1280 x 768 (60Hz / 75Hz) 1360 x 768 (60Hz)	
Max. Resolution	WXGA 1440 x 900 (60Hz)	
Contrast Ratio	1000 : 1 (typical)	
Brightness	No touch screen: typical 230 cd/m ² ; Min 184 cd/m ² IntelliTouch: typical 230 cd/m ² ; Min 184 cd/m ² Surface Capacitive: typical 212 cd/m ² ; Min 170 cd/m ² SecureTouch: typical 230 cd/m ² ; Min 184 cd/m ² Acoustic Pulse Recognition: typical 230 cd/m ² ; Min 184 cd/m ²	
Response Time	Tr: 15 ms Tf: 7ms (Typ.)	
Display Color	16.7M	
Viewing Angle	Vertical -89° ~ +89° Horizontal -89° ~ +89°	
Input Signal	Video	R.G.B. Analog 0.7Vp-p, 75 ohm
	Sync	TTL Positive or Negative
	DVI video	Digital TMDS Input
Signal Connector	Mini D-Sub 15 pin, DVI-D	
Rear Controls	Menu, ◀, ▶, Select, Power	
On Screen Display (OSD) Controls	Contrast, Brightness, H-Position, V-Position, Color Temperature, Phase, Clock, OSD Time, Recall, Language: English, French, German, Spanish, Japanese, Korean, Italian, Traditional Chinese, Simplified Chinese	
Plug & Play	DDC 2B	
Touch Panel (optional)	IntelliTouch//Surface Capacitive/SecureTouch/APR	
Power Adapter	Input AC 100-240V, 50/60Hz	
Operating Conditions	Temperature	0°C ~ 40°C (32°F ~ 104°F)
	Humidity	20% ~ 80% (No Condensation)
	Altitude	To 12,000 Feet
Storage Conditions	Temperature	-20°C ~ 60°C (-4°F ~ 140°F)
	Humidity	10% ~ 90% (No Condensation)
Dimensions (HxWxD)	297 x 444 x 47 mm	
Weight (Net)	4.75Kg	
Certifications	UL, C-UL, FCC-B, CE, VCCI, C-Tick, MPRII, TUV T Mark EK, ETC, CCC, BSMI	

Note: DVI is not included on EU models

IntelliTouch Touchscreen Specifications

Positional Accuracy	Standard deviation of error is less than 0.080 in. (2.03 mm). Equates to less than $\pm 1\%$.
Touchpoint Density	More than 100,000 touchpoints/in ² (15,500 touchpoints/cm ²).
Touch Activation Force	Typically less than 3 ounces (85 grams).
Surface Durability	Surface durability is that of glass, Mohs' hardness rating of 7.
Expected Life Performance	No known wear-out mechanism, as there are no layers, coatings, or moving parts. IntelliTouch technology has been operationally tested to more than 50 million touches in one location without failure, using a stylus similar to a finger.
Sealing	Unit is sealed to protect against splashed liquids, dirt, and dust.
Light Transmission (per ASTM D1003)	90%
Visual Resolution	All measurements made using USAF 1951 Resolution Chart, under 30X magnification, with test unit located approximately 1.5 in (38 mm) from surface of resolution chart. Clear surface: Excellent, with no noticeable degradation. Antiglare surface: 6:1 minimum.
Gloss (per ASTM D2457 using a 60-degree gloss meter)	Antiglare surface: Curved: 60 ± 20 gloss units or 75 ± 15 gloss units.
Chemical Resistance	The active area of the touchscreen is resistant to all chemicals that do not affect glass, such as: Acetone Toluene Methyl ethyl ketone Isopropyl alcohol Methyl alcohol Ethyl acetate Ammonia-based glass cleaners Gasoline Kerosene Vinegar
Electrostatic Protection (per EN 61 000-4-2, 1995)	Meets Levels 4 (15kV air/8 kV contact discharge)

Surface Capacitive Touchscreen Specifications

Input method	Finger
Glass Thickness	0.118" / 3.0 mm nominal. (Glass only, not including tape, wires and/or solder if used)
Positional Accuracy	Reported touch coordinates are within 1.5% of true position (based on viewing area dimensions)
Resolution	Touchpoint density is based on controller resolution of 4096 x 4096
Controller	Controller board size of 2.1" x 3.3" (5.4 x 8.4 cm), with auto-detect function for Serial (RS232) and USB 1.1 connection
OPTICAL	Up to 85% per ASTM D1003
Temperature	Touchscreen Operating: -15°C to 70°C Storage: -50°C to 85°C Controller Operating: 0°C to 65°C Storage: -25°C to 85°C
Relative Humidity	Operating/Storage: 10% to 90% RH, noncondensing
Chemical Resistance	Water, ammonia, isopropyl alcohol, and similar non-abrasive cleaners
Agency Approvals	UL, cUL, TUV, CE, FCC Class A & B, CISPR B
Sealability	Can be sealed to meet NEMA 4 and 12 and IP 65 standards
Surface Durability	Anti-glare hardcoat cannot be scratched using any stylus with Mohs rating equal to or less than 6. Tested in the laboratory to withstand over 160 million (mechanically simulated) touches without noticeable degradation.

SecureTouch Touchscreen Specifications

Input Method	Finger or gloved hand (cloth, leather, or rubber) activation
Positional Accuracy	Standard deviation of error is less than 0.080 in. (2 mm)
Resolution	Touchpoint density is based on controller resolution of 4096 x 4096, plus 255 levels corresponding to touch pressure
Touch Activation Force	Typically 2 to 3 ounces (55 to 85 grams)
Controller	Board: Serial (RS232) or USB 1.1
Light Transmission	Up to 90% per ASTM D1003-92
Temperature	Operating: -20° C to 50° C Storage: -40° C to 71° C
Relative Humidity	Operating: 40° C at 90% RH, noncondensing
Altitude	Operating: 10,000 ft (3,048 m) Storage/transport: 50,000 ft (15,240 m)
Chemical Resistance	The touch active area of the touchscreen is resistant to chemicals that do not affect glass, such as: acetone, toluene, methyl ethyl ketone, isopropyl alcohol, methyl alcohol, ethyl acetate, ammonia-based glass cleaners, gasoline, kerosene, vinegar
Electrostatic Protection	Per EN 6100-4-2, 1995: Meets Level 4 (15 kV air/8 kV contact discharges)
Agency Approvals	UL, cUL, TUV, CE, FCC Class A
Sealability	Can be sealed to meet NEMA 3/3R/5/12/12K/13, IP64 standards
Surface Durability	Surface durability is that of glass, Mohs' hardness rating of 7
Expected Life	No known wear-out mechanism, as there are no layers, coatings, or moving parts. SecureTouch technology has been operationally tested to more than 50 million touches in one location without failure, using a stylus similar to a finger.
Impact Resistance	Meets UL-60950 and CSA 22.2 No. 60950 ball drop test (0.5 kg, 50 mm diameter ball dropped from height of 1.3 m)

Acoustic Pulse Recognition Specification

Input method	Finger, finger nail, gloved hand, or stylus activation
Position accuracy	1% max. error
Resolution accuracy	Touchpoint density is based on controller resolution of 4096 x 4096
Touch activation force	Typically 2 to 3 ounces (55 to 85 grams)
Controller	Board: USB 1.1
Light transmission	90% +/-5%
Chemical resistance	The touch activation area of the touchscreen is resistant to chemicals that do not affect glass such as: acetone, toluene, methyl ethyl ketone, isopropyl alcohol, methyl alcohol, ethyl acetate, ammonia-based glass cleaners, gasoline, kerosene, vinegar
Surface durability	Surface durability is that of glass, Mohs' hardness rating of 7
Expected life	No known wear-out mechanism, as there are no layers, coatings, or moving parts. APR technology has been operationally tested to more than 50 million touches in one location without failure, using a stylus similar finger.

19" LCD Touchmonitor (ET1938L-XXA-X-G) Dimensions

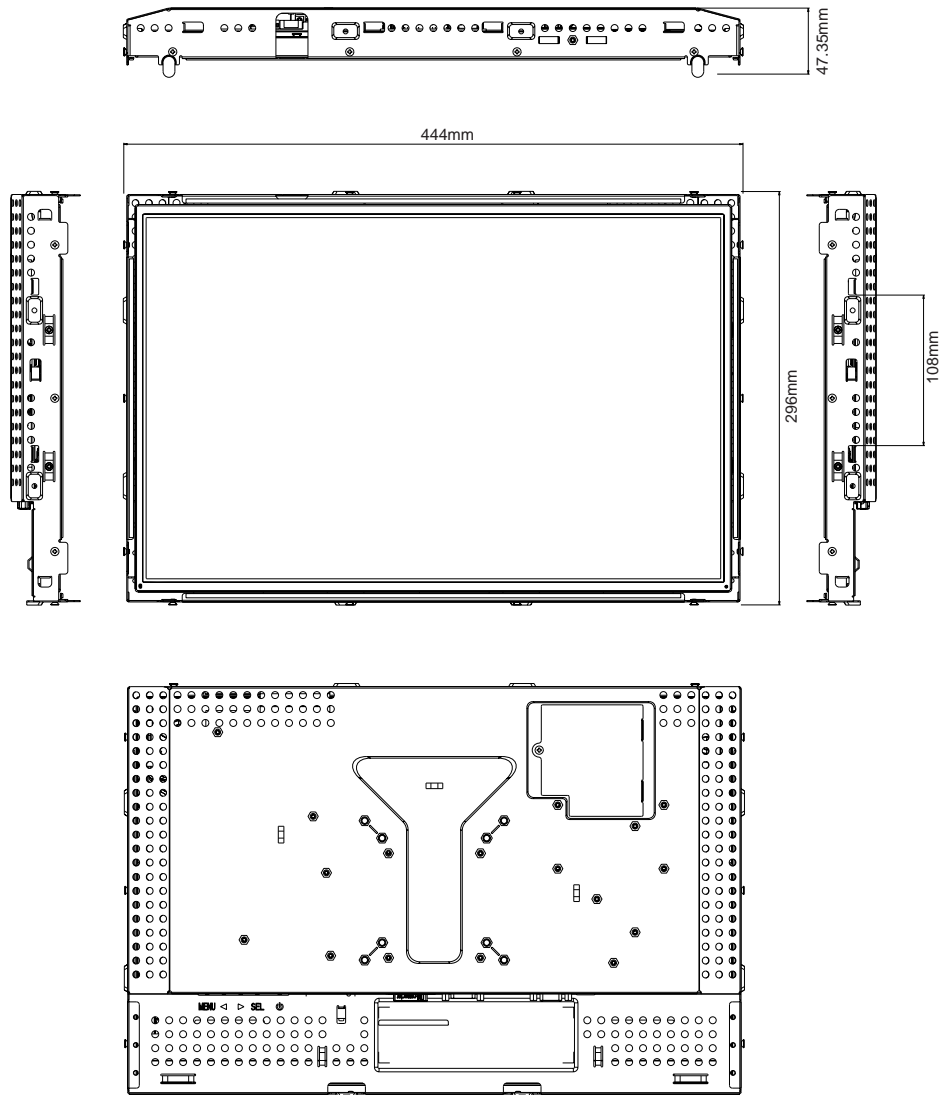

REGULATORY INFORMATION

I. Electrical Safety Information:

A) Compliance is required with respect to the voltage, frequency, and current requirements indicated on the manufacturer's label. Connection to a different power source than those specified herein will likely result in improper operation, damage to the equipment or pose a firehazard if the limitations are not followed.

B) There are no operator serviceable parts inside this equipment. There are hazardous voltages generated by this equipment which constitute a safety hazard. Service should be provided only by a qualified service technician.

C) This equipment is provided with a detachable power cord which has an integral safety ground wire intended for connection to a grounded safety outlet.

- 1) Do not substitute the cord with other than the provided approved type. Under no circumstances use an adapter plug to connect to a 2-wire outlet as this will defeat the continuity of the grounding wire.
- 2) The equipment requires the use of the ground wire as a part of the safety certification, modification or misuse can provide a shock hazard that can result in serious injury or death.
- 3) Contact a qualified electrician or the manufacturer if there are questions about the installation prior to connecting the equipment to mains power.

II. Emissions and Immunity Information

A) Notice to Users in the United States: This equipment has been tested and found to comply with the limits for a Class B digital device, pursuant to Part 15 of FCC Rules. These limits are designed to provide reasonable protection against harmful interference in a residential installation. This equipment generates, uses, and can radiate radio frequency energy, and if not installed and used in accordance with the instructions, may cause harmful interference to radio communications.

B) Notice to Users in Canada: This equipment complies with the Class B limits for radio noise emissions from digital apparatus as established by the Radio Interference Regulations of Industrie Canada.

C) Notice to Users in the European Union: Use only the provided power cords and interconnecting cabling provided with the equipment. Substitution of provided cords and cabling may compromise electrical safety or CE Mark Certification for emissions or immunity as required by the following standards:

This Information Technology Equipment (ITE) is required to have a CE Mark on the manufacturer's label which means that the equipment has been tested to the following Directives and Standards:

This equipment has been tested to the requirements for the CE Mark as required by EMC Directive 89/336/EEC indicated in European Standard EN 55022 Class B and the Low Voltage Directive 73/23/EEC as indicated in European Standard EN 60950.

D) General Information to all Users: This equipment generates, uses and can radiate radio frequency energy. If not installed and used according to this manual the equipment may cause interference with radio and television communications. There is, however, no guarantee that interference will not occur in any particular installation due to site-specific factors.

- 1) In order to meet emission and immunity requirements, the user must observe the following:
 - a) Use only the provided I/O cables to connect this digital device with any computer.
 - b) To ensure compliance, use only the provided manufacturer's approved line cord.
 - c) The user is cautioned that changes or modifications to the equipment not expressly approved by the party responsible for compliance could void the user's authority to operate the equipment.
- 2) If this equipment appears to cause interference with radio or television reception, or any other device:
 - a) Verify as an emission source by turning the equipment off and on.
 - b) If you determine that this equipment is causing the interference, try to correct the interference by using one or more of the following measures:
 - i) Move the digital device away from the affected receiver.
 - ii) Reposition (turn) the digital device with respect to the affected receiver.
 - iii) Reorient the affected receiver's antenna.
 - iv) Plug the digital device into a different AC outlet so the digital device and the receiver are on different branch circuits.
 - v) Disconnect and remove any I/O cables that the digital device does not use. (Unterminated I/O cables are a potential source of high RF emission levels.)
 - vi) Plug the digital device into only a grounded outlet receptacle. Do not use AC adapter plugs. (Removing or cutting the line cord ground may increase RF emission levels and may also present a lethal shock hazard to the user.)

If you need additional help, consult your dealer, manufacturer, or an experienced radio or television technician.

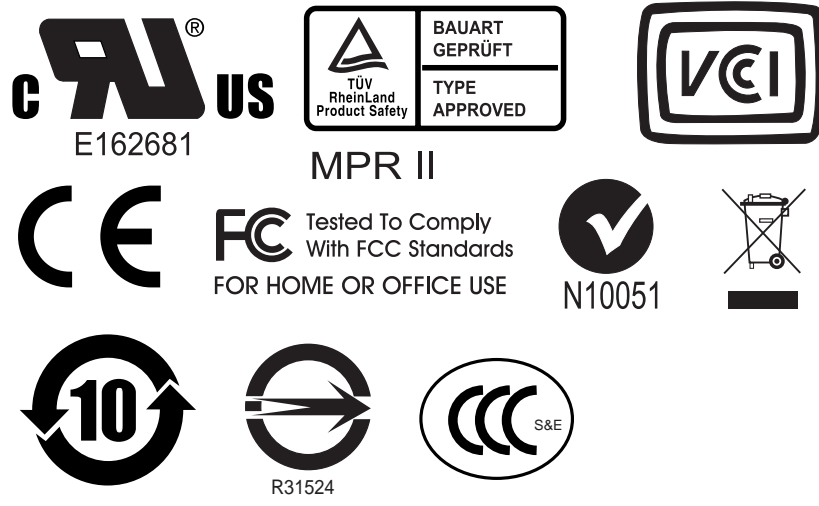

This class B digital apparatus meets all requirements of the Canadian Interference-Causing Equipment Regulations.

Cet appareil numérique de la classe B respecte toutes les exigences du Règlement sur le matériel brouilleur du Canada.

This device complies with Part 15 of the FCC Rules. Operation is subject to the following two conditions: (1) This device may not cause harmful interference, and (2) This device must accept any interference received, including interference that may cause undesired operation.

WARRANTY

Except as otherwise stated herein or in an order acknowledgment delivered to Buyer, Seller warrants to Buyer that the Product shall be free of defects in materials and workmanship. The warranty for the touchmonitors and components of the product is regional; please contact your regional office.

Seller makes no warranty regarding the model life of components. Seller's suppliers may at any time and from time to time make changes in the components delivered as Products or components.

Buyer shall notify Seller in writing promptly (and in no case later than thirty (30) days after discovery) of the failure of any Product to conform to the warranty set forth above; shall describe in commercially reasonable detail in such notice the symptoms associated with such failure; and shall provide to Seller the opportunity to inspect such Products as installed, if possible. The notice must be

received by Seller during the Warranty Period for such product, unless otherwise directed in writing by the Seller. Within thirty (30) days after submitting such notice, Buyer shall package the allegedly defective Product in its original shipping carton(s) or a functional equivalent and shall ship to Seller at Buyer's expense and risk.

Within a reasonable time after receipt of the allegedly defective Product and verification by Seller that the Product fails to meet the warranty set forth above, Seller shall correct such

failure by, at Seller's options, either (i) modifying or repairing the Product or (ii) replacing the Product. Such modification, repair, or replacement and the return shipment of the Product with minimum insurance to Buyer shall be at Seller's expense. Buyer shall bear the risk of loss or damage in transit, and may insure the Product. Buyer shall reimburse Seller for transportation cost incurred for Product returned but not found by Seller to be defective. Modification or repair, of Products may, at Seller's option, take place either at Seller's facilities or at Buyer's premises. If Seller is unable to modify, repair, or replace a Product to conform to the warranty set forth above, then Seller shall, at Seller's option, either refund to Buyer or credit to Buyer's account the purchase price of the Product less depreciation calculated on a straight-line basis over Seller's stated Warranty Period.

THESE REMEDIES SHALL BE THE BUYER'S EXCLUSIVE REMEDIES FOR BREACH OF WARRANTY. EXCEPT FOR THE EXPRESS WARRANTY SET FORTH ABOVE, SELLER GRANTS NO OTHER WARRANTIES, EXPRESS OR IMPLIED BY STATUTE OR OTHERWISE, REGARDING THE PRODUCTS, THEIR FITNESS FOR ANY PURPOSE, THEIR QUALITY, THEIR MERCHANTABILITY, THEIR NONINFRINGEMENT, OR OTHERWISE. NO EMPLOYEE OF SELLER OR ANY OTHER PARTY IS AUTHORIZED TO MAKE ANY WARRANTY FOR THE GOODS OTHER THAN THE WARRANTY SET FORTH HEREIN. SELLER'S LIABILITY UNDER THE WARRANTY SHALL BE LIMITED TO A REFUND OF THE PURCHASE PRICE OF THE PRODUCT. IN NO EVENT SHALL SELLER BE LIABLE FOR THE COST OF PROCUREMENT OR INSTALLATION OF SUBSTITUTE GOODS BY BUYER OR FOR ANY SPECIAL, CONSEQUENTIAL, INDIRECT, OR INCIDENTAL DAMAGES.

Buyer assumes the risk and agrees to indemnify Seller against and hold Seller harmless from all liability relating to (i) assessing the suitability for Buyer's intended use of the Products and of any system design or drawing and (ii) determining the compliance of Buyer's use of the Products with applicable laws, regulations, codes, and standards. Buyer retains and accepts full responsibility for all warranty and other claims relating to or arising from Buyer's products, which include or incorporate Products or components manufactured or supplied by Seller. Buyer is solely responsible for any and all representations and warranties regarding the Products made or authorized by Buyer. Buyer will indemnify Seller and hold Seller harmless from any liability, claims, loss, cost, or expenses (including reasonable attorney's fees) attributable to Buyer's products or representations or warranties concerning same.



INDEX



A

About the Product, 8
About Touchmonitor Adjustments, 17
Acoustic Pulse Recognition Specification, 35

B

Brightness, 29

C

Care and Handling of Your Touchmonitor, 27
Certifications, 29
Cleaning Your Touchmonitor, 27
Contrast Ratio, 29
Controls and Adjustment, 19

D

Dimensions (HxWxD), 29
Display Color, 29
Display Mode, 29
Display Size, 29

E

Electrical Safety Information, 32
Emissions and Immunity Information, 35

F

Front View, 10

I

Image problem, 23
Image, scrolling, 23
Input Signal, 29
Installing APR USB Touch Driver for Windows XP, 16
Installation and Setup, 9
Installing the Driver Software, 12
Installing the Serial Touch Driver, 13

Installing the Serial Touch Driver for MS-DOS and
Windows 3.1, 14

Installing the Serial Touch Driver for Windows XP,
Windows 2000, Me, 95/98 and NT 4.0, 13

Installing the USB Touch Driver, 15

Installing the USB Touch Driver for Windows XP,
Windows 2000, Me, 95/98 and NT 4.0, 15

IntelliTouch Touchscreen Specifications, 30

M

Main Unit, 10
Max. Resolution, 29

N

Native Resolution, 24

O

Operating Conditions, 29
On Screen Display (OSD), 29
OSD Control Options, 20
OSD Menu Functions, 19

P

Pixel Pitch, 29
Plug & Play, 29
Power Adapter, 29
Power Management System, 22
Precautions, 7
Product Description, 7
Product Overview, 10

R

Rear Control, 29
Rear View, 10
Rear Panel Controls, 18
Regulatory Information, 32
Remote OSD Buttons(option), 18
Response Time, 29

S

SecureTouch Touchscreen Specifications, 32
Signal Connector, 29
Solutions to Common Problems, 22
Storage Conditions, 29
Surface Capacitive Touchscreen Specifications, 31
SVGA, 24
SXGA, 24

T

Technical Specifications, 28
Touch Interface Connection, 11
Touch not working, 23
Touch Panel (optional), 29
Touchmonitor Safety, 26
Touchmonitor Specifications, 29
Troubleshooting, 23

U

Unpacking Your Touchmonitor, 9
UXGA, 24

V

VGA, 24
Viewing Angle, 29

W

Warranty, 36
Weight (Net), 29

X

XGA, 24

Check out Elo's Web site!

www.elotouch.com

Get the latest...

• **Product information**

• **Specifications**

• **News on upcoming events**

• **Press release**

• **Software drivers**

• **Touchmonitor Newsletter**

Getting in Touch with Elo

To find out more about Elo's extensive range of touch solutions, visit our Web site at www.elotouch.com or simply call the office nearest you:

North America

Elo TouchSystems
301 Constitution Drive,
Menlo Park, CA 94025
USA

(800) ELO-TOUCH
(800-356-8682)
Tel 650-361-4800
Fax 650-361-4722
customerservice@elotouch.com

Germany

Tyco Electronics Raychem GmbH
(Elo TouchSystems Division)
Finsinger Feld 1
D-85521 Ottobrunn
Germany

Tel +49(0)(89)60822-0
Fax +49(0)(89)60822-180
elosales@elotouch.com

Belgium

Tyco Electronics Raychem GmbH
(Elo TouchSystems Division)
Diestsesteenweg 692
B-3010 Kessel-Lo
Belgium

Tel +32(0)(16)35-2100
Fax +32(0)(16)35-2101
elosales@elotouch.com

Asian-Pacific

Sun Homada Bldg. 2F
1-19-20 Shin-Yokohama
Kanagawa 222-0033
Japan

Tel +81(45)478-2161
Fax +81(45)478-2180
www.tps.co.jp