Gladius G0975/0975M

9.7” Intel® Celeron® N2930

Rugged Tablet PC

User's Manual

Version 1.3

This page is intentionally left blank.

Revision History

Version	Date	Descriptions
1.0	2015.03	Initial release
1.1	2016.11	1.3 Specifications : Updated to the latest specifications New sections: A. Using the Vehicle Cradle (Optional) B. Using the Desktop Cradle (Optional)
1.2	2017.01	Added new model (G0975M) descriptions
1.3	2017.10	1.3 Specifications : Remove Gyroscope and G0975S-related information Added rear camera information for G0975M A.3 Specifications : Added 5V output description for VMC-0975's RS-232 specification in Added RS-232 port pin assignment for VMC-0975 B. Using the Desktop Cradle (Optional) : Added DTC-0975M related descriptions

Copyright

Copyright © 2017 ARBOR Technology Corp. All Rights Reserved.

This document contains proprietary information protected by copyright. No part of this manual may be reproduced by any mechanical, electronic, or other means in any form without prior written permission of the manufacturer.

Disclaimer

The information in this document is subject to change without prior notice in order to improve the reliability, design and function. It does not represent a commitment on the part of the manufacturer.

Under no circumstances will the manufacturer be liable for any direct, indirect, special, incidental, or consequential damages arising from the use or inability to use the product or documentation, even if advised of the possibility of such damages.

About This Manual

This user's manual provides the general information and installation instructions for the product. The manual is meant for the experienced users and integrators with hardware knowledge of personal computers. If you are not sure about any description in this manual, consult your vendor before further handling.

We recommend that you keep one copy of this manual for the quick reference for any necessary maintenance in the future. Thank you for choosing ARBOR products.

Contents

Preface	vii
Declaration of Conformity	vii
CE	vii
FCC Class B	vii
RoHS	viii
SVHC / REACH	viii
Symbols Description	ix
Important Safety Instructions	ix
Rechargeable Battery Pack Safety	xi
General Cleaning Tips	xii
Cleaning Tools	xiii
Recommended Cleaning Procedures	xiii
Disposing of the Computer	xiv
Additional Information & Technical Support	xv
Warranty	xvi
Chapter 1. Introduction	1
1.1 Product Highlights.....	2
1.2 Package Contents	3
1.2.1 Order Information.....	3
1.2.2 Optional Accessories	4
1.2.3 Configure-to-Order Service	4
1.3 Specifications.....	4
1.3.1 G0975	4
1.3.2 G0975M	7
1.4 Dimensions	10
1.4.1 G0975	10
1.4.2 G0975M	11
Chapter 2. Getting Started	13
2.1 Getting to Know the Computer	14
2.1.1 Front Side	14
2.1.2 Left and Right Sides.....	18
2.1.3 Bottom Side	20
2.1.4 Rear Side	20
2.2 Installing Memory Card.....	21
2.3 Installing/Replacing the External Battery Pack	21
2.4 Charging the Battery Pack.....	24

Important Notice on Charging the Battery	24
2.5 Driver Installation	25
Notice on USB Hub Driver	28
Chapter 3. Using the Computer.....	31
3.1 Using Touch Screen.....	32
3.1.1 Projected Capacitive Touch	32
3.1.2 Text Input	32
3.1.2.1 On-screen Keyboard	32
3.1.2.2 Handwriting Recognition	33
3.2 Function Keys.....	34
3.2.1 Using the Function Keys.....	34
3.2.2 Customizing the Function Keys	34
3.3 Using the Wi-Fi Feature.....	36
3.4 Using the Bluetooth Feature	38
3.4.1 Launching the Bluetooth Feature.....	38
3.4.2 Pairing/Connecting with Other Bluetooth Devices	39
3.4.3 Bluetooth Device Name	40
3.4.4 Hiding/Exposing the Computer	40
3.5. Using the Camera (for G0975 Only).....	42
3.5.1 Launching the Camera.....	42
3.5.2 Taking a Picture	43
3.5.3 Shooting a Video.....	43
3.5.4 Configuring Video Shooting	43
Chapter 4. Utilities	45
4.1 ARBOR System Suite	46
4.1.2 Accessing ARBOR System Suite	46
4.1.3 Using ARBOR System Suite	47
Chapter 5. BIOS	49
5.1 Accessing the BIOS Setup Utility.....	50
5.2 Main Setup.....	51
5.3 Advanced Settings.....	52
5.3.1 Boot Configuration	53
5.3.2 PCI Express Configuration.....	53
5.3.3 Miscellaneous Configuration.....	54
5.3.4 Thermal Configuration	54
5.3.5 SATA Configuration	55
5.4 Security Settings.....	56
5.5 Power Settings	57

5.6 Boot Settings	58
5.7 Exit Options	59
Appendix	61
A. Using the Vehicle Cradle (Optional)	62
A.1 Overview.....	62
A.2 Dimensions.....	63
A.3 Specifications	64
A.4 Installing the Vehicle Cradle	65
A.4.1 Docking the G0975 to the Vehicle Cradle.....	65
A.4.2 Installing the Vehicle Cradle Driver	67
A.4.3 Mounting the Cradle to a Vehicle	72
A.4.4 Connecting the Peripherals to the Cradle	73
A.5 Removing the G0975 from the Vehicle Cradle	73
B. Using the Desktop Cradle (Optional).....	75
B.1 Overview.....	75
B.2 Specifications	76
B.3 Dimensions	77
B.4 Installing the Desktop Cradle.....	78
B.4.1 Docking the G0975 to the Desktop Cradle	78
B.4.2 Installing the Desktop Cradle Driver	79

This page is intentionally left blank.

Declaration of Conformity

CE

The CE symbol on your product indicates that it is in compliance with the directives of the Union European (EU). A Certificate of Compliance is available by contacting Technical Support.

This product has passed the CE test for environmental specifications when shielded cables are used for external wiring. We recommend the use of shielded cables. This kind of cable is available from ARBOR. Please contact your local supplier for ordering information.

FCC Class B

This device complies with Part 15 of the FCC Rules. Operation is subject to the following two conditions:

1. This device may not cause harmful interference, and
2. This device must accept any interference received, including interference that may cause undesired operation.

Any changes or modifications not expressly approved by the guarantee of this device could void the user's authority to operate the equipment.

This equipment has been tested and found to comply with the limits for a Class B digital device, pursuant to Part 15 of the FCC Rules. These limits are designed to provide reasonable protection against harmful interference in a residential installation. This equipment generates, uses and can radiate radio frequency energy and, if not installed and used in accordance with the instructions, may cause harmful interference to radio communications.

However, there is no guarantee that interference will not occur in a particular installation. If this equipment does cause harmful interference to radio or television reception, which can be determined by turning the equipment off and on, the user is encouraged to try to correct the interference by one or more of the following measures:

- Reorient or relocate the receiving antenna.
- Increase the separation between the equipment and receiver.

- Connect the equipment into an outlet on a circuit different from that to which the receiver is connected.
- Consult the dealer or an experienced radio/TV technician for help.

RoHS

ARBOR Technology Corp. certifies that all components in its products are in compliance and conform to the European Union's Restriction of Use of Hazardous Substances in Electrical and Electronic Equipment (RoHS) Directive 2002/95/EC.

The above mentioned directive was published on 2/13/2003. The main purpose of the directive is to prohibit the use of lead, mercury, cadmium, hexavalent chromium, polybrominated biphenyls (PBB), and polybrominated diphenyl ethers (PBDE) in electrical and electronic products. Member states of the EU are to enforce by 7/1/2006.

ARBOR Technology Corp. hereby states that the listed products do not contain unintentional additions of lead, mercury, hex chrome, PBB or PBDB that exceed a maximum concentration value of 0.1% by weight or for cadmium exceed 0.01% by weight, per homogenous material. Homogenous material is defined as a substance or mixture of substances with uniform composition (such as solders, resins, plating, etc.). Lead-free solder is used for all terminations (Sn(96-96.5%), Ag(3.0-3.5%) and Cu(0.5%)).

SVHC / REACH

To minimize the environmental impact and take more responsibility to the earth we live, ARBOR hereby confirms all products comply with the restriction of SVHC (Substances of Very High Concern) in (EC) 1907/2006 (REACH --Registration, Evaluation, Authorization, and Restriction of Chemicals) regulated by the European Union.

All substances listed in SVHC < 0.1 % by weight (1000 ppm)

Symbols Description



This symbol of “CAUTION” indicates that there is a danger of injury to the user or a risk of damage to the product, should warning notices be disregarded.



Battery Recycle



This symbol indicates electrical warning.



Change of electric current:
Internal: positive current
External: negative current

Important Safety Instructions

Read these safety instructions carefully:

1. Read all cautions and warnings on the equipment.
2. Place this equipment on a reliable surface when installing. Dropping it or letting it fall may cause damage.
3. Make sure the correct voltage is connected to the equipment.
4. For pluggable equipment, the socket outlet should be near the equipment and should be easily accessible.
5. Keep this equipment away from humidity.
6. Disconnect this equipment from the A/C outlet before cleaning it. Use a moist cloth. Do not use liquid or sprayed detergent for cleaning.
7. To fully disengage the power to the unit, please disconnect the power from the AC outlet.
8. Do not scratch or rub the screen with a hard object.

9. Never use any of the solvents, such as Thinner Spray-type cleaner, Wax, Benzene, Abrasive cleaner, Acid or Alkaline solvent, on the display. Harsh chemicals may cause damage to the cabinet and the touch sensor.
10. Remove dirt with a lightly moistened cloth and a mild solvent detergent. Then wipe the cabinet with a soft dry cloth.
11. The openings on the enclosure are for air convection and protect the equipment from overheating. **DO NOT COVER THE OPENINGS.**
12. Position the power cord so that people cannot step on it. Do not place anything over the power cord.
13. If the equipment will not be used for a long time, disconnect it from the power source to avoid damage by transient overvoltage.
14. Never pour any liquid into openings. This may cause fire or electrical shock.
15. Never open the equipment. For safety reasons, the equipment should be opened only by qualified service personnel.
16. If one of the following situations arises, get the equipment checked by service personnel:
 - a. The power cord or plug is damaged.
 - b. Liquid has penetrated into the equipment.
 - c. The equipment has been exposed to moisture.
 - d. The equipment does not work well, or you cannot get it to work according to the user's manual.
 - e. The equipment has been dropped or damaged.
 - f. The equipment has obvious signs of breakage.
17. The sound pressure level at the operator's position, according to IEC 704-1:1982, is no more than 70dB(A).
18. Keep this User's Manual for later reference.
19. **DO NOT LEAVE THIS EQUIPMENT IN AN UNCONTROLLED ENVIRONMENT WHERE THE STORAGE TEMPERATURE IS BELOW**

-20° C (-4° F) OR ABOVE 60° C (140° F). THIS MAY DAMAGE THE EQUIPMENT.

Rechargeable Battery Pack Safety

- **Important Terms to Understand**

“Battery life” means the time the equipment will run before it must be recharged (sometimes this is also called “playtime” or “runtime”).

“Battery lifespan” means the total amount of time your battery will last before it must be replaced.

- **Using the Equipment for the First Time**

Be sure to fully charge (approx. 4 hours) the equipment when charging the equipment for the first time.

- **Long-Term Storage & Maintenance**

If you are putting away the battery for more than three months, it is recommended that the battery should be stored separately and fully charged, and get recharged every three months. If you store an uncharged battery, it could fall into a deep worn-out state which would render it incapable of holding any charge. Be sure to store the equipment and battery at the proper temperature.

- **Battery Lifespan**

The removable batteries for the equipment are designed to retain up to 80% of their original capacity after 300 charging and recharging cycles when properly maintained. You may choose to purchase new battery when it no longer holds the sufficient charge that meets your needs.

- The lithium-ion battery is currently one of the most popular battery packs. The best advantage is that it has no memory effect, so users needn't worry about that issue. Users can charge the battery anytime whether it is fully drained or not. However, it's recommended that users drain the battery until the system shows power shortage warning and then recharge the battery. Doing so is helpful to the reliability of your battery.
- Don't use the battery pack as a power supply for other equipment.
- Don't expose the battery to elevated heat situations such as under direct sunlight in a car or near fire.

- Don't disassemble the battery, or the battery leakage might cause skin or eye injury. If electrolyte leaking from the battery contacts your skin or clothing, immediately flush it with running water. If it splashes into eye, rinse the eye at least 15 minutes with clean water and then seek medical attention.
- To avoid battery leakage or explosion, don't discard the battery into water or fire, or put them near a heat source such as a gas stove or an oven.
- If you are putting away the battery for more than three months, it is recommended that the battery should be stored separately and fully charged, and get recharged every three months. If you store an uncharged battery, it could fall into a deep worn-out state which would render it incapable of holding any charge. Be sure to store your the equipment and battery at the proper temperature.
- Use the appropriate container to store the battery such as a paper box. Do not allow a metal object to touch the terminal of the battery.
- The battery consists of precise electrical components and cells. Do not drop or hit the battery.

General Cleaning Tips

You may need the following precautions before you begin to clean the device. When you clean any single part or component for the device, please thoroughly read and understand the details below.

1. We strongly recommended that you should shut down the system before you start to clean any single components.
2. When you need to clean the device, please rub it with a piece of dry cloth.
3. Be cautious of the tiny removable components when you use a vacuum cleaner to absorb the dirt on the floor.
4. Never drop the components inside the device or get circuit board damp or wet.
5. Be cautious of all kinds of cleaning solvents or chemicals when you use it for the sake of cleaning. Some individuals may be allergic to the ingredients.
6. Try not to put any food, drink or cigarette around the device.

Cleaning Tools

Although many companies have created products to help improve the process of cleaning your devices and peripherals, users can also use household items to clean their devices and peripherals. Below is a listing of items you may need or want to use while cleaning your devices or peripherals. Keep in mind that some components in your device may only be able to be cleaned using a product designed for cleaning that component, if this is the case it will be mentioned in the cleaning.

- **Cloth:** A piece of cloth is the best tool to use when rubbing up a component. Although paper towels or tissues can be used on most hardware as well, we still recommend you to rub it with a piece of cloth.
- **Water or rubbing alcohol:** You may moisten a piece of cloth a bit with some water or rubbing alcohol and rub it on the device. Unknown solvents may be harmful to the plastics parts.
- **Vacuum cleaner:** Absorb the dust, dirt, hair, cigarette particles, and other particles out of the device can be one of the best cleaning methods. Over time, these items can restrict the airflow in a device and cause circuitry to corrode.
- **Cotton swabs:** Cotton swabs moistened with rubbing alcohol or water are excellent tools for wiping hard to reach areas in your keyboard, mouse, and other locations.
- **Foam swabs:** Whenever possible, it is better to use lint-free swabs such as foam swabs.

Recommended Cleaning Procedures

1. Close all application programs
2. Close operating software
3. Turn off power switch
4. Remove all peripherals
5. Pull out power cable

Disposing of the Computer

- **Within the European Union**



EU-wide legislation, as implemented in each Member State, requires that waste electrical and electronic products carrying the mark (left) must be disposed of separately from normal household waste.

This includes monitors and electrical accessories, such as signal cables or power cords. When you need to dispose of your display products, please follow the guidance of your local authority, or ask the shop where you purchased the product, or if applicable, follow any agreements made between yourself. The mark on electrical and electronic products only applies to the current European Union Member States.

- **Outside the European Union**

If you wish to dispose of used electrical and electronic products outside the European Union, please contact your local authority so as to comply with the correct disposal method.

Additional Information & Technical Support

All ARBOR products are built to the most accurate specifications to ensure reliable performance in the harsh and demanding conditions typical of industrial environments. Whether your new equipment is destined for the laboratory or the factory floor, you can be assured that the computer will provide the reliability and ease of operation. Your satisfaction is our primary concern. We want you to get the maximum performance from the computer. So if you run into technical difficulties, we are here to help. For the most frequently asked questions, you can easily find answers in the computer's documentation. These answers are normally a lot more detailed than the ones we can give over the phone. So please consult this manual first. If you still cannot find the answer, gather all the information or questions that apply to your problem, and with the product close at hand, call your dealer. Our dealers are well trained and ready to give you the support you need to get the most from the computer. In fact, most problems reported are minor and are able to be easily solved over the phone. We are always ready to give advice on application requirements or specific information on the installation and operation of any of our products. Do not hesitate to contact us:

Website: www.arbor-technology.com/

E-mail: info@arbor.com.tw

TEL: 886-2-8226-9396

Add: 10F., No.700, Zhongzheng Rd., Zhonghe Dist., New Taipei City 235, Taiwan

Warranty

This product is warranted to be in good working order during the warranty period. Should this product fail to be in good working order at any time during this period, we will, at our option, replace or repair it at no additional charge except as set forth in the following terms. This warranty does not apply to products damaged by misuse, modifications, accident or disaster.

Vendor assumes no liability for any damages, lost profits, lost savings or any other incidental or consequential damage resulting from the use, misuse of, or inability to use this product. Vendor will not be liable for any claim made by any other related party.

Vendors disclaim all other warranties, either expressed or implied, including but not limited to implied warranties of merchantability and fitness for a particular purpose, with respect to the hardware, the accompanying product's manual(s) and written materials, and any accompanying hardware. This limited warranty gives you specific legal rights.

Return authorization must be obtained from the vendor before returned merchandise will be accepted. Authorization can be obtained by calling or faxing the vendor and requesting a Return Merchandise Authorization (RMA) number. Returned goods should always be accompanied by a clear problem description.

Chapter 1

Introduction

1.1 Product Highlights

The G0975 Series is a rugged mobile tablet PC featuring a compact 9.7" XGA IPS LED display and 5MP rear camera (G0975 only). Designed for mobile field applications, the G0975 Series weighs just 1.0 kg and integrates Wi-Fi and Bluetooth wireless connectivity for seamless wireless communication. Compliant with IP65 and MIL-STD-810G shock & vibration standard, the G0975 Series also comes with sealed I/O ports and sturdy rubber bumpers on each of its four corners for enhanced protection. Featuring slim design, high portability and long battery life, the G0975 Series is ideal for mobile POS and logistics application.



G0975



G0975M

- 9.7" XGA IPS LED display with Projected Capacitive Touch
- High computing performance from Intel® Quad Core Celeron®
- Fully rugged for mobile POS or warehousing application
- Meeting MIL-STD-810G, IP65, 4 ft. drop resistance
- High mobility, multiple connectivity (Bluetooth/WLAN)
- Adopting Multi-Touch Screen with Corning® Gorilla® Glass
- Supporting external battery with battery cover
- Providing four function keys and home key

1.2 Package Contents

Upon opening the package, carefully inspect the contents. If any of the items is missing or appears damaged, contact your local dealer or distributor. The package should contain the following items:

1 x G0975/0975M Computer



1 x Driver CD



1 x User's Manual



19V/3.42A 65W AC/DC Adapter Kit



2270mAh 4-Cell External Battery Pack (for G0975)







2270mAh 3-cell external battery pack (for G0975M)



1.2.1 Order Information



G0975	9.7" Intel® Celeron® N2930 rugged tablet PC with XGA LCD, projected capacitive touch, battery pack, WLAN, Bluetooth and Rear Camera
G0975M	9.7" Intel® Celeron® N2930 rugged tablet PC with XGA LCD, projected capacitive touch, battery pack, WLAN and Bluetooth

1.2.2 Optional Accessories

NST-1050	Neck strap, 120 x 4 x 0.6 cm for G105X	
HST-0975	Hand strap, 160 x 30mm	
DTC-0975 DTC-0975M	Desktop Cradle for G0975 series	
VMC-0975	Vehicle cradle for G0975	

1.2.3 Configure-to-Order Service

Make the computer more tailored to your needs by selecting one or more components from the list below to be fabricated to the computer.

IBAT-0975	2270mAh 2-cell Internal Battery Pack (for G0975 only)	
CAM-0975	5.0M rear CMOS camera kit	

1.3 Specifications

1.3.1 G0975

System	
CPU	Intel® Celeron® Processor N2930 quad-core 1.83 GHz
Graphics Controller	Intel® HD Graphics
Memory	2GB DDR3L SO-DIMM memory module installed (optional up to 8GB)
BIOS	UEFI BIOS

Audio	1 x integrated microphone
	2 x piezoelectric speaker
	1 x 3.5 mm headset combo jack
Storage	1 x 32GB MLC mSATA SSD
Peripherals and Devices	
Camera	1 x 5.0 MP rear AF CMOS camera with LED
WLAN & Bluetooth	1 x WLAN 802.11 a/b/g/n & Bluetooth 4.0 LE, class 2
Sensor	Accelerometer, Magnetometer, Light Sensor
I/O Interface	
USB Port	1 x USB 3.0 Type-A port
	1 x USB 2.0 Micro Type-B port
SD Card	1 x microSD/SDHC/SDXC slot
HDMI	1 x Mini HDMI 1.4 port
Docking Port	1 x 8-pin docking connector
Reset	1 x reset button
Button & Indicator	
Function Keys	1 x Home key
	4 x Function keys
Power Button	1 x Power on/off button
LED Indicators	1 x Power LED
	1 x Battery LED
	1 x WLAN LED
	1 x Bluetooth LED
Touch Screen	
Type	10-point Projected Capacitive Touch w/ Corning® Gorilla® Glass
Light Transparency	84.5% (typ.)
Controller Interface	USB interface
LCD Display	
Size/Type	9.7" XGA IPS LED display
Max. Resolution	1024x768 (XGA), w/ 262,144 colors

Luminance	350 cd/m ² (typ.)
Contrast Ratio	900 : 1
View Angle (U/D/R/L)	89°/89°/89°/89°
Backlight Type	LED
Power Supply	
Adapter Input	100 ~ 240VAC (full range)
Adapter Output	19VDC, 3.42A, 65W
Battery Type	Li-battery pack
Battery Capacity	1 x 2270mAh 4-cell external battery pack
	1 x 2270mAh 2-cell internal battery pack (optional)
Battery Life	Up to 8 hours (depends on configuration and use)
Mechanical & Environmental	
Operating Temp.	-20 ~ 45°C (-4 ~ 113°F)
Storage Temp.	-20 ~ 60°C (-4 ~ 140°F)
Charging Temp.	0 ~ 35°C (32 ~ 95°F)
Operating Humidity	10 ~ 95% @ 45°C (non-condensing)
Dimensions (W x H x D)	260 x 200 x 30.6 mm (10.24" x 7.87" x 1.20")
Gross Weight	1.0 kg (2.20 lb) w/o 2-cell internal battery pack
Vibration	20 to 1000 Hz @ 1 grms per MIL-STD 810G (operating)
	20 to 1000 Hz @ 3 grms per MIL-STD 810G (non-operating)
Shock	11 ms @ 20G per MIL-STD 810G for unit only (operating)
	11 ms @ 40G per MIL-STD 810G for unit only (non-operating)
Transit Drop	1.2m (4ft.) per MIL-STD-810G for whole unit
IP Rating	IP65
Regulatory	CE EN55022 class B
	FCC 47 CFR, Part 15 Subpart B
OS Support	
Windows Embedded 7 / Windows 7 Professional	
Windows Embedded Standard 8.0 / Windows Embedded 8.1 Industry Pro	
Windows 10 IoT Entry 2016 LTSB	
Linux: Ubuntu	

1.3.2 G0975M

System		
CPU	Intel® Celeron® Processor N2930 quad-core 1.83 GHz	
Graphics Controller	Intel® HD Graphics	
Memory	2GB DDR3L SO-DIMM memory module installed (optional up to 8GB)	
BIOS	UEFI BIOS	
Audio	1 x integrated microphone	
	2 x piezoelectric speaker	
	1 x 3.5 mm headset combo jack	
Storage	1 x 32GB MLC mSATA SSD	
Peripherals and Devices		
Camera	1 x 5.0 MP rear AF CMOS camera with LED (optional)	
WLAN & Bluetooth	1 x WLAN 802.11 a/b/g/n & Bluetooth 4.0 LE, class 2	
Sensor	Accelerometer, Magnetometer, Light Sensor	
I/O Interface		
USB Port	1 x USB 3.0 Type-A port	
	1 x USB 2.0 Micro Type-B port	
SD Card	1 x microSD/SDHC/SDXC slot	
HDMI	1 x Mini HDMI 1.4 port	
Docking Port	1 x 8-pin docking connector	
Reset	1 x reset button	
Button & Indicator		
Function Key	1 x Power key; 10 x Numeric keys (0 ~ 9); 1 x Enter key; 4-way navigation key; 4 x Function keys;	1 x ESC key; 1 x Backspace; 1 x Dot (.) key; 1 x Brightness key;
	LED Indicators	1 x Power/Battery LED 1 x WLAN LED 1 x Bluetooth LED

Touch Screen	
Type	10-point Projected Capacitive Touch w/ Corning® Gorilla® Glass
Light Transparency	84.5% (typ.)
Controller Interface	USB interface
LCD Display	
Size/Type	9.7" XGA IPS LED display
Max. Resolution	1024x768 (XGA), w/ 262,144 colors
Luminance	350 cd/m ² (typ.)
Contrast Ratio	900 : 1
View Angle (U/D/ R/L)	89°/89°/89°/89°
Backlight Type	LED
Power Supply	
Adapter Input	100 ~ 240VAC (full range)
Adapter Output	19VDC, 3.42A, 65W
Battery Type	Li-battery pack
Battery Capacity	1 x 2270mAh 4-cell external battery pack
Battery Life	Up to 4 hours (depends on configuration and use)
Mechanical & Environmental	
Operating Temp.	-20 ~ 45°C (-4 ~ 113°F)
Storage Temp.	-20 ~ 60°C (-4 ~ 140°F)
Charging Temp.	0 ~ 35°C (32 ~ 95°F)
Operating Humidity	10 ~ 95% @ 45°C (non-condensing)
Dimensions (WxHxD)	260 x 200 x 30.6 mm (10.24" x 7.87" x 1.20")
Gross Weight	0.9 kg (1.98 lb) w/ 3-cell external battery pack
Vibration	20 to 1000 Hz @ 1 grms per MIL-STD 810G (operating)
	20 to 1000 Hz @ 3 grms per MIL-STD 810G (non-operating)
Shock	11 ms @ 20G per MIL-STD 810G for unit only (operating)
	11 ms @ 40G per MIL-STD 810G for unit only (non-operating)
Transit Drop	1.2m (4ft.) per MIL-STD-810G for whole unit

IP Rating	IP65
Regulatory	CE EN55022 class B FCC 47 CFR, Part 15 Subpart B
OS Support	
Windows Embedded 7 / Windows 7 Professional Windows Embedded Standard 8.0 / Windows Embedded 8.1 Industry Pro Windows 10 IoT Entry 2016 LTSC Linux: Ubuntu	

1.4 Dimensions

1.4.1 G0975

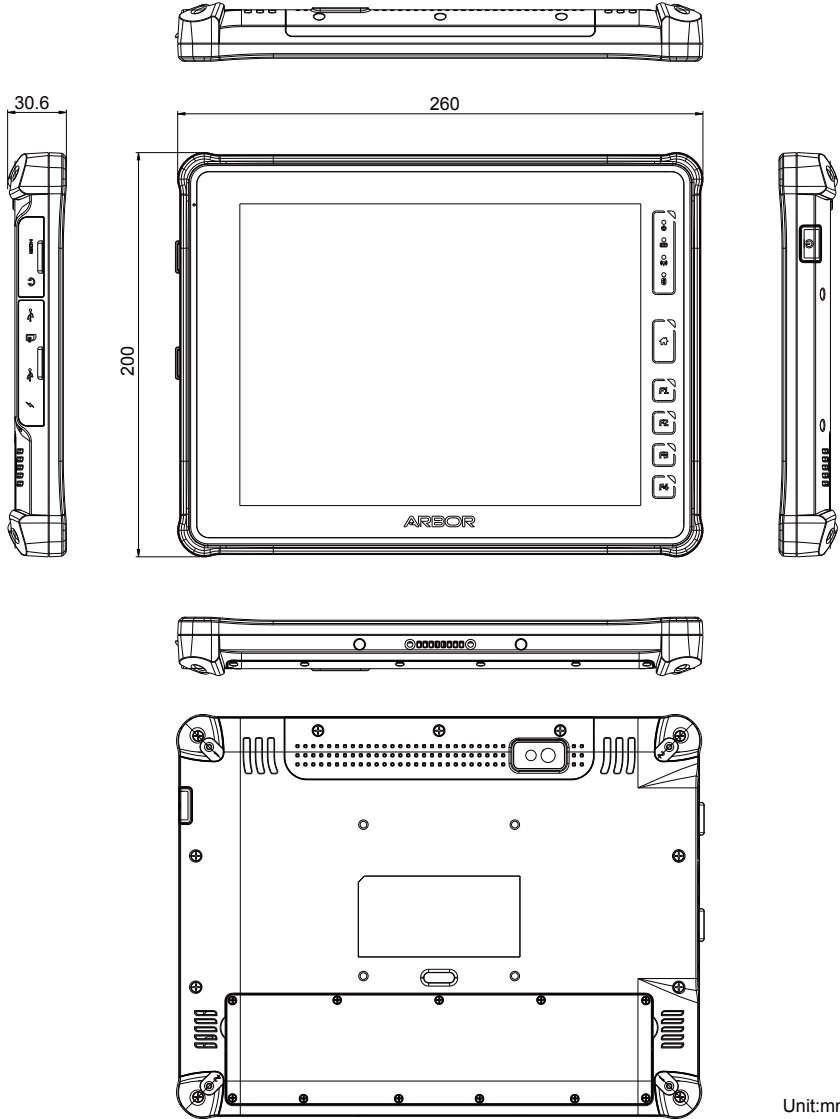

Unit:mm

1.4.2 G0975M

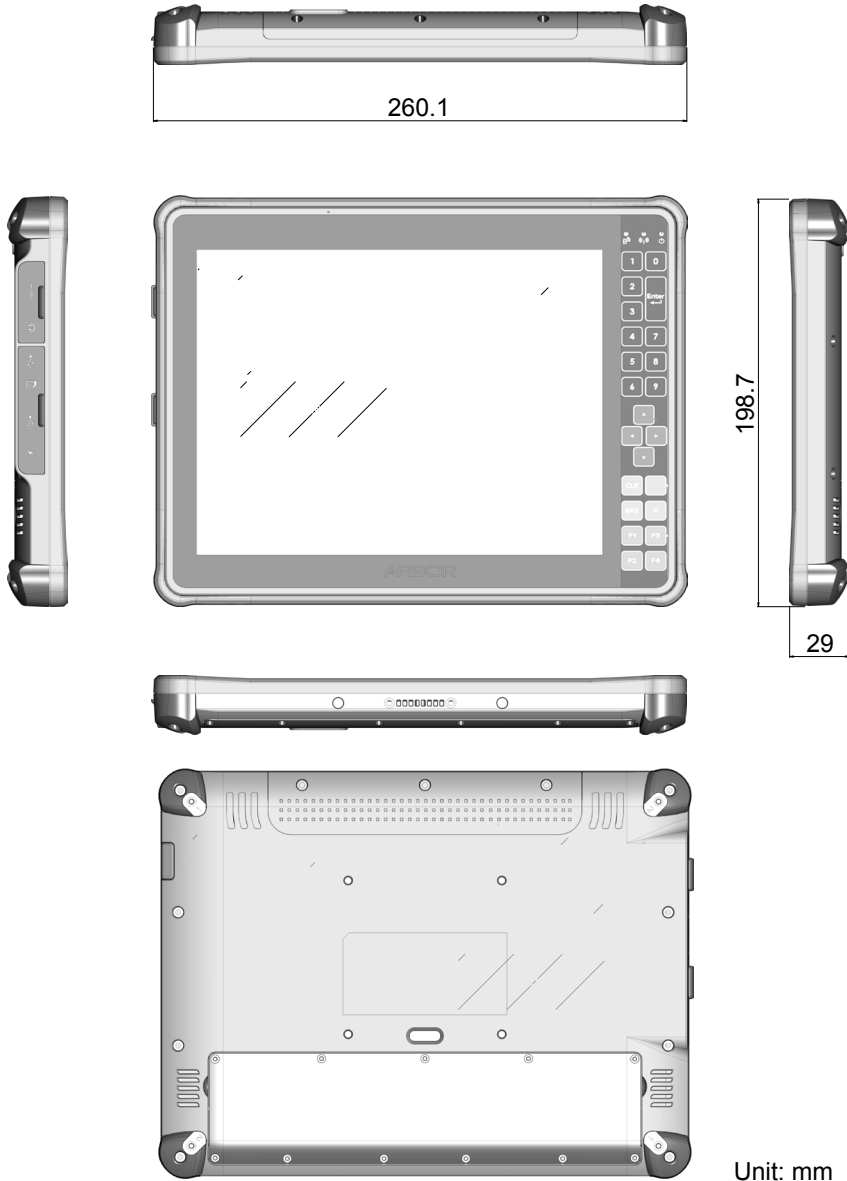

This page is intentionally left blank.

Chapter 2

Getting Started

2.1 Getting to Know the Computer

2.1.1 Front Side

G0975

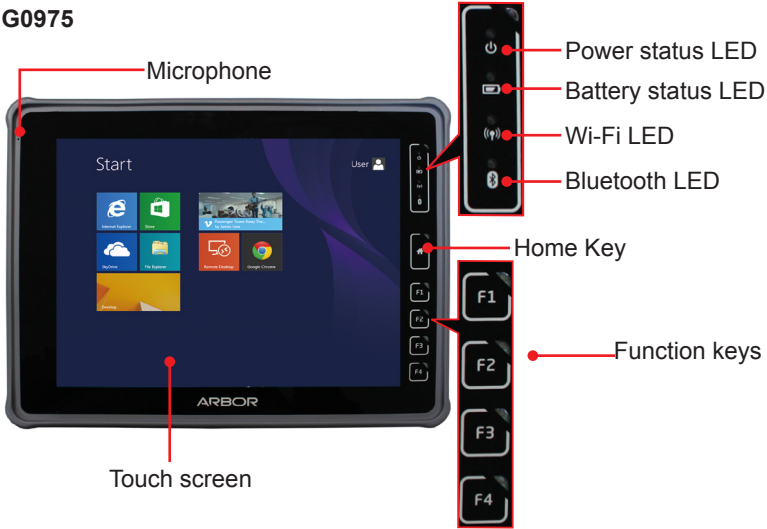

G0975M

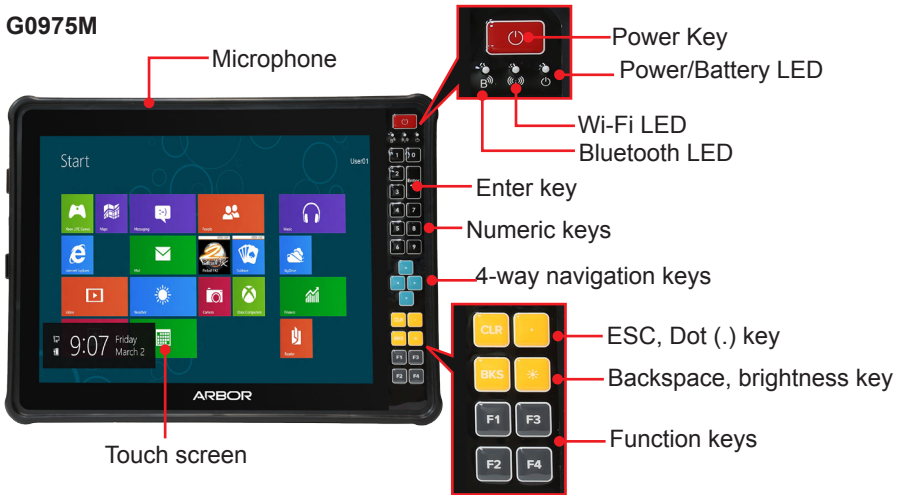

- Microphone





The built-in microphone captures sound and voice when used with a program capable of recording audio.

- Touch Screen

The computer comes with a 10-point projected capacitive touch screen allowing users to interact with the computer without a mouse or keyboard. See [3.1 Using Touch Screen](#) on page [32](#) to know how to perform the touch control and text input on a touch screen.





- Status LED

G0975

Icon	LED	Color	Status	Descriptions
	Power	Green	On	The computer is in main power mode.
			Blinking	The computer is in sleep mode.
			Off	No power is present.
	Battery	Green	On	The battery is not charged. Current battery level: 50% ~ 100%.
			Blinking	Battery charge is in process. *Current battery level: 50% ~ 99%
		Orange	On	The battery is not charged *Current battery level: 16% ~ 49%.
			Blinking	Battery charge is in process. Current battery level: 16% ~ 49%.
		Red	On	The battery is not charged. *Current battery level: 0% ~ 15%.
			Blinking	Battery charge is in process. *Current battery level: 0% ~ 15%.
		N/A	Off	No battery is present.
			Wi-Fi	Green
Off	The Wi-Fi is disabled.			
	Bluetooth	Blue	On	The Bluetooth is enabled.
			Off	The Bluetooth is disabled.

* The battery level is an average between the batteries present to the computer.

G0975M

Icon	LED	Color	Status	Descriptions
	Power/ Battery	Green	On	The computer is in main power mode.
			Blinking	The computer is in sleep mode.
			Off	No power is present.
		Red	Blinking	
	Battery	Green	On	The battery is not charged. Current battery level: 50% ~ 100%.
			Blinking	Battery charge is in process. *Current battery level:50% ~ 99%
		Orange	On	The battery is not charged *Current battery level: 16% ~ 49%.
			Blinking	Battery charge is in process. Current battery level: 16% ~ 49%.
		Red	On	The battery is not charged. *Current battery level: 0% ~ 15%.
			Blinking	Battery charge is in process. *Current battery level: 0% ~ 15%.
		N/A	Off	No battery is present.
	Wi-Fi	Green	On	The Wi-Fi is enabled.
			Off	The Wi-Fi is disabled.
	Bluetooth	Blue	On	The Bluetooth is enabled.
			Off	The Bluetooth is disabled.

* The battery level is an average between the batteries present to the computer.

- Power key (G0975M only)

Use the power key to power on/off the computer, or to put the computer to Sleep or Hibernation mode. The function is the same as the power key on the side of the G0975. See [2.1.2 Left and Right Sides](#) for details.

- Enter key, numeric keys, navigation keys, ESC, Dot, Backspace, brightness keys (G0975M only)

These key are fairly self-explanatory. You can use these keys to speed up data input.

- Function Keys

Four functions keys are available enabling you to quickly execute certain programs or functions. If you didn't install the **ARBOR System Suite**, then the functions of these keys are defined by Windows system. For example, F1 is used to launch Help and F2 is to rename a selected file or folder.

Once you installed the **ARBOR System Suite**, the keys will be associated with most commonly used features such as Wi-Fi or Bluetooth. The default function of each key is as below:

- **F1:** To enable/disable the Wi-Fi function.
- **F2:** To enable/disable the Bluetooth function.
- **F3:** To launch/close the camera utility (for G0975 only).
- **F4:** To launch/close ARBOR System Suite.

For more information, see [3.2 Function Keys](#) on page [34](#).

- Home Key (G0975 only)

Press to go back to Windows home screen.

2.1.2 Left and Right Sides

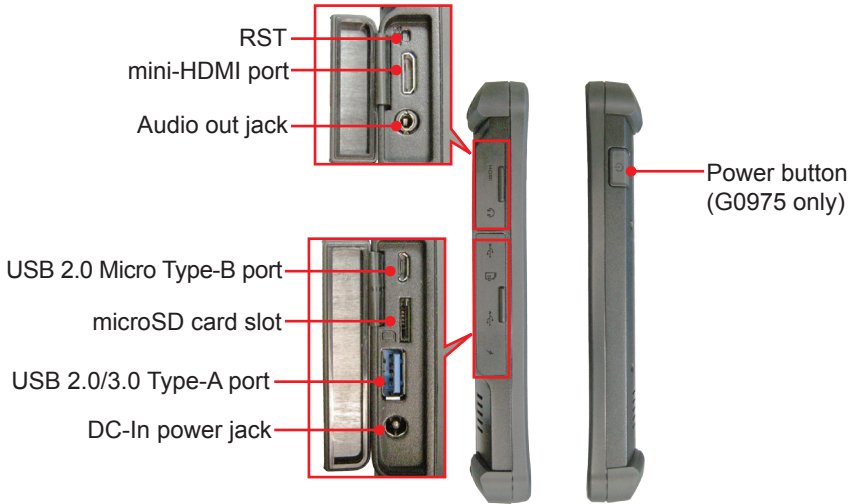



- I/O Ports and Controls

Items	Descriptions
RST	Reset button. Use the reset button if your computer can't be shut down normally. Insert a paper clip to the button and the computer will be shut down. This method is considered only if you have tried pressing Ctrl+Alt+Delete or holding down the power button for four to five seconds but still cannot reboot the computer.
mini-HDMI port	To connect to a high-definition monitor.
Audio out	3.5mm combo audio/microphone jack. To connect to a set of headphones or speakers.
USB 2.0 Micro Type-B port	To connect to a USB device.

Items	Descriptions
microSD card slot	To insert a microSDXC/SDHC/SD card. When inserting the card, make sure to position the card as the graphic indicates, and fully insert the card into the slot until it cannot be inserted any more.
USB 3.0/2.0 Type-A port	To connect to a USB device. For Windows 7, make sure to install USB 3.0 driver on the provided CD.
DC-In power jack	To connect to the power adapter to provide power to the computer or to charge the battery.

- Power Button (for G0975 only)

Use the **Power Button** to power on/off the computer, or to put the computer to **Sleep** or **Hibernation** mode. Refer to the following table for control options.

Control	Operations
To power on the computer	Press-and-hold the Power Button until the power LED  lights green.
To put the computer into the sleep state	Press (without holding) the Power Button .
To wake the computer from the sleep state	Press (without holding) the Power Button .
To resume the computer from hibernation state	Press-and-hold the Power Button until the power LED  lights green.

2.1.3 Bottom Side



- Docking Connector
8-pin connector for connection with desktop or vehicle-mount cradle.

2.1.4 Rear Side

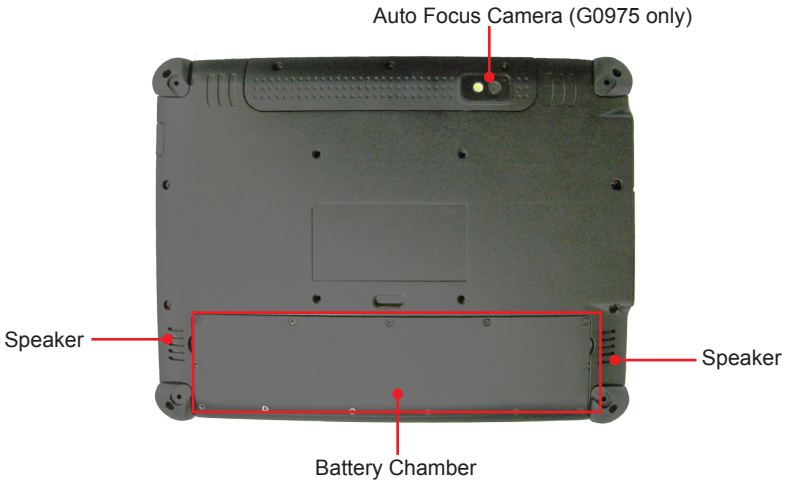

- Auto Focus Camera (for G0975 only)
A 5.0 MP CMOS auto-focus camera with LED flash. For more information, see [3.5. Using the Camera \(for G0975 Only\)](#) on page [42](#).
- Speaker
Piezoelectric speakers for audio output.
- Battery Chamber
External battery pack chamber. To replace or install the battery pack, see [2.3 Installing/Replacing the External Battery Pack](#) on page [21](#).

2.2 Installing Memory Card

The computer has a microSD card slot. You can insert a microSD card to provide additional storage space or use it for file transfer.

To install a microSD card to your computer:

1. On the left side of the computer, open the upper rubber cover and locate the microSD card slot.
2. Position the card as the graphic indicates.
3. Fully insert the card into the slot until it clicks into place.
4. Close the microSD card slot cover.

2.3 Installing/Replacing the External Battery Pack

The computer comes with an internal and an external battery pack. The internal battery pack is a configure-to-order service and is not allowed for installing or replacing by yourself. Do NOT disassemble the internal battery pack or your warranty will be void. But you can install or replace the external battery pack if needed. To do so, follow the steps below:

1. Turn off the computer and disconnect the computer from the external power.
2. Remove any peripheral devices connected to the computer.
3. Place the computer face-down on a flat surface.
4. Find the battery chamber on the rear of the computer. Loosen and remove the screws securing the battery chamber cover.

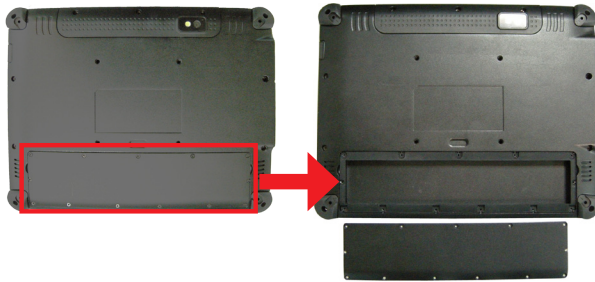

5. The inside of the battery chamber comes to view.

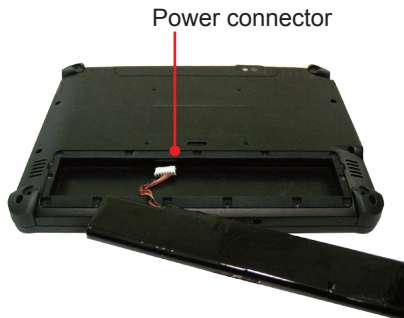

6. Find the power connector for the external battery inside the battery chamber as illustrated above.

To remove an existing external battery, disconnect the battery's power cable first and then remove the battery.

To install a new external battery, plug the battery's power cable to the power connector first.



7. Fit the battery into the chamber and restore the chamber cover.
8. Secure the cover with the screws you removed in Step 4.

2.4 Charging the Battery Pack

To recharge the battery inside the computer:

1. Connect the power adapter to the computer's power jack and a power source. You can find power adapter & cord in the accessory box.
2. The battery LED indicator () blinks to indicate that charging is in progress. The battery LED color changes according the battery level as described in the Status LED section in [2.1.1 Front Side](#) on page [14](#). When the battery is fully charged, the battery LED indicator lights solid green.

Important Notice on Charging the Battery

When charging the battery, note that:

- The charging temperature for the computer is 0~35°C (32~95°F). However, it's recommended to charge the battery at a temperature around 25°C (77°F).
- In case you need to charge the battery at a temperature of **35°C (95°F)**, make sure you **adjust the LCD brightness to the lowest level** to ensure the charging process.
- The battery will be fully charged within 3-4 hours (depending on the capacity of the battery). When charging finishes, it's recommended to remove the adapter from the computer.
- It's recommended not to recharge intermittently, which means not to plug and unplug the power adapter frequently in a short period of time.
- Do not use the power adapter that is not made for your computer. Supplying the computer with inappropriate voltage may cause harm to the battery or, even worse, burn the computer.
- The lithium-ion battery is currently one of the most popular battery pack. The best advantage is that it has no memory effect, so users needn't worry about that issue. Users can charge the battery anytime whether it is fully drained or not. However, it's recommended that you drain the battery until the system shows power shortage warning and then recharge the battery. Doing so is helpful to the reliability of your battery.
- Don't use the battery pack as a power supply for other equipment.

2.5 Driver Installation

The computer comes with a CD that contains device drivers as well as some programs and utilities. You need to install the drivers to activate the devices and some device-related services. Some drivers will come with driver-related programs to facilitate the application. To install the drivers and utilities, make sure to follow the instructions (e.g., the installation sequence) given in this section to proceed.

In addition, the CD includes a number of optional utilities. You may install those utilities as needed.

See the table below for the CD-DOM content and the driver needed to be installed for the computer:

Driver Type	Necessity	Descriptions
Chipset	Required	Install the chipset-related drivers to the computer: <ul style="list-style-type: none"> • Chipset: Install the chipset driver. Make sure to install the chipset driver before installing other device drivers to prevent errors. • TXE: Install the Intel Trusted Execution Engine and Trusted Connect Service to enable Intel Trusted Execution Engine Interface. • Audio: Install the audio driver and application. • Graphic 64/32bit: Install the graphics driver. Select 64 or 32-bit according to your operating system. • DPTF: Install the Intel Dynamic Platform and Thermal Framework component.
Wi-Fi	Required	Install the Wi-Fi driver and application.
Bluetooth	Required	Install the Bluetooth driver and application.
3G, 4G	Required	Install the 3G/4G driver.
Function Keys	Recommended	Install the ARBOR System Suite to associate a function key with a specific feature or application program.
Power Saving AP	Recommended	Install the power saving application.
WINUSB	Required for Win7	For Windows 7, install the USB driver to use the USB 3.0 interface.

Driver Type	Necessity	Descriptions
Tools	Required	Install Microsoft .NET Framework 4.0

To install the drivers:

1. Connect a USB CD-ROM drive (not provided) to the computer. According to your CD-ROM drive, you may need to connect it to a power supply.
2. Insert the provided CD to the CD-ROM drive. In a few seconds, a dialog box opens asking what to do with the disc. Tap **Run AUTORUN.EXE** to auto-run the driver CD.

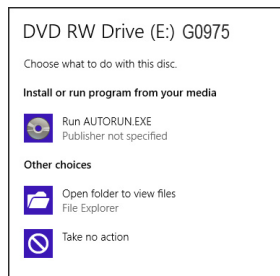

3. Tap **Windows 7** or **Windows 8** according to your operating system.

If you want to install the drivers for the optional vehicle/desktop cradle, please install the drivers for the G0975 first. Then refer to [A. Using the Vehicle Cradle \(Optional\)](#) on page 62 to install the cradle and the drivers.



- The drivers menu then opens. Tap **Chipset** to install the chipset-related drivers first.



- Tap **Chipset** to install the chipset driver. Then install other drivers, including **TXE, Audio, Graphic** and **DPTF**.

Just follow the on-screen instructions to proceed. After installing the drivers on this page, tap **Go Back**.

Caution: Make sure to install the chipset driver first before installing other device drivers or otherwise errors may occur.

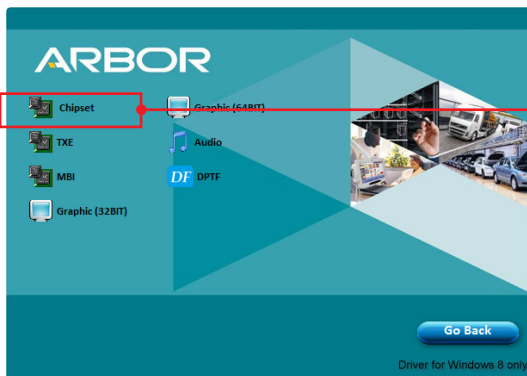

Make sure to install the chipset driver first.

- Continue to install the remaining drivers, including **WiFi**, **Bluetooth** and **3G/4G**. Then install the utilities like **Function Keys** and **Power Saving AP**.



- The installation process of each driver is basically the same. Just follow the on-screen instructions to proceed.

Notice on USB Hub Driver

The G0975 comes with a USB hub controller for the two USB ports. Just in case you need to install the USB hub controller driver, follow the steps below:

- Tap **Start > Control Panel > Hardware and Sound > Device Manager**.
- Expand **Other devices** and locate the **Bridge Device** item.

Right-click the **Bridge Device** item and select **Update Driver Software**.

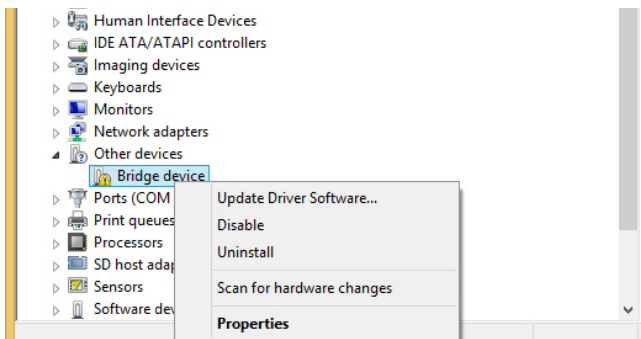

3. Select **Browse my computer for driver software**.

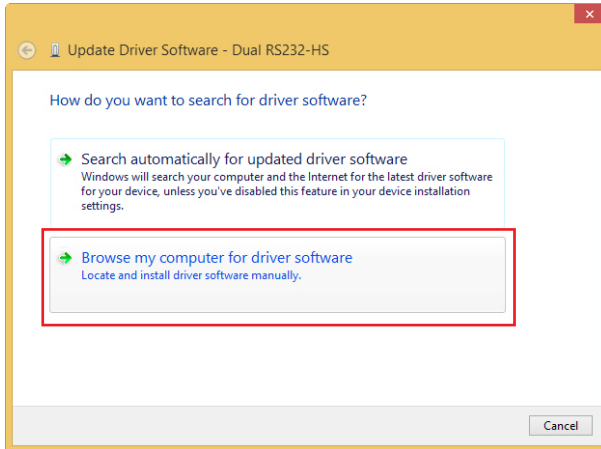

4. Tap **Browse** to locate the driver under the following path:

disk drive:\Driver\Your Operating System\WINUSB Driver

Check the **Include subfolders** checkbox and then tap **Next**.

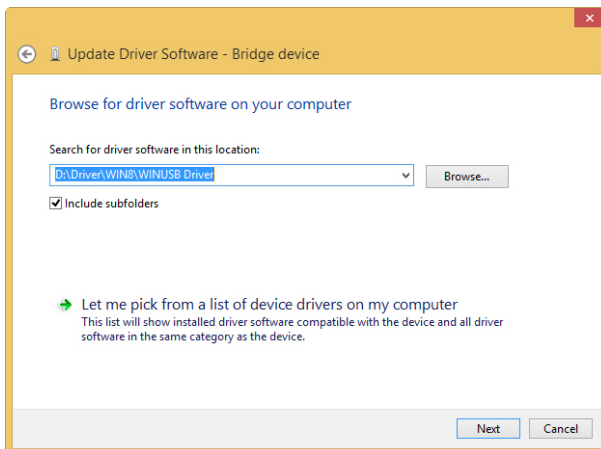

5. When asked if you want to install the software, tap **Install**.

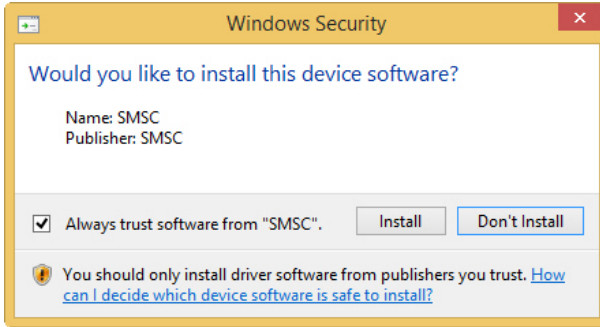

6. When the driver installation is finished, tap **Close**.

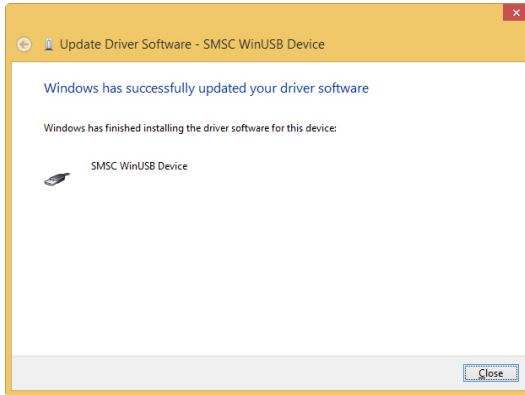

7. When the installation is complete, you should be able to see an **SMSC WinUSB Device** item under the **SMSC WinUSB** group in the **Device Manager**.

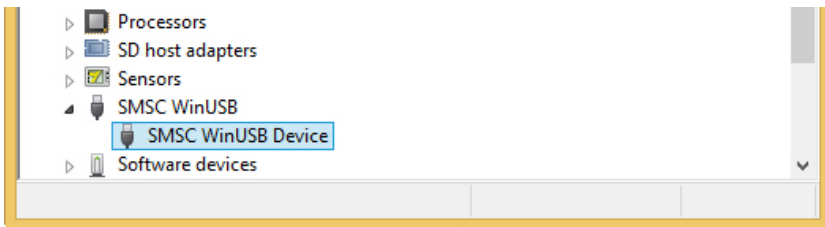

Chapter 3

Using the Computer

3.1 Using Touch Screen

The computer comes with a projected capacitive touch screen. Touch control is the main way and an intuitive way to interact with the computer. Users are able to manipulate icons, graphic buttons, menus, property sheets, the on-screen keyboard or any on-screen items with touch control. This chapter will walk you through the basic operations for touch control.

3.1.1 Projected Capacitive Touch

Unlike the resistive touch, the projected capacitive touch works by the change of capacitance when a conductive object, such as a finger, contact the touch screen. Hence it requires only a human finger and zero force to trigger actions from the projected capacitive touch screen. And no calibration is needed.

If the computer runs Windows 7/8, the projected capacitive touch screen is ready to function when the computer is delivered. No driver is needed.

3.1.2 Text Input

The computer doesn't have a physical keyboard to receive user's text input. To input text on the computer, it relies on either an external USB keyboard, or the "on-screen keyboard", or the Windows-featured handwriting recognition.

3.1.2.1 On-screen Keyboard

An "on-screen keyboard" is a virtual keyboard with all the standard keys. With Windows you can use either a touch keyboard or thumb keyboard to facilitate text input. To open the Windows on-screen keyboard:

1. Tap the keyboard icon on the Windows taskbar.

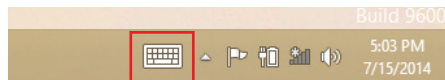

2. The **Input Panel** opens in either keyboard mode or handwriting mode, according to your previous use. Tap the icon in the lower right corner to switch between the modes.

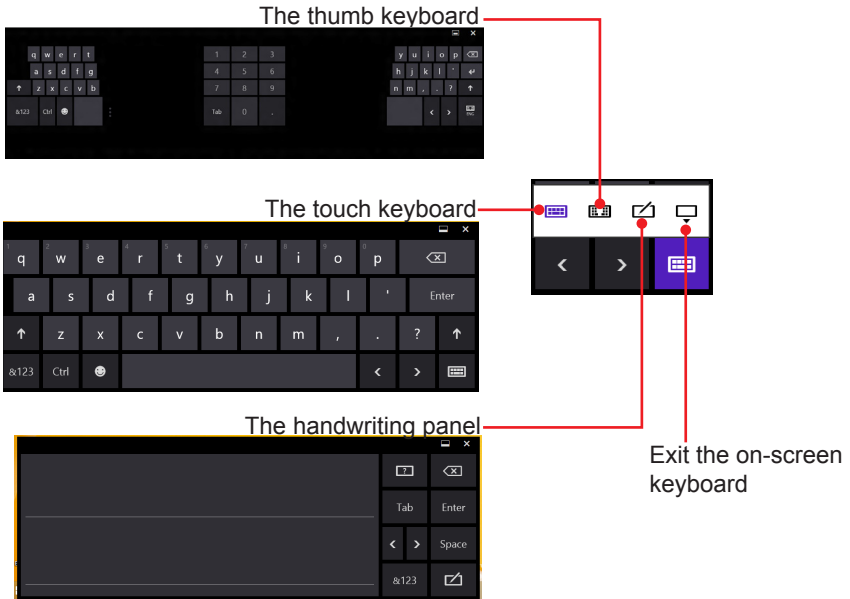

3. To use the touch or thumb keyboard, just enter text by tapping the keys.

3.1.2.2 Handwriting Recognition

“Handwriting Recognition” is an input method that interprets and converts handwriting to text. The Windows features a “writing pad” to get the job done.

To launch the Windows handwriting panel:

1. Tap the keyboard icon on the Windows taskbar to open the **Input Panel** as described in [3.1.2.2 Handwriting Recognition](#) on page 33.

If it's in keyboard mode, tap the icon in the lower right corner and tap the handwriting icon to switch to handwriting mode.

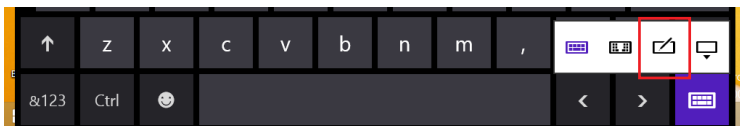

2. Write in the writing area. Then tap the bottom-right **Enter** button to enter the text in a text field.

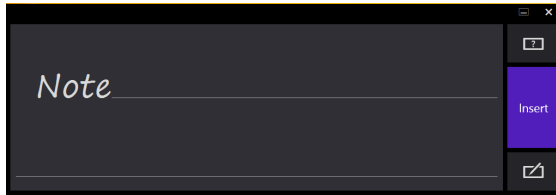

3.2 Function Keys

3.2.1 Using the Function Keys

The computer comes with four function keys enabling you to quickly execute certain programs or functions. If you didn't install the **ARBOR System Suite**, a function key association program available in the provided CD (see [2.5 Driver Installation](#) on page 25), then the functions of these keys are defined by Windows system. For example, F1 is used to launch Help and F2 is to rename a selected file or folder.

Once you installed the **ARBOR System Suite**, by default the keys will be associated with most commonly used features such as Wi-Fi or Bluetooth as below:

- **F1:** To enable/disable Wi-Fi function.
- **F2:** To enable/disable Bluetooth function.
- **F3:** To launch/close the camera utility (for G0975 only).
- **F4:** To launch/close ARBOR System Suite.

3.2.2 Customizing the Function Keys

With the **ARBOR System Suite** installed on your computer, you can re-define the function keys according to your requirement. To do so:

1. Tap the **ARBOR System Suite** shortcut  in the notification area.

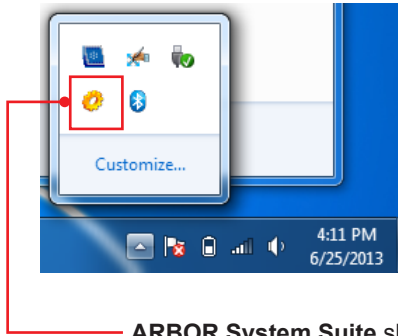

ARBOR System Suite shortcut in the notification area

2. The **ARBOR System Suite** then opens on-screen. For the key that you want to reassign a function, simply tap the intended function. Assigned function will be highlighted in blue.



Function key assignment panel

Status bar

For more information on using the **ARBOR System Suite**, see [4.1 ARBOR System Suite](#) on page [46](#).

3.3 Using the Wi-Fi Feature

The computer is built-in with a Wi-Fi module for Wi-Fi networking. Once the driver is installed as described in [2.5 Driver Installation](#) on page [25](#), a Wi-Fi signal strength icon  shows up in the notification area.

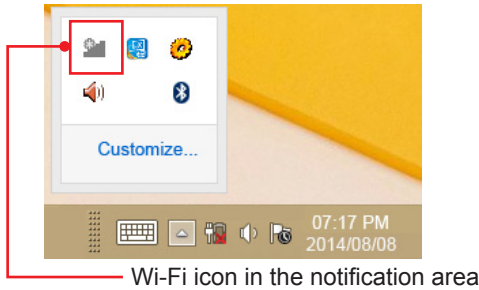



The following descriptions assume that you have installed the **ARBOR System Suite** to use the function key. Follow the guide below to connect the computer to a Wi-Fi hotspot:

1. Launch the Wi-Fi module by hitting the function key (F1 by default). The system shows the Wi-Fi status in the bottom right corner of the screen.

Hitting the function key will toggle on/off the Wi-Fi function. When Wi-Fi is enabled, the function icon is highlighted in blue or otherwise dimmed.



When Wi-Fi is enabled, the Wi-Fi signal strength icon in Windows notification area also changes from  to .



Note: If you didn't install the **ARBOR System Suite** and want to launch the Wi-Fi function, please refer to Windows online help on how to turn on Wi-Fi.

2. Tap the Wi-Fi signal strength icon in the notification area.
3. A list opens and shows the Wi-Fi hotspots available within the wireless coverage of the computer.

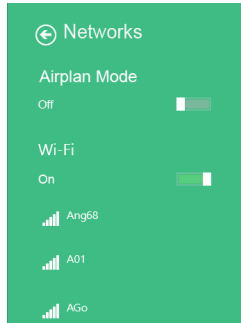

4. Tap the desired network to connect it.

If the network to connect is a secured network, a dialog will open and request for the password. Enter the password to access the Wi-Fi network. If it is an open network, it will be connected in a few seconds.

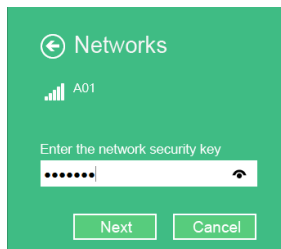

5. When the computer is connected to a Wi-Fi network, "Connected" will be displayed and the Wi-Fi signal strength icon in the notification area changes to .

Note: To conserve power, always turn off the Wi-Fi module when it isn't used.

3.4 Using the Bluetooth Feature

Bluetooth enables the wireless connection over a short distance about 8 meters. It is specified as a “wireless personal area network” (WPAN). The computer is Bluetooth-enabled to synchronize data with other Bluetooth-capable devices such as PCs, laptops, hands-free, headsets, printers, PDAs and cell phones.

Once the Bluetooth driver is installed as described in [2.5 Driver Installation](#) on page [25](#), you can start to use the Bluetooth function.

The following descriptions assume that you have installed the **ARBOR System Suite** to use the function key. Follow the guide below to proceed.

3.4.1 Launching the Bluetooth Feature

To be able to use Bluetooth, launch the Bluetooth module first:

1. Launch the Bluetooth module by hitting the function key (F2 by default). The system shows the Bluetooth status in the bottom right corner of the screen.

Hitting the function key will toggle on/off the Bluetooth function. When Bluetooth is enabled, the function icon is highlighted in blue or otherwise dimmed.



Bluetooth
enabled



Bluetooth
disabled

When Bluetooth is enabled, a Bluetooth icon  shows up in the notification area, meaning the Bluetooth module is activated.

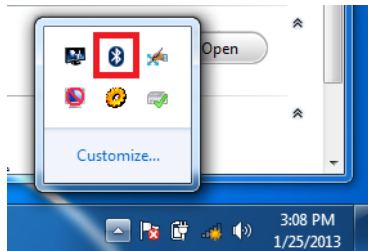

Note: To conserve power, always power off the Bluetooth module when it isn't used.

3.4.2 Pairing/Connecting with Other Bluetooth Devices

Before the computer can connect with other Bluetooth devices, it has to pair with them. To pair/connect with other Bluetooth devices:

1. Launch the Bluetooth module as described in [3.4.1 Launching the Bluetooth Feature](#) on page 38.
2. From the notification area, tap the Bluetooth icon .

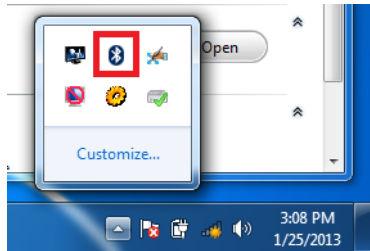

3. A context menu opens. Select **Add a Device** from the context menu that opens.

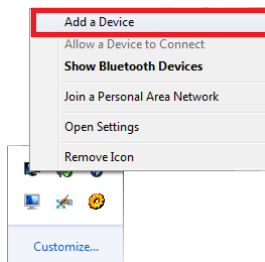

4. An **Add a device** window opens. Select the Bluetooth device to connect and follow the on-screen instructions to proceed.

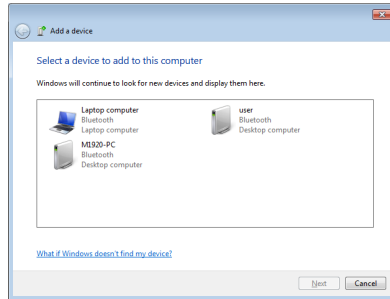

3.4.3 Bluetooth Device Name

By default, the computer's Bluetooth device name is the computer name that is viewable at **Control Panel | System and Security | System**.

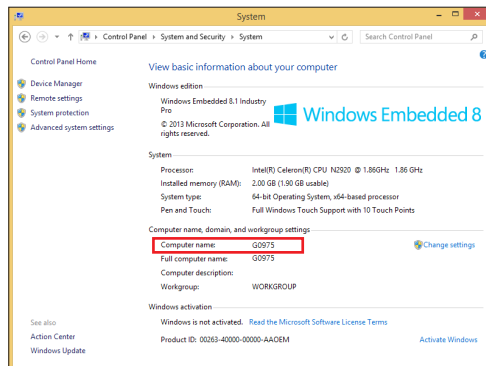

3.4.4 Hiding/Exposing the Computer

By default, the computer is NOT discoverable by other Bluetooth devices. To hide or expose the computer:

1. Launch the Bluetooth module as described in [3.4.1 Launching the Bluetooth Feature](#) on page [38](#).
2. From the notification area, tap the Bluetooth icon .

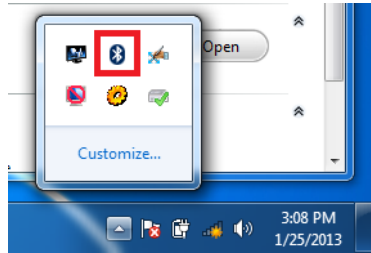

3. A context menu opens. Select **Open Settings** from the context menu.

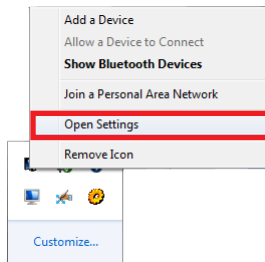

4. The **Bluetooth Settings** dialog box then opens. Tap the **Options** tab and find the **Discovery** section.

To make your computer discoverable to Bluetooth enabled devices, select the check box of **Allow Bluetooth devices to find this computer** or otherwise deselect the check box to make it undiscoverable.

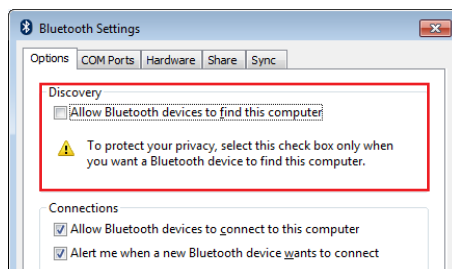

3.5. Using the Camera (for G0975 Only)

The computer comes with a ready-to-use camera without the need to install additional drivers. You can use the camera to take pictures or videos.

3.5.1 Launching the Camera

To launch the camera:

1. Assign a function key to launch the camera module.
2. Launch the camera module by hitting the function key. The system shows the camera status in the bottom right corner of the screen.

Hitting the function key will toggle on/off the camera function. When camera is launched, the function icon is highlighted in blue or otherwise dimmed.



Camera enabled



Camera disabled

After you launch the camera module, a camera program will automatically open in a few seconds.

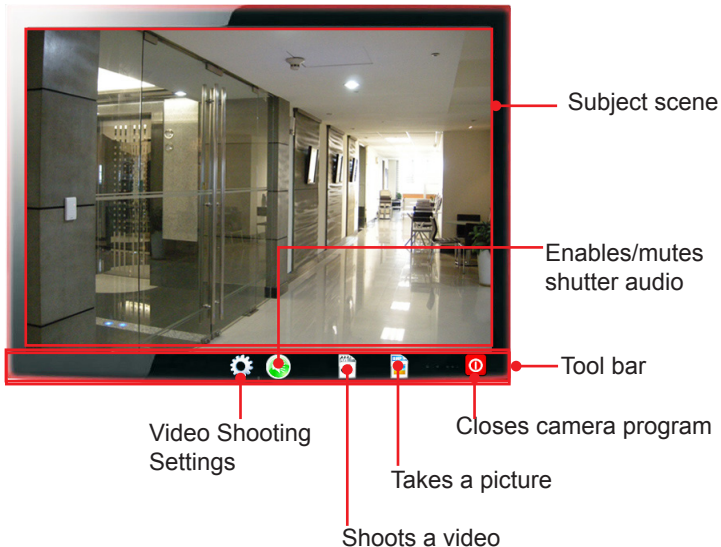

3.5.2 Taking a Picture

To take a picture:

1. Launch the camera as described in [3.5.1 Launching the Camera](#) on page [42](#).

The camera program automatically launches.

2. From the camera application program's tool bar, tap the take-a-picture icon .

The camera then proceeds to take a picture and save it to **local disk** (by default at **C:**) | **Users** | **(your username)** | **My Documents** | **ccd.**)



3.5.3 Shooting a Video

To shoot a video:

1. Launch the camera (also the camcorder) as described in [3.5.1 Launching the Camera](#) on page [42](#).

The camera program automatically launches.

2. From the camera application program's tool bar, tap the shoot-a-video icon .

The  icon then changes to an in-shoot button , and video shooting starts.

3. Tap the in-shoot button  again to stop shooting.

The video shot is saved to **local disk** (by default at **C:**) | **Users** | **(your username)** | **My Documents** | **ccd.**)

3.5.4 Configuring Video Shooting

To configure the video shooting:

1. Launch the camera (also the camcorder) as described in [3.5.1 Launching the Camera](#) on page [42](#).

The camera program automatically launches.

2. From the camera program's tool bar, tap the configuration icon .

The **Properties** dialog box opens.

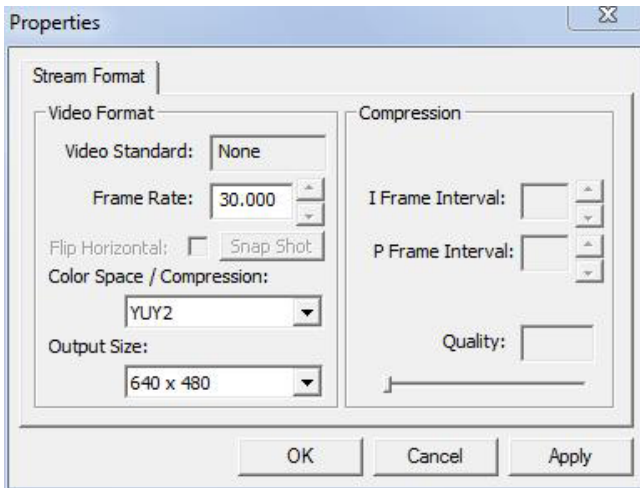

3. Make the configuration as needed.
4. Tap the **Apply** button to apply the changes. Tap the **OK** button to save the changes and exit the dialog box. Or tap the **Cancel** button to quit the changes and exit the dialog box.

Chapter 4

Utilities

4.1 ARBOR System Suite

The **Arbor System Suite** is a utility to control the computer's physical function keys **F1** through **F4**. With this **ARBOR System Suite**, users can associate a function key to turn on/off one of the computer's features or to launch a specific application program installed on the computer.

4.1.2 Accessing ARBOR System Suite

With the **Arbor System Suite** installed on your computer, tap the **Arbor System Suite** shortcut  in the notification area to launch and use **Arbor System Suite**.

The **ARBOR System Suite** then opens on-screen.















- **Function key assignment panel**
The icons indicate the features/programs you can assign to a function key. For which feature/program the icon indicates, see next section.
Assigned features/programs are highlighted in blue.
- **Status bar**
Indicates the on/off status of various functions. When a function is on, its icon is highlighted in blue.

4.1.3 Using ARBOR System Suite

To re-assign a function to a function key, simply tap the intended icon for the desired key. The icon turns to be blue to indicate it's assigned. See the table below for the meaning of each icon.

Note: The panel shows all possible functions across various computer models. Not all functions are available in your computer.

Icons	Descriptions
	Associates a function key to turn on/off 3G.
	Associates a function key to turn on/off Wi-Fi.
	Associates a function key to trigger barcode scanning.
	Associates a function key to turn on/off Bluetooth.
	Associates a function key to turn on/off the camera.
	Associates a function key to turn on/off the RFID reader.
	Associates a function key to enable/mute the speakers.
	Associates a function key to turn on/off the GPS module.
	Associates a function key to show/hide battery level and Wi-Fi signal strength.
	Associates a function key to launch the screen brought up by CTRL+ALT+DEL key combination. It open a screen which shows Lock, Switch User, Sign out, Change a password and Task Manager.

Icons	Descriptions
	Associates a function key to open/close Arbor System Suite .
	Associates a function key to open/close on-screen keyboard.
	Associates a function key to open/close a program installed in the system. When tapping the icon, you will be prompted to select a program to associate with. Browse the Windows to select the executable file of the program to associate.

Chapter 5

BIOS

A BIOS (Basic Input/Output System) is a special utility usually stored in the ROM on the motherboard inside a computer. When you turn on the computer, the BIOS is immediately activated. During the startup, it checks and loads necessary information to ensure the computer can proceed with loading the operating system. The BIOS Setup Utility is typically accessed with a special key sequence, such as “Delete” or “Esc” key as soon as the computer is powering up.

Once you have entered the BIOS, you can get some system information and configure some hardware parameters. In most cases, there will be no need to make adjustments to the BIOS. The default settings apply to most applications and provide optimal performance.

Caution: If you need to make any change, be careful when making changes to the BIOS. Incorrect settings can cause system boot failure or malfunction.

NOTE: For system stability and performance, this BIOS utility is constantly improved. The screenshots demonstrated and descriptions hereinafter are for reference only and may not exactly meet what is presented on-screen.

5.1 Accessing the BIOS Setup Utility

To enter and use the BIOS Setup Utility, prepare a USB keyboard first and then:

1. Connect the USB keyboard to the computer first.
2. Power on the computer and press the “**Delete**” or “**Esc**” key immediately after powering on.
3. Then you will enter the BIOS Setup Utility and see the **Main** setup screen.

BIOS Setup Utility is mainly a key-based navigation interface. The bottom of the screen shows the keys for navigation and changing the settings. Refer to the table below for instructions on using the keys.

Keys	Descriptions
F1	Activate “General Help” screen.
← →	Move to select a particular configuration screen from the top menu bar / Move to highlight items on the screen.
↓ ↑	Move to select an item.

Keys	Descriptions
Enter	Select or enter a submenu
Esc	On the Main Menu – Exit the setup and not save changes into CMOS. On the Sub Menu – Exit current page and return to main menu.
+ / F6	Increase a numeric value.
- / F5	Decrease a numeric value.
F9	Load the optimal defaults. All settings will be set to the optimal defaults at startup.
F10	Save the changes that have been made and exit the BIOS Setup Utility.

5.2 Main Setup

When you first enter the BIOS Setup Utility, you will enter the **Main** setup screen. It reports basic system information and also allows you to configure the **System Date** and **System Time** settings.

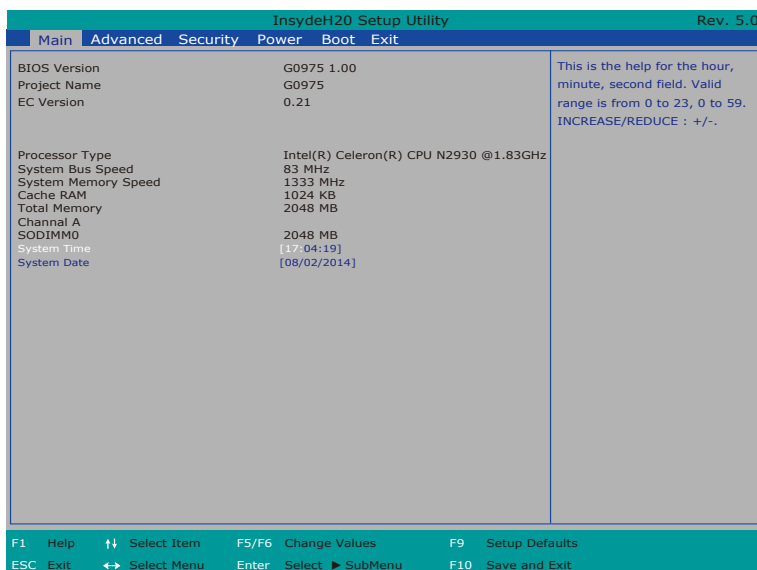

The **Main** setup screen provides the following information and options:

Info / Item	Descriptions
BIOS Version	Displays the computer's BIOS version.
Project Name	Displays the computer's model name.
EC Version	Displays the current version of Embedded Controller.
Processor Type	Displays the computer's processor type.
System Bus Speed	Displays the processor speed.
System Memory Speed	Displays the system memory speed.
Cache RAM	Displays the cache RAM size.
Total Memory	Displays the total RAM.
Channel A	N/A.
SODIMM 0	Displays the RAM of SODIMM 0.
System Time	Sets system time. Valid range is from 0 to 23, 0 to 59 and 0 to 59.
System Date	Sets system date. Valid range is from 1 to 12, 1 to 31 and 2000 to 2099.

5.3 Advanced Settings

The **Advanced** setup screen allows you to change the system and hardware settings. The **Advanced** screen provides the following setting options:

- [5.3.1 Boot Configuration](#) on page [53](#)
- [5.3.2 PCI Express Configuration](#) on page [53](#)
- [5.3.3 Miscellaneous Configuration](#) on page [54](#)
- [5.3.4 Thermal Configuration](#) on page [54](#)
- [5.3.5 SATA Configuration](#) on page [55](#)

Caution: Be careful when making system and hardware changes. Incorrect settings can cause system boot failure or malfunction.

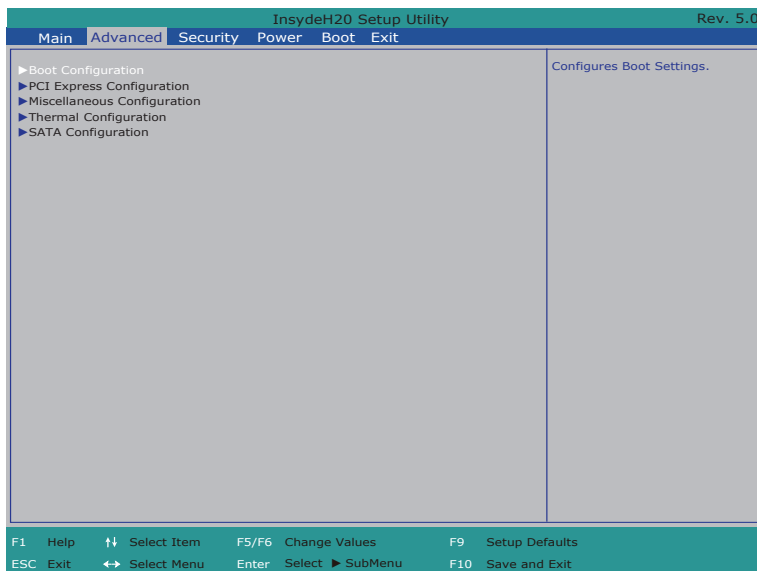

5.3.1 Boot Configuration

The **Boot Configuration** screen provides the following setting options:

Settings	Descriptions
Numlock	Turns on/off the Num Lock key function when the computer is in power-on state.

5.3.2 PCI Express Configuration

The **PCI Express Configuration** screen provides the following setting options:

Settings	Descriptions
PCI Express Root Port 1/2/3/4	<ul style="list-style-type: none"> ▶ PCI Express Root Port: Enables/disables this PCIe port. ▶ PCI Express Port Speed: Select the PCIe port speed. Options are: Auto [default], Gen 1, Gen 2 ▶ PCI Express Port ASPM: Select an ASPM (Active-State Power Management) mode to manage the PCI Express serial link devices in order to reduce power consumption. Options are: Auto [default] : allow BIOS to auto configure Disabled : disable ASPM L0s : force all links to L0s state L1 : force all links to L1 state L0sL1 : force all links to L0s+L1 state

5.3.3 Miscellaneous Configuration

The **Miscellaneous** screen provides the following setting options:

Settings	Description / Available Options
Restore AC Power Loss	Specify what state to go to when power is re-applied after a power failure. Options are: Power on, Power off [default]

5.3.4 Thermal Configuration

The **Thermal Configuration** screen provides the following setting options:

Settings	Descriptions
Thermal Configuration Parameters	<p>Critical Trip Point: Set the value of temperature of the ACPI critical trip point. When this point is reached, the OS will shut down the system.</p> <p>Passive Trip Point: Set the value of temperature of the ACPI passive trip point. When this point is reached, the OS will begin to throttle the processor.</p>

Settings	Descriptions
Dynamic Platform& Thermal Framework	<p>DPTF Feature: Enables/disables the DPTF (Dynamic Platform&Thermal Framework) feature.</p> <p>Note: You must install the DPTF driver as described in 2.5 Driver Installation on page 25 to use this feature.</p>
Thermal Sensor	<p>The following items are available only when DPTF feature is enabled.</p> <p>Thermal Sensor: Enables/disables thermal sensor.</p> <p>If thermal sensor is enabled, below options are available:</p> <p>Critical: Set the value of temperature of the thermal sensor critical trip point. When this point is reached, the OS will shut down the system.</p> <p>Passive: Set the value of temperature of the thermal sensor passive trip point. When this point is reached, the system will throttle the processor.</p>

5.3.5 SATA Configuration

The **SATA Configuration** screen provides the following setting options:

Settings	Descriptions
SATA Controller	<p>Enables/disables the present SATA controller.</p> <p>Options are: Enabled [default], Disabled</p>
Chipset SATA Mode	<p>Configures the mode for the installed drive(s).</p> <p>Options: AHCI [default], IDE</p> <p>IDE Mode: Available only when IDE is selected as Chipset SATA Mode.</p> <p>Options: Native IDE, Legacy IDE</p>
Serial ATA Port 0	<p>Displays the information detected on the installed SATA drive and its security mode.</p>

5.4 Security Settings

The **Security** setup screen allows you to configure BIOS security settings to keep unauthorized people from making any changes to the BIOS.

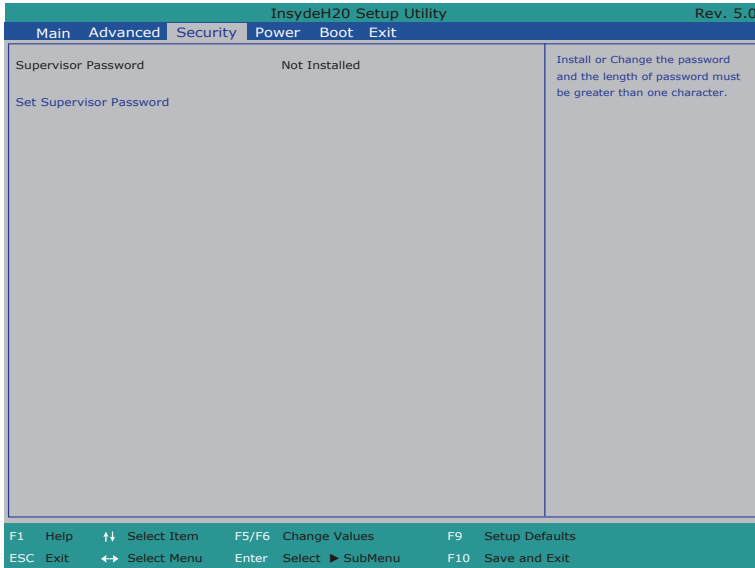

The **Security** screen provides the following setting options:

Settings	Descriptions
Set Supervisor Password	<p>To set up a supervisor password.</p> <p>After selecting Set Supervisor Password, a dialog box then pops up on-screen. Enter and confirm your desired password. The length of the password must be greater than one character.</p> <p>To change an existing supervisor password, you will need to enter the original password.</p>
Power on Password	<p>This item is available only when supervisor password is set.</p> <p>Enables/disables power on password.</p> <p>If enabled, you will be prompted to enter the supervisor password on POST time.</p>

5.5 Power Settings

The **Power** setup screen contains only one item “Advanced CPU Control” which allows you to configure the CPU power mode.

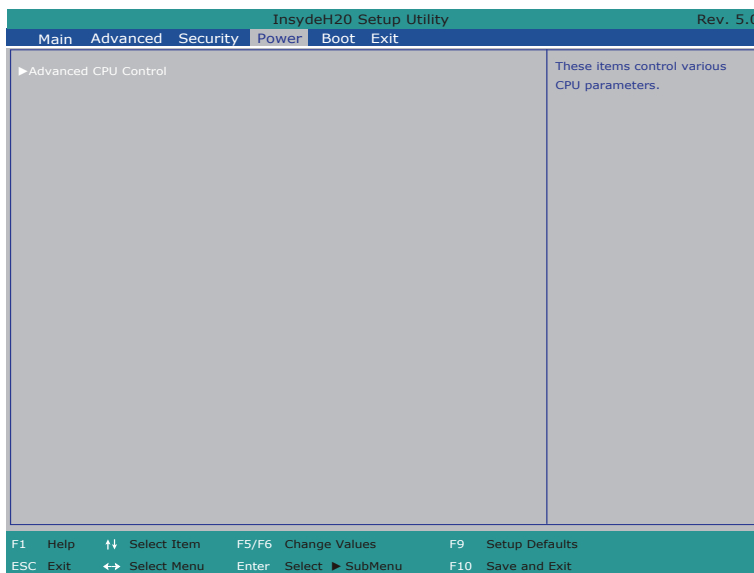

The **Advanced CPU control** screen provides the following setting options:

Settings	Descriptions
C-States	Enables/disables processor idle power saving states (C-states).
Enhanced C-States	Enables/disables P-state transitions to occur in combination with C-states.
Max C-States	Set the Max CPC state. Options: C7 [default], C6, C1

5.6 Boot Settings

The **Boot** menu configures how to boot up the system such as the configuration of boot device priority.

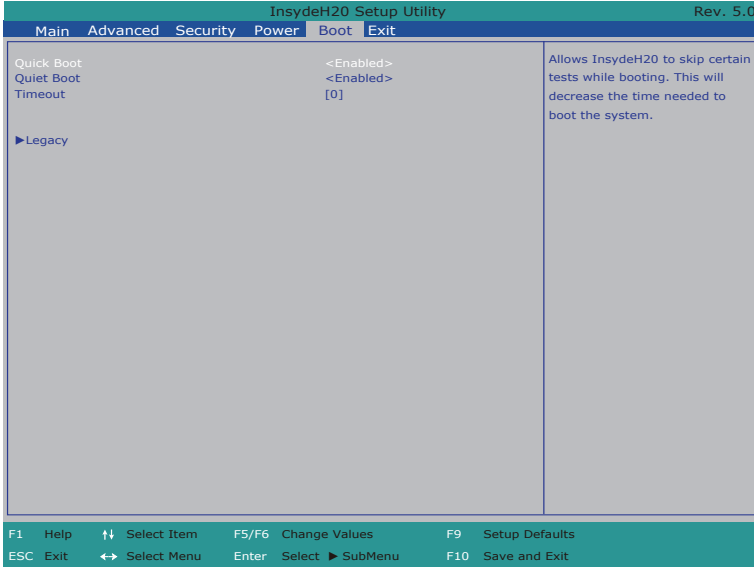

The **Boot** screen provides the following setting options:

Settings	Descriptions
Quick Boot	Allow InsydeH20 to skip certain tests while booting. This will decrease the time need to boot the system.
Quiet Boot	Disables or enables booting in text mode.
Timeout	Set the number of seconds that the firmware will wait before booting the original default boot selection.

Settings	Descriptions
Legacy	<p>Boot Device Priority</p> <p>Normal Boot Menu: Select a boot option priority. Options: Normal [default], Advance When Normal is selected, the following items are available:</p> <p>Boot type order: Change boot type order.</p> <p>Hard Disk Drive: Change hard disk drive. When Advance is selected, the hard disk drive info will be displayed.</p>

5.7 Exit Options

The **Exit** screen provides the options regarding saving changes, quitting the utility and recovering defaults.

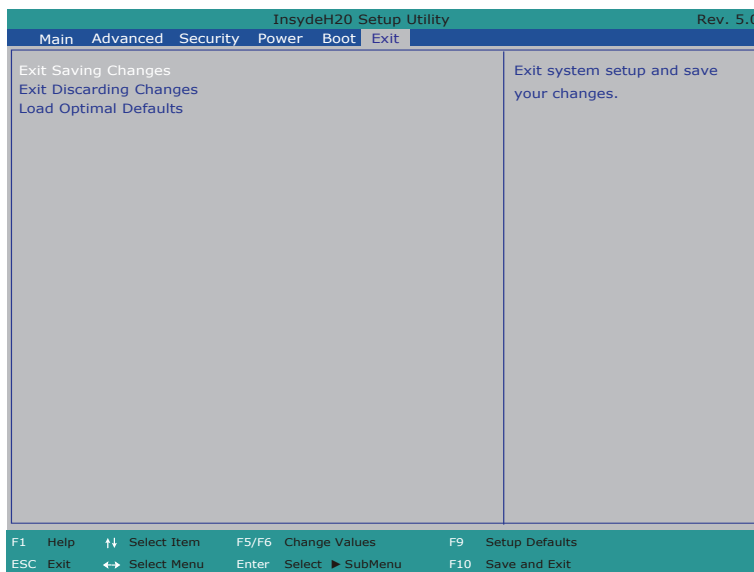

The **Exit** screen provides the following options:

Settings	Descriptions
Exit Saving Changes	Save the changes and exit the BIOS Setup Utility.
Exit Discard Changes	Exit the BIOS Setup Utility without saving the change(s).
Load Optimal Defaults	Restores all settings to defaults. After selecting this item, a dialog box will pop up to confirm your choice.

Appendix

A. Using the Vehicle Cradle (Optional)

A.1 Overview

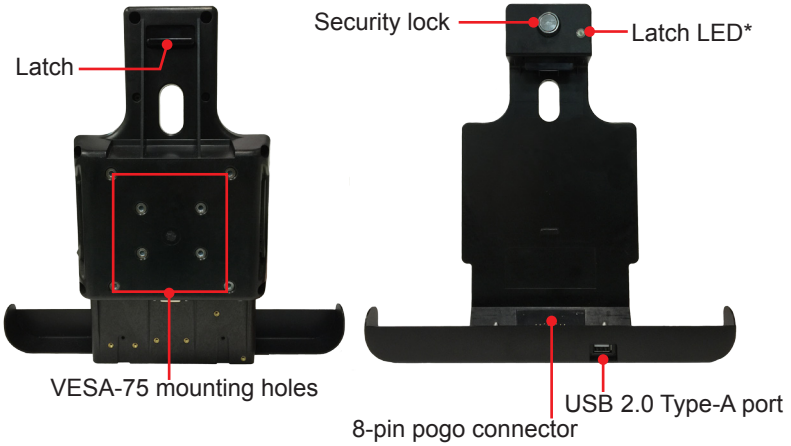

*The LED works when the cradle is connected to a power source:
On: Latch is fully engaged
Off: Latch is released

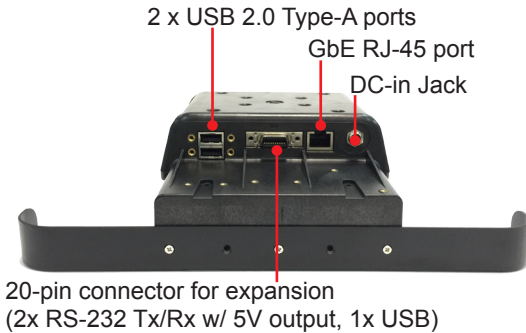

RS-232 Pin Assignment

Pin	Description
1	-
2	RXD
3	TXD
4	-
5	GND
6	-
7	-
8	-
9	+5V

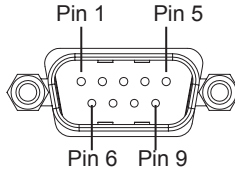

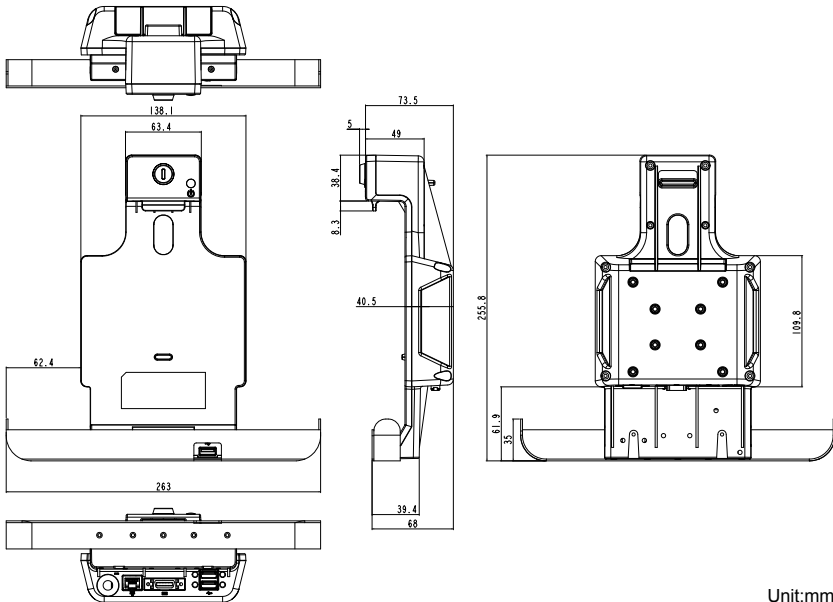

A.2 Dimensions



Unit:mm

A.3 Specifications

Specifications	
Color	Black
I/O Ports	3 x USB 2.0/1.1 Type-A port -2 x USB 2.0/1.1 Type-A port (rear) -1 x USB 2.0/1.1 Type-A port (front)
	1 x 2.5Φ DC-IN Jack
	1 x GbE LAN
	1 x 20 pin connectors for expansion (2x RS-232 Tx/Rx w/ 5V output, 1x USB)
Mechanical & Environmental	
Operating Temp.	0 ~ 45°C (32 ~ 113°F)
Storage Temp.	-20 ~ 60°C (-4 ~ 140°F)
Operating Humidity	10 ~ 95% @ 45° (non-condensing)
Dimensions (WxHxD)	263 x 255.8 x 68 mm (10.35" x 10.07" x 2.68")
Weight (Net)	673 g (1.49 lb)
Vibration	5 to 500Hz, 3 Grms (Random)
Shock	75 Grms
Chasis	
Expansion	Support VESA-75 & RAM-BALL
Security	Latch w/Key
Power	
Power-In	DC 19V / 20V
Accessory	
Cable	20 pin to DB9M x 2 + USB x 1 Ribbon Cable 
Ordering Information	
VMC-0975	Vehicle Cradle for G0975
Power Adapter	19V, 3.42A, 65W AC/DC Adapter Kit 
	20V, 3.6A, 72W Car Adapter Kit 

A.4 Installing the Vehicle Cradle

The installation of the vehicle cradle comprises three parts:

1. Dock the G0975 to the vehicle cradle and connect the vehicle cradle to a power source.
2. Power on the G0975 and install the vehicle cradle driver.
3. Mount the vehicle cradle to your vehicle and connect your peripherals to the cradle.

Make sure to follow the steps below to install the vehicle cradle.

A.4.1 Docking the G0975 to the Vehicle Cradle

1. With screen side facing out, insert the bottom of the G0975 into the docking cradle. Make sure to align with the guide posts on the cradle.



2. Push the top of the G0975 firmly into the cradle side.



3. Press the latch downward firmly until it is fully engaged.

The cradle comes with a latch LED. If the cradle is powered on when the latch is engaged, the LED will light up.

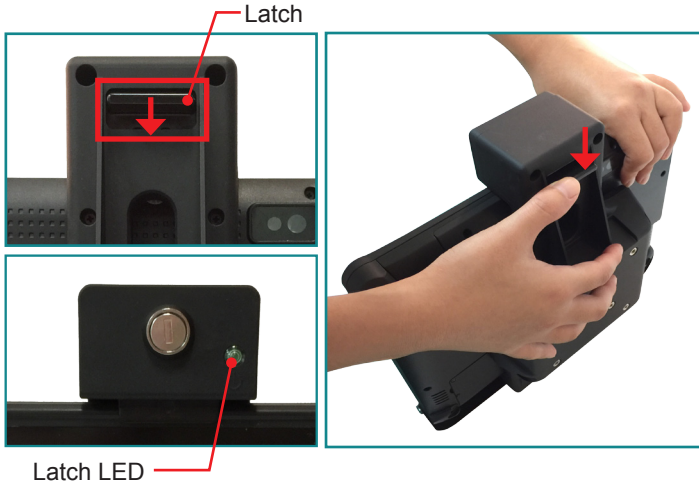

4. To lock the G0975, insert the provided key into the key slot and turn it counterclockwise to lock it and then remove the key.

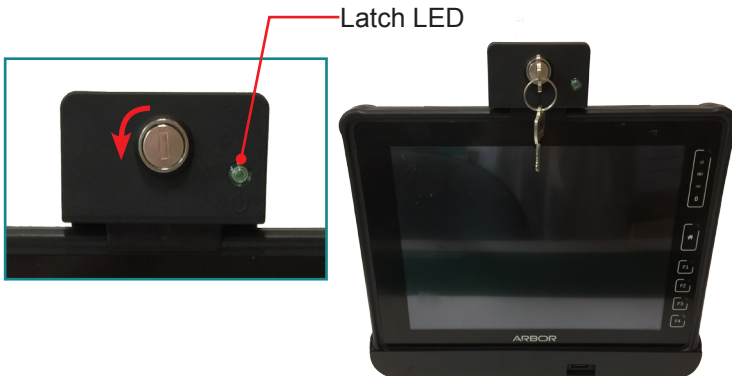

Important: To remove the G0975 from the cradle, make sure the latch LED is off and the latch is unlocked before proceeding to prevent any damage to G0975 and the cradle.

5. Connect the DC-IN jack on the cradle to a power source using the AC/DC power adapter (19V/3.42A 65W AC/DC adapter kit).



A.4.2 Installing the Vehicle Cradle Driver

To use the vehicle cradle (VMC-0975) with the G0975, you have to install the VMC-0975 drivers using the G0975 CD-ROM. Before proceeding, make sure you have docked the G0975 to the vehicle cradle and connect the cradle to a power source so that the G0975 can detect the I/O ports on the cradle.

1. Power on the G0975. Connect the CD-ROM drive and launch the driver installation menu screen as described in [2.5 Driver Installation](#) on page [25](#).
2. On the Autorun screen, tap **Cradle Driver**.



3. On the VMC/DTC screen, tap **USB LAN** according to your operating system to install the Gigabit LAN port driver. Just follow the on-screen instructions to proceed.



4. Continue to install the serial port drivers. As the cradle supports two serial ports through the Pogo connector, you will have to separately install the driver for the two serial ports.
5. Tap **Start > Control Panel > Hardware and Sound > Device Manager**.
6. Expand **Other devices** and locate the **Dual RS232-HS** item. Right-click the **Dual RS232-HS** item and select **Update Driver Software**.

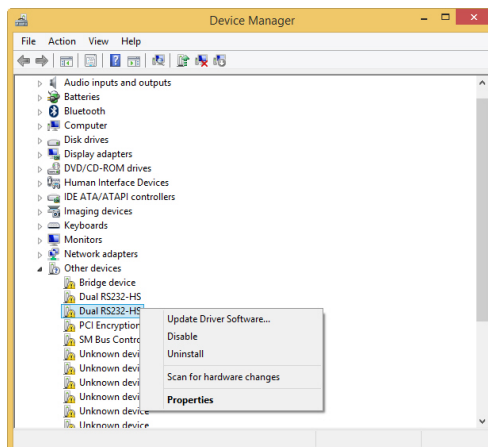

7. Select **Browse my computer for driver software**.

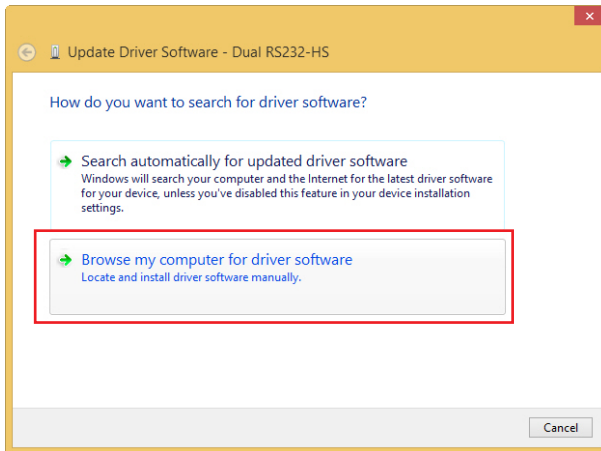

8. Tap **Browse** to locate the driver under the following path.

disk drive:\Driver\Cradle\VMC\Your Operating System\USB to UART

Check the **Include subfolders** checkbox and then tap **Next**.

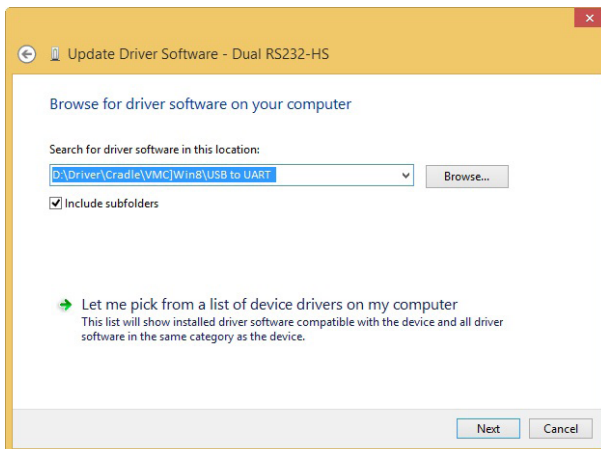

9. When the driver installation is finished, tap **Close**.

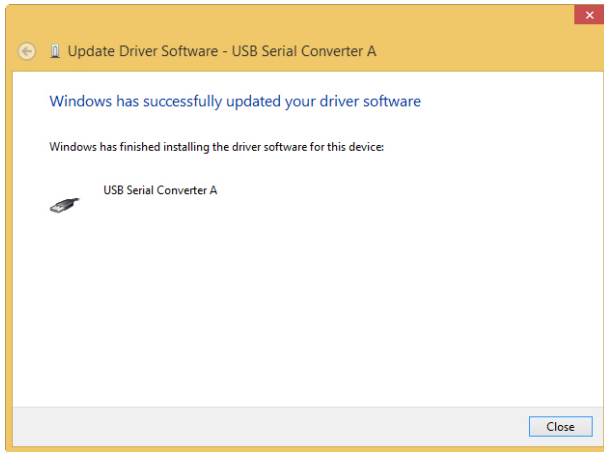

10. In the **Device Manager**, locate another **Dual RS232-HS** item and repeat steps 6~9 to install the driver for another serial port.
11. Still in the **Device Manager**, expand **Other devices** and you will find two **USB Serial Port** items. Right-click one of the **USB Serial Port** items and select **Update Driver Software**.

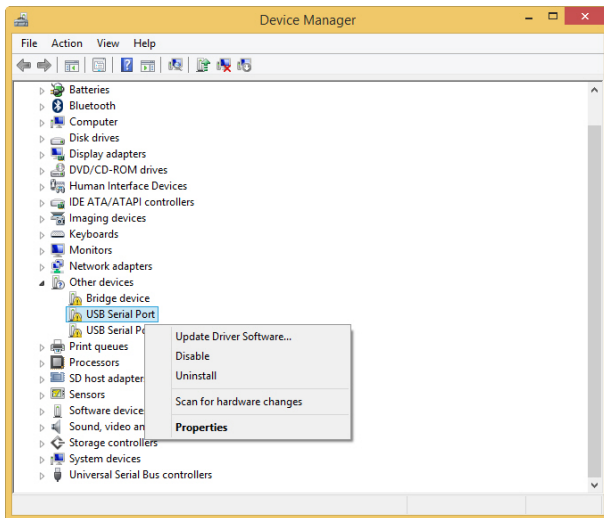

12. Select **Browse my computer for driver software**.

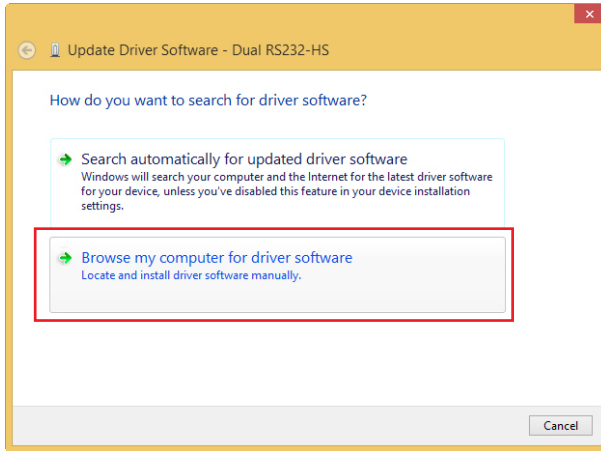

13. Tap **Browse** to locate the driver under the following path.

disk drive:\Driver\Cradle\VMC\Your Operating System\USB to UART

Check the **Include subfolders** checkbox and then tap **Next**.

14. When the driver installation is finished, tap **Close**.

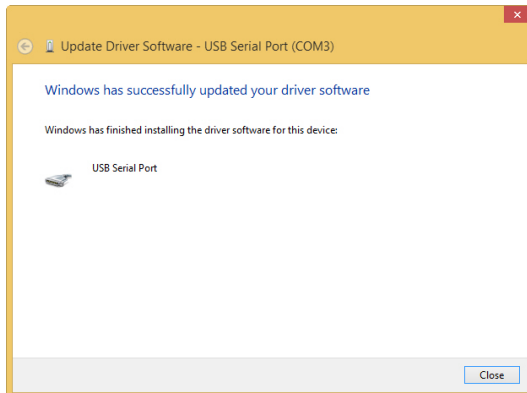

15. Repeat steps 11~14 to install the driver for another USB serial port.

16. When the installation is complete, you should be able to see two **USB Serial Ports** under the **Ports (COM & LPT)** group in the **Device Manager**.

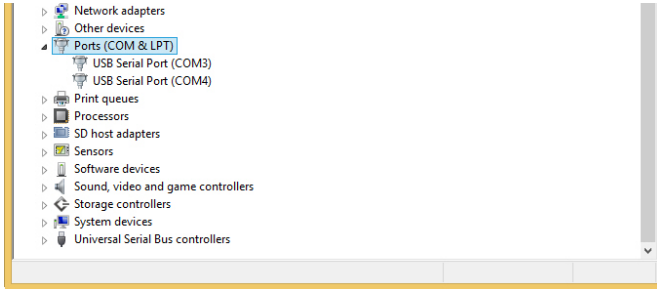

A.4.3 Mounting the Cradle to a Vehicle

After installing the drivers, you are ready to mount the cradle with G0975 to your vehicle using the VESA-75 mounting holes.

To use the I/O ports on the cradle, the cradle has to be connected to a power source. Using the provided car adapter kit, connect one end to the DC-IN jack on the cradle and the other end to the cigarette lighter socket.

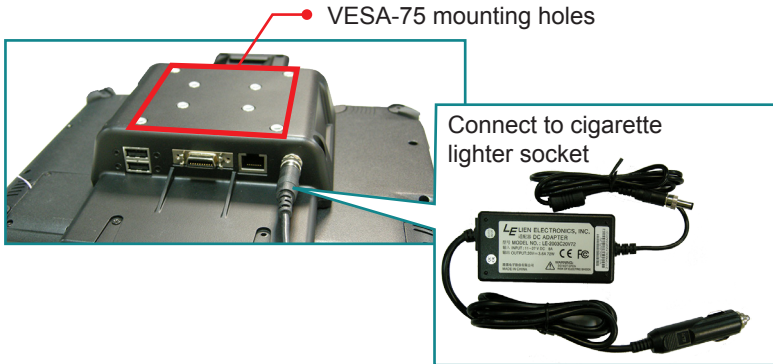

A.4.4 Connecting the Peripherals to the Cradle

Refer to the figure below to connect the peripherals as needed to the cradle:

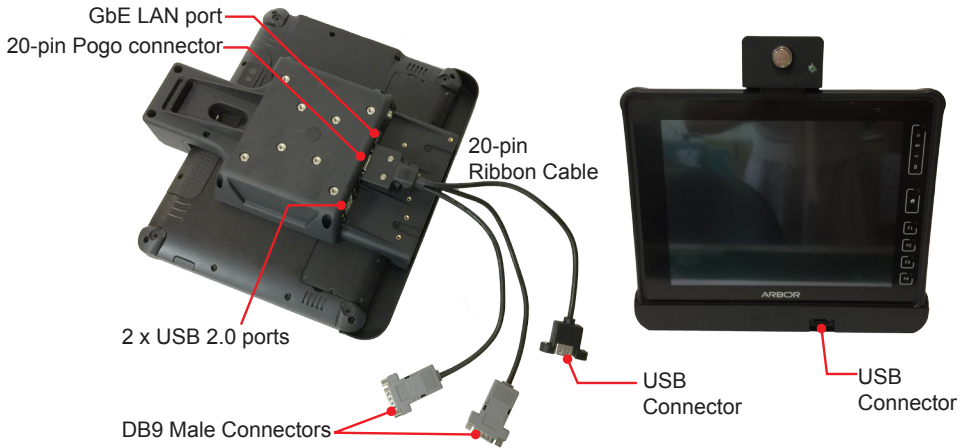

A.5 Removing the G0975 from the Vehicle Cradle

To remove the G0975 from the cradle

1. If the G0975 is locked, insert the provided key into the key slot and turn it clockwise to unlock it.

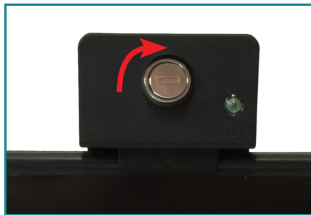

2. Lift the latch upwards to release it. If the cradle is connected to a power source, the LED should be off to indicate the latch is released.

Important: Make sure the latch LED is off and the latch is unlocked before removing the G0975; otherwise the G0975 and the cradle may be damaged.

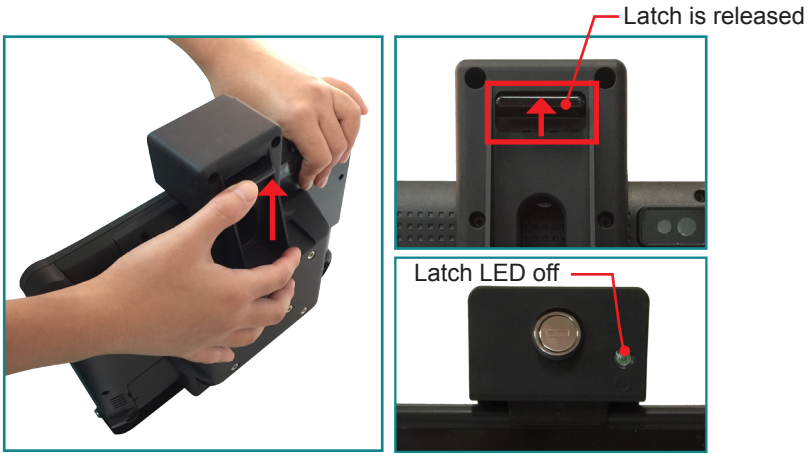

3. Then you can remove the G0975 from the cradle.

B. Using the Desktop Cradle (Optional)

B.1 Overview

DTC-0975

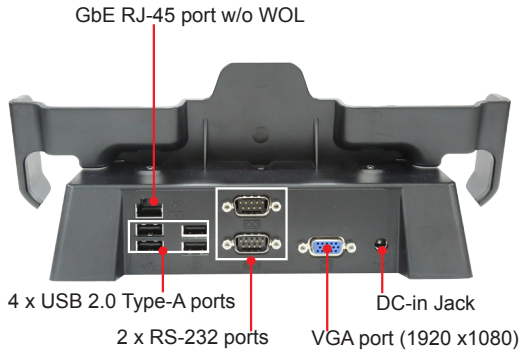

DTC-0975M

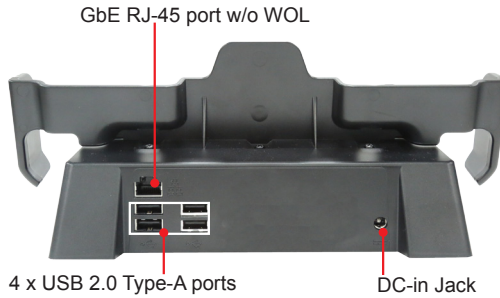

B.2 Specifications

Color & Material	Black
I/O Ports	4 x USB 2.0 ports
	2 x RS-232 ports (only on DTC-0975)
	1 x Ethernet 10/100/1000 RJ-45 w/o WOL
	1 x DC-in Jack
	1 x VGA port (1920x1080 resolution) (only on DTC-0975)
Mechanical & Environmental	
Operating Temp.	-20 ~ 45°C (-4 ~ 113°F)
Storage Temp.	-20 ~ 60°C (-4 ~ 140°F)
Dimensions (W x H x D)	270 x 109 x 114 mm (10.63" x 4.29" x 4.49")
Weight (Net)	640g (1.41 lb)
Vibration	1 Grms/ 5 ~ 500Hz/ random operation
Shock	10G peak acceleration (11 ms duration)
Power	
Adapter Input	100~240VAC (Full Range)
Adapter Output	19V, 3.4A, 65W
Ordering Information	
DTC-0975	Desktop Cradle for Gladius G0975/G0975M
DTC-0975M	Desktop Cradle for Gladius G0975/G0975M

B.3 Dimensions

DTC-0975

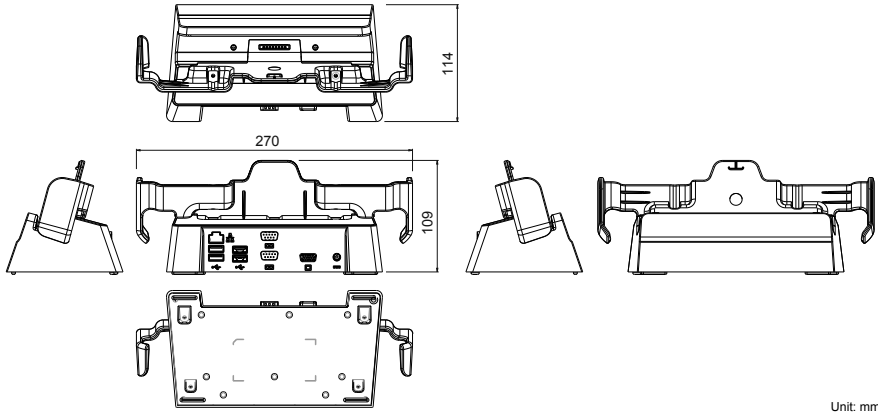

Unit: mm

DTC-0975M

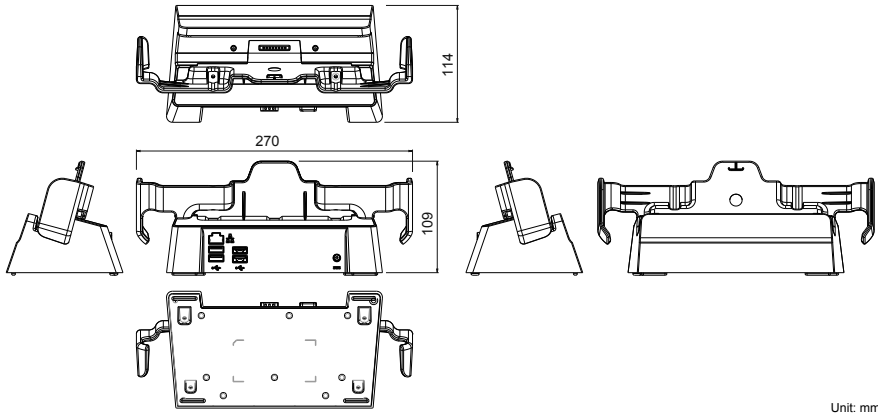

Unit: mm

B.4 Installing the Desktop Cradle

The installation of the desktop cradle comprises three parts:

1. Dock the G0975 to the desktop cradle and connect the cradle to a power source.
2. Power on the G0975 and install the desktop cradle driver.
3. Connect your peripherals to the cradle as needed.

Make sure to follow the steps below to install the desktop cradle.

B.4.1 Docking the G0975 to the Desktop Cradle

To dock the G0975 series, with screen side facing out, insert the bottom of the G0975 into the desktop cradle. Make sure to align with the guide posts on the cradle.



4. Connect the DC-IN jack on the cradle to a power source using the AC/DC power adapter (19V/3.42A 65W AC/DC adapter kit).



B.4.2 Installing the Desktop Cradle Driver

To use the desktop cradle (DTC-0975/0975M) with the G0975 series, you have to install the DTC-0975/G0975M drivers using the G0975 CD-ROM. Before proceeding, make sure you have docked the G0975 to the desktop cradle and connect the cradle to a power source so that the G0975 series can detect the I/O ports on the cradle.

Follow the instructions below to install the driver for the Giga LAN, VGA and the serial ports. (For DTC-0975M, ignore the sections of VGA and serial ports.)

1. Power on the G0975. Connect the CD-ROM drive and launch the driver installation menu screen as described in [2.5 Driver Installation](#) on page [25](#).
2. On the Autorun screen, tap **Cradle Driver**.



3. On the VMC/DTC screen, tap **USB LAN** according to your operating system to install the Gigabit LAN port driver. Just follow the on-screen instructions to proceed.



4. Continue to install the VGA driver. On the VMC/DTC screen, tap **USB to VGA (Win7/Win8)** to install the VGA driver. Just follow the on-screen instructions to proceed.

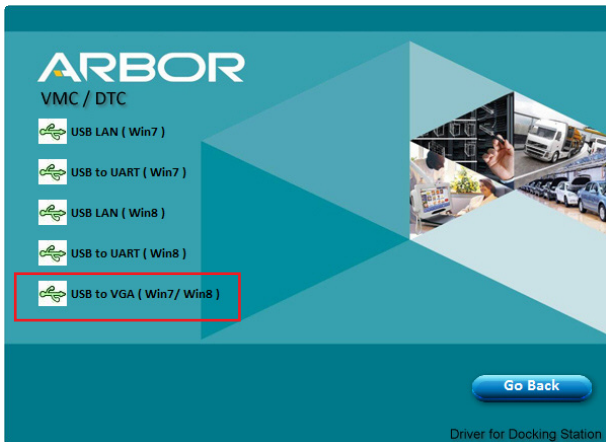

5. Continue to install the serial port drivers. As the cradle supports two serial ports through the Pogo connector, you will have to separately install the driver for the two serial ports.
6. Tap **Start > Control Panel > Hardware and Sound > Device Manager**.

- Expand **Other devices** and locate the **Dual RS232-HS** item. Right-click the **Dual RS232-HS** item and select **Update Driver Software**.

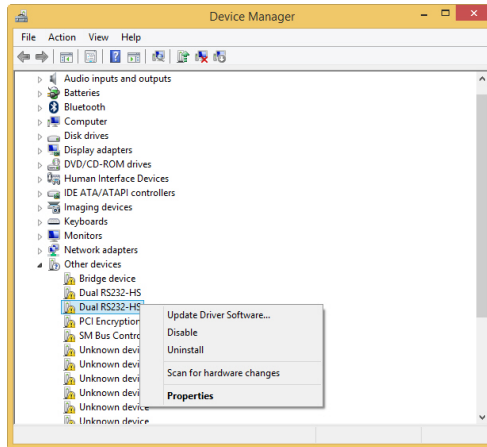

- Select **Browse my computer for driver software**.

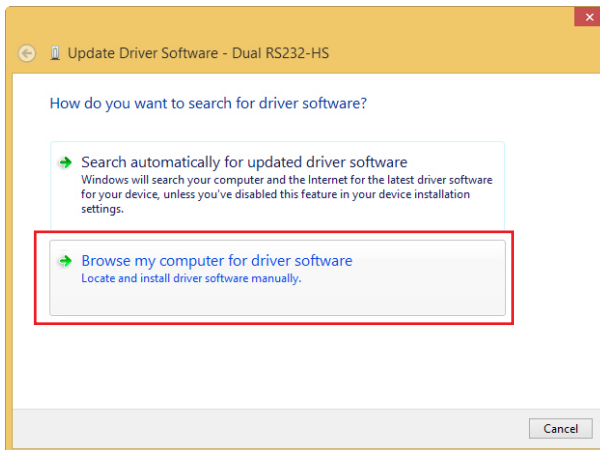

- Tap **Browse** to locate the driver under the following path.
disk drive:\Driver\Cradle\VMC\Your Operating System\USB to UART
 Check the **Include subfolders** checkbox and then tap **Next**.

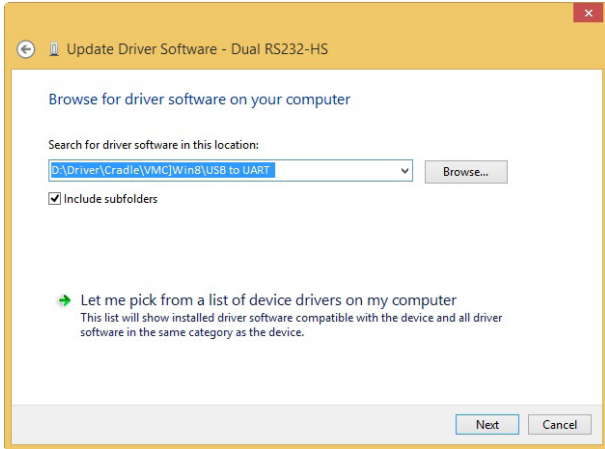

10. When the driver installation is finished, tap **Close**.

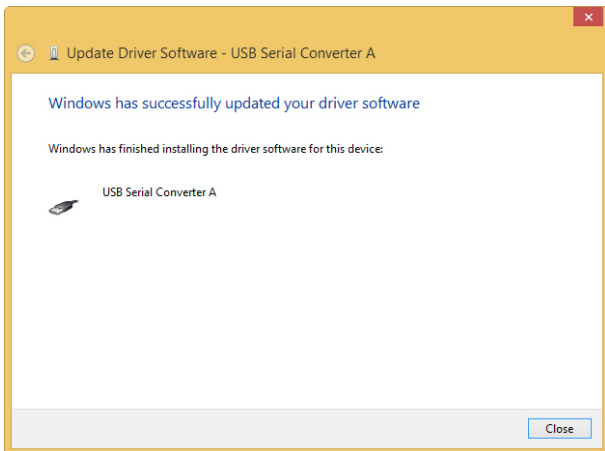

11. In the **Device Manager**, locate another **Dual RS232-HS** item and repeat steps 7~11 to install the driver for another serial port.

12. Still in the **Device Manager**, expand **Other devices** and you will find two **USB Serial Port** items. Right-click one of the **USB Serial Port** items and select **Update Driver Software**.

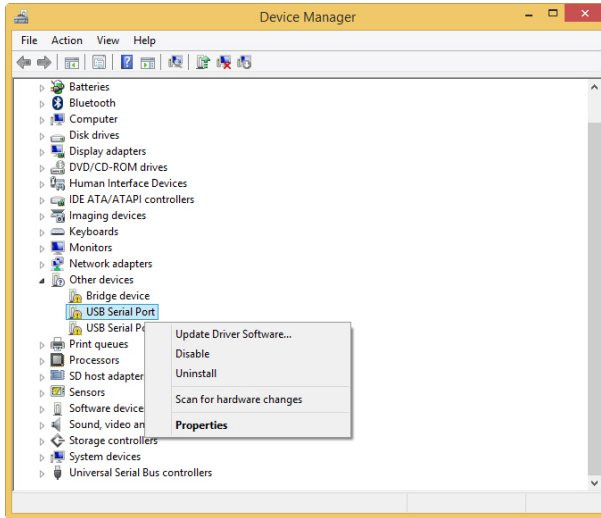

13. Select **Browse my computer for driver software**.

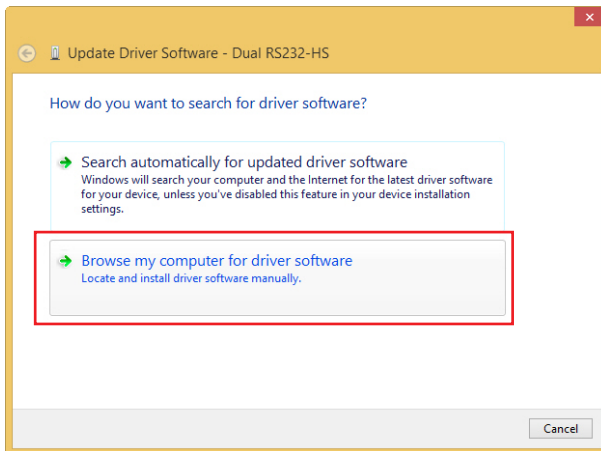

14. Tap **Browse** to locate the driver under the following path.

disk drive:\Driver\Cradle\VMC\Your Operating System\USB to UART

Check the **Include subfolders** checkbox and then tap **Next**.

15. When the driver installation is finished, tap **Close**.

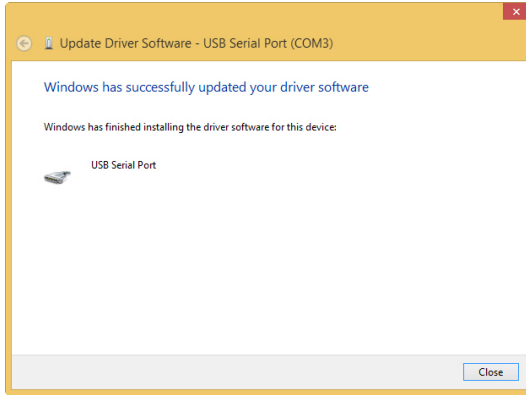

16. Repeat steps 12~15 to install the driver for another USB serial port.

17. When the installation is complete, you should be able to see two **USB Serial Ports** under the **Ports (COM & LPT)** group in the **Device Manager**.

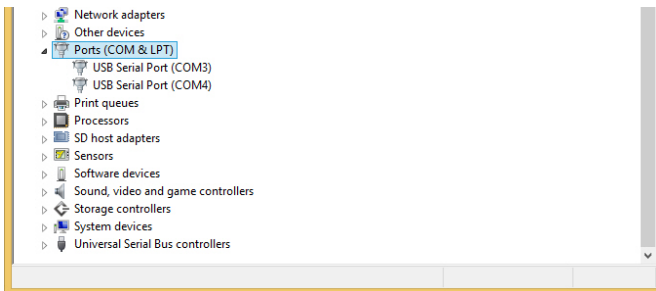

Then you can connect the peripherals as needed to the cradle.